

Supplemental Supporting Information for a Finding of Effect

[DRAFT PUBLIC COMMENT COPY]

Project: Warren 27036.00

Scope: Roundabout Construction

Finding of Effect: No Adverse Effect

This report describes the Maine Department of Transportation's compliance with Section 106 of the National Historic Preservation Act (36 CFR Part 800). It details the finding of effect to historic properties listed in or eligible for listing in the National Register of Historic Places (NRHP) that are located in the subject project's Area of Potential Effect (APE). This report also assesses how the proposed project may directly or indirectly affect and/or diminish those characteristics and aspects of integrity that qualify a historic property for inclusion in the NRHP. This report is specific to the Section 106 assessment of effects, as opposed to general environmental impacts. Consultation with coordinating agencies and the public is ongoing.

Project Scope

The proposed project consists of the installation of a roundabout at the intersection of Route 90 and Western Road in Warren, Knox County.

Purpose and Need

The purpose of this project is to improve safety at the intersection of Route 90 and Western Road in Warren.

There is a safety concern at the intersection due to the uncontrolled approaches on Route 90 – a high-speed roadway – and lack of dedicated left turn lanes. Stop signs are located on the minor street, Western Road. Crash data was gathered over a seven-year period beginning in 2014 and ending in 2021. The total number of crashes recorded during the analysis period was 30, with one fatal crash and two serious crashes. The Critical Rate Factor was 3.24 versus a state average of 0.13 and the intersection is 5th in the state in 50 mph and angle crashes among minor road stop intersections. There has been a fatal crash and separate serious injury crash at this intersection since electronic crash data started in 2003.

Proposed Action

The proposed action would convert the existing minor street stop-controlled intersection to a modern roundabout. The project would include full depth reconstruction of the approaches, installation of green-painted asphalt splitter islands, truck aprons, a landscaped central island, new slipform concrete curbing along the approaches and medians, drainage improvements, new street lighting, and new signage. Lighting improvements would include new light fixtures mounted on breakaway pole assemblies to illuminate the roundabout approaches and central median island and alert motorists of the upcoming roundabout. Shoulder improvements would include reconstruction and narrowing of the existing shoulders within the limits of the splitter islands. Geometric improvements would also be incorporated into the project as a means of decreasing driver speeds as they approach the roundabout. The roundabout alternative was chosen as the preferred option because it would provide the highest safety benefit, significantly reduce the possibility of fatal and severe injury crashes, provide the highest level of service for traffic operations, and reduce vehicle emissions.

Federal Action

Federal funding.

Definition of Area of Potential Effect (APE)

The proposed project is located in Warren, Knox County, Maine. The map below shows the APE.

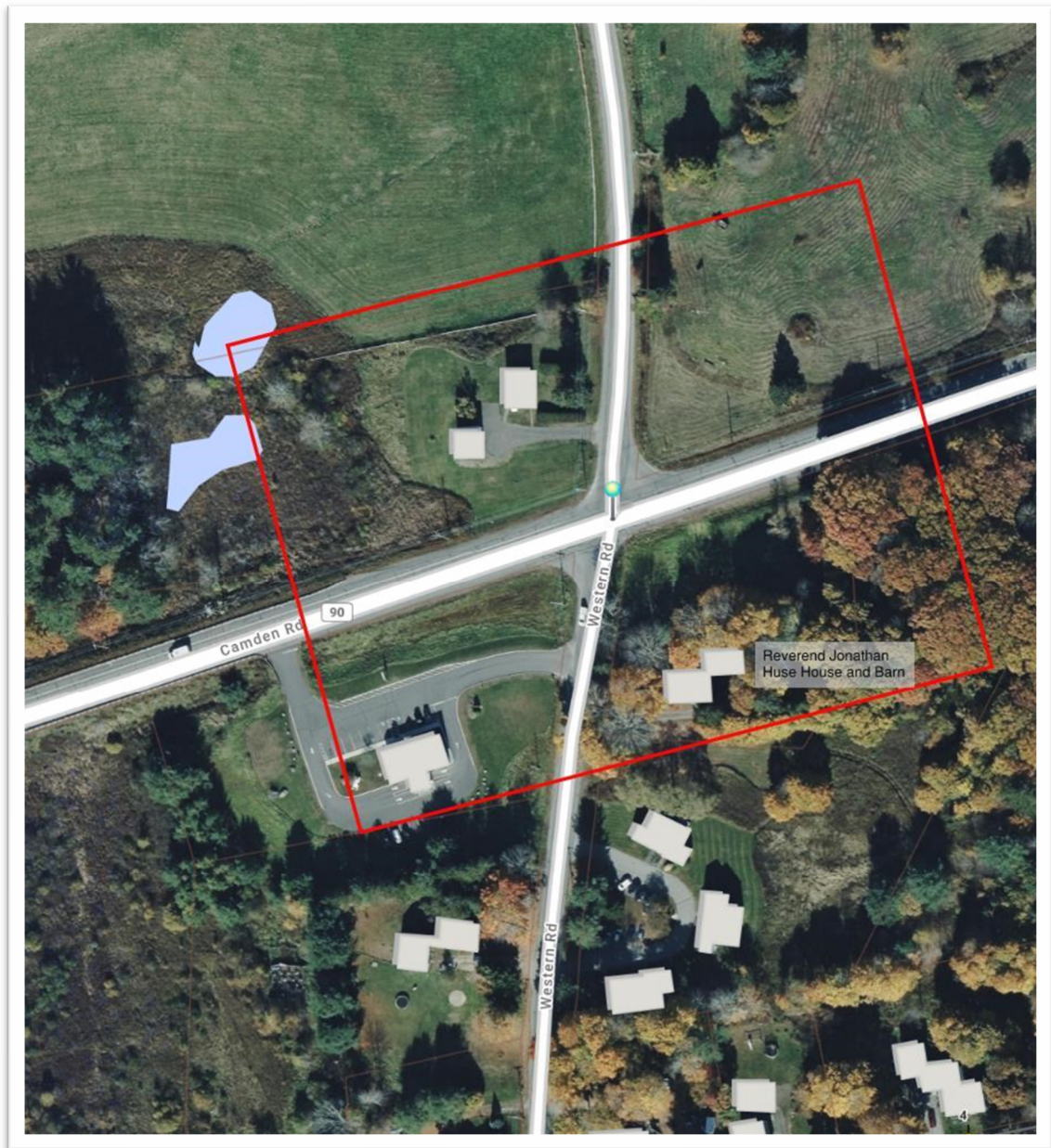

Figure 1. Warren 27036.00 Area of Potential Effect

Historic Properties

The proposed project is located in Warren. The description is based on a Maine Historic Preservation Commission (MHPC) form.

Reverend Jonathan Huse House and Barn, 283 Western Road (Boggs, Robin E.: Sta. 21+00 to 23+50 Right, Sta. 14+50 to 17+50 Right)***National Register-Eligible
Criteria C, Architecture***

The Reverend Jonathan Huse House and Barn are eligible for listing in the National Register under Criterion C, Architecture, as good examples of the Federal style on the local level. The center chimney house is a two-story, clapboard sided structure that is seated on a fieldstone foundation and topped with a hipped roof. It has a double pile plan. The façade is five bays wide with a central doorway that is crowned with an elliptical fanlight. The windows and door have simple wood trim with molded headers. A side gable one-story story ell extends off the northeastern corner and connects to a side gabled barn.

Huse was a native of Methuen, Massachusetts, and preached at the church that was located at the intersection of Main Street and Western Road, just 1/10 of a mile south of his home. The house is representative of the Federal style, with its symmetrical façade, relatively small windows, simple trim, and low angled roof. The house was constructed c.1801 and the barn shortly after (it was rebuilt at an unknown date). The period of significance is c.1801-1820.



Figure 2. Reverend Jonathan Huse House, courtesy of Penobscot Marine Museum

Archaeological Resources

There are no archaeological resources in the project area.

Impacts to Property

The following addresses potential impacts to properties as a result of the proposed action.

Reverend Jonathan Huse House and Barn, 283 Western Road (Boggs, Robin E.: Sta. 21+00 to 23+50 Right, Sta. 14+50 to 17+50 Right)

National Register-Eligible Criteria C, Architecture

The proposed action would result in **No Adverse Effect** to the Reverend Jonathan Huse House and Barn. The proposed action would construct a roundabout at the intersection located just northwesterly of the historic property. Construction would impact the land located behind the house and barn, resulting in a permanent land acquisition for the roundabout. Additionally, approach work adjacent to the historic property on Western Road would require some grading and minor clearing of vegetation. This work would require temporary construction rights. The larger growth trees that run the length of the property on Western Road would be avoided.

The construction of the roundabout would not significantly diminish the integrity of the Reverend Jonathan Huse House and Barn, as the roundabout would be installed behind the historic property, thus avoiding major impacts to the setting, feeling, and association. Furthermore, existing trees that provide a visual buffer between the historic buildings and both Western Road and Route 90 would be avoided during construction. The overall size of the roundabout is approximate to the existing four-way intersection, and the area is already defined by hardscape, therefore the new construction and addition of medians, curbing, and island would not significantly alter the setting.

Archaeological Resources

There are no archaeological resources in the project area.

Avoidance and Minimization Efforts

The proposed action avoids and minimizes adverse effects by avoiding trees and vegetation that provide a visual buffer between the historic property and the road, minimizing the introduction of materials that are not currently found at the project location, and minimizing direct impacts to the historic property to the greatest extent possible while still meeting the project's purpose and need.

Dismissed Alternatives

Three additional alternatives were analyzed as part of the preliminary engineering of this project:

No Build

The No Build alternative would take no action and does not meet the purpose and need of the project and was, therefore, removed from further consideration.

Traffic Signal

The Traffic Signal alternative would replace the existing intersection with a standard traffic signal. The traffic signal warrants were met for this alternative, and the incremental benefit cost-analysis was slightly higher than the roundabout alternative, and significantly higher than the Two "T" intersections alternative. This alternative was ultimately dismissed due to the roundabout alternative being similar in incremental benefit-cost analysis while providing additional benefits that are not possible with the traffic signal.

"T" Intersections

The "T" Intersections alternative would replace the existing intersection with two "T" intersections. The Route 90 approaches would remain unchanged, with free-flowing traffic along Route 90 in each direction, plus the addition of dedicated left turn lanes to Western Road. The southern approach would be slightly revised to remove the skew at the intersection and approach Route 90 at a 90-degree angle. The northern approach would be realigned to intersect with Route 90 further to the

east. This alternative would likely reduce rear-end collisions but would not improve angle crashes and wouldn't satisfy the overall intent of the safety improvements for the project. There are also potential sight distance issues for the northern approach due to the existing grade of Route 90. For these reasons, this alternative was dismissed.

Public Involvement

MaineDOT contacted the four federally recognized tribes in Maine about this project. The Passamaquoddy Tribe and Penobscot Nation replied with no concerns.

The Town of Warren was contacted by email in 2023 and asked to comment on knowledge of, or concerns with, historic properties in the area, and any issues with the undertakings effect on historic properties. The Town replied and stated no concerns.

Formal public meetings were held via virtual public involvement in November 2023 and May 2025. There were no public comments related to the historic review or impacts to the historic property.

The public process is ongoing.

Proposed Materials

Hot mix asphalt, concrete, concrete slipform curb, guardrail, loam and seed (and additional landscaping materials)

Plans

Warren, Knox County, Route 90 at Western Road, Federal Project No. 2703600

Attachments

J. N. Leith Smith, MHPC, to Julie Senk, MaineDOT, May 23, 2023

Kirk Mohney, MHPC, to Julie Senk, MaineDOT, June 11, 2024

STATE OF MAINE
Memorandum

Date: May 23, 2023

To: Julie Senk, Historic Preservation Coordinator, Maine DOT/ENV

From: J. N. Leith Smith, MHPC

Subject: Archaeology Review

Project: MHPC #0628-23, WIN 27036: Warren
Installation of roundabout at intersection of Route 90 and Western Road.

Dear Julie,

After reviewing our archaeological survey records and maps, including historic maps and surficial geology maps, and comparing this information with a predictive model of archaeological site locations, we find that no archaeological fieldwork is necessary for the project referenced above, based on the project location and general project description information provided May 5th, 2023. It is extremely unlikely that an archaeological site would be affected by this project, in our opinion.

In following the procedures specified in the Federal Highway/MHPC/MDOT programmatic agreement, we **recommend a finding that there will be no archaeological properties affected by the proposed undertaking.**

STATE OF MAINE

Memorandum

Date: June 3, 2024

To: Kirk F. Mohnney, MHPC
From: Julie Senk, Maine DOT/ENV
Subject: Section 106 request for concurrence
Project: Warren 27036.00, MHPC #0628-23
Scope: Roundabout construction

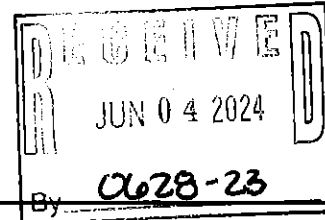

The Maine DOT has reviewed this project pursuant to the Maine Programmatic Agreement (PA) and Section 106 of the National Historic Preservation Act of 1966, as amended.

The proposed project is roundabout construction at the intersection of Camden Road/Route 90 and Western Road in Warren.

In accordance with 36 CFR Part 800.4, the following identification efforts of historic properties were made:

- 800.4(a) (1) – The Area of Potential Effect (APE) includes properties/structures adjacent to the intersection and within the project limits. The project limits are defined by the intersection and the immediately adjacent area. Properties/structures adjacent to this project limit are considered to be within the APE. The APE is shown as a red polygon on the attached map.
- 800.4(a) (2) – Review of existing information consisted of researching the National Register and MHPC survey databases. The Maine Historic Preservation Commission staff have reviewed the undertaking.
- 800.4(a) (3) – The Town of Warren, along with applicable historical societies, were contacted via email and asked to comment on knowledge of, or concerns with, historic properties in the area, and any issues with the undertaking's effect on historic properties. The Town was also requested to provide information regarding local historic societies or groups. The Town Assessor's Agent replied with information on historic properties.
- 800.4(a) (4) – Emails outlining project location and scope were sent to the 4 federally recognized Tribes in Maine. The Passamaquoddy Tribe and the Penobscot Nation replied with no concern.
- 800.4(c) – The Maine DOT conducted historic architectural surveys within the APE to determine if properties met National Register criteria. Maine Historic Preservation Commission Archaeological staff has reviewed the undertaking and recommended "a finding that there will be no archaeological properties affected by the proposed undertaking." **The MaineDOT has determined that two architectural properties are eligible for listing in the National Register.**

In accordance with the PA and 36 CFR Part 800, please reply with your concurrence or objection to the determination of eligibility for listing in the National Register of Historic Places within 30 days. If more information is deemed necessary, please supply a list of the specific resources in question.

Please contact me at Julie.Senk@maine.gov or 592-3486 if you have any questions. Thank you.

cc: CPD e-file

enc: Architectural survey package; J. N. Leith Smith, MHPC to Julie Senk, MaineDOT, May 23, 2023

CONCUR
Kirk F. Mohnney
Kirk F. Mohnney,
State Historic Preservation Officer
6/11/24
Date

STATE OF MAINE DEPARTMENT OF TRANSPORTATION



WARREN KNOX COUNTY ROUTE 90 AT WESTERN RD FEDERAL PROJECT NO. 2703600 PROJECT LENGTH: 0.28 MILES RECONSTRUCTION

PLAN LEGEND

Town, County, State	-----	Catch Basins	▣ Existing	⊙ Proposed
Property Lines	-----	Manholes	⊙ Existing	● Proposed
R/W Lines-Existing	-----	Proposed Underdrain	→	
R/W Lines-Proposed	-----	Proposed Ditch	→	
Culvert-Existing	-----	Existing Ditch	→	
Culvert Proposed	-----	Utility Poles	⊕ Existing	⊕ Proposed
Curbing	-----	Fire Hydrants	⊕ Existing	⊕ Proposed
Type 1	-----	Existing Water Line	---W---	
Type 3	-----	Existing San. Sewer	---S---	
Type 5	-----	Existing San. Sewer Manhole	⊙	
Outline of Bodies of Water	-----	Guardrail-Existing	-----	
Exposed Bedrock	-----	Guardrail-Proposed	-----	
Buildings	-----	Centerline-Existing	-----+10+00	
Trees	-----	Centerline-Proposed	-----+10+00	
Conifer	-----	Travelway-Existing	-----	
Deciduous	-----	Travelway-Proposed	-----	
Tree Line	-----			
Clearing Limit Line	-----			
Railroad	-----			
Boring	⊕	Probe	⊕	P-#. #X
Pavement Core	●			#.# = Depth
Test Pit	⊕			X = W (Weathered Rock)
				R (Refusal)
				NR (No Refusal)

INDEX OF SHEETS

Description	Sheet No.
Title Sheet	1
Typical Sections	2 - 4
Estimated Quantities	5
Drainage Sheet	6
General Notes	7
Construction Notes	8
Special Details - Central Truck Apron	9
Special Details - Drainage	10
Lighting Plans & Details	11-17
Striping Plans	18-21
Signing Plans	22-24
Sign Summary	25
Grading Plans	26-29
Geometric Plans	30-32
Plans	33-35
Profiles	36-39
Cross Sections	40-64

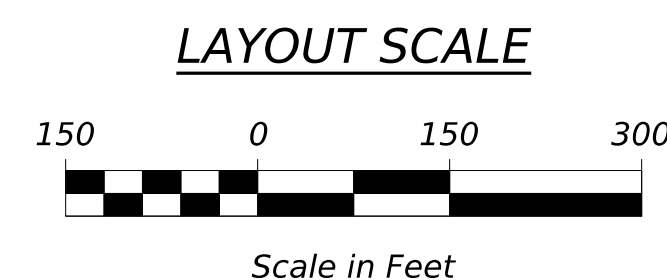
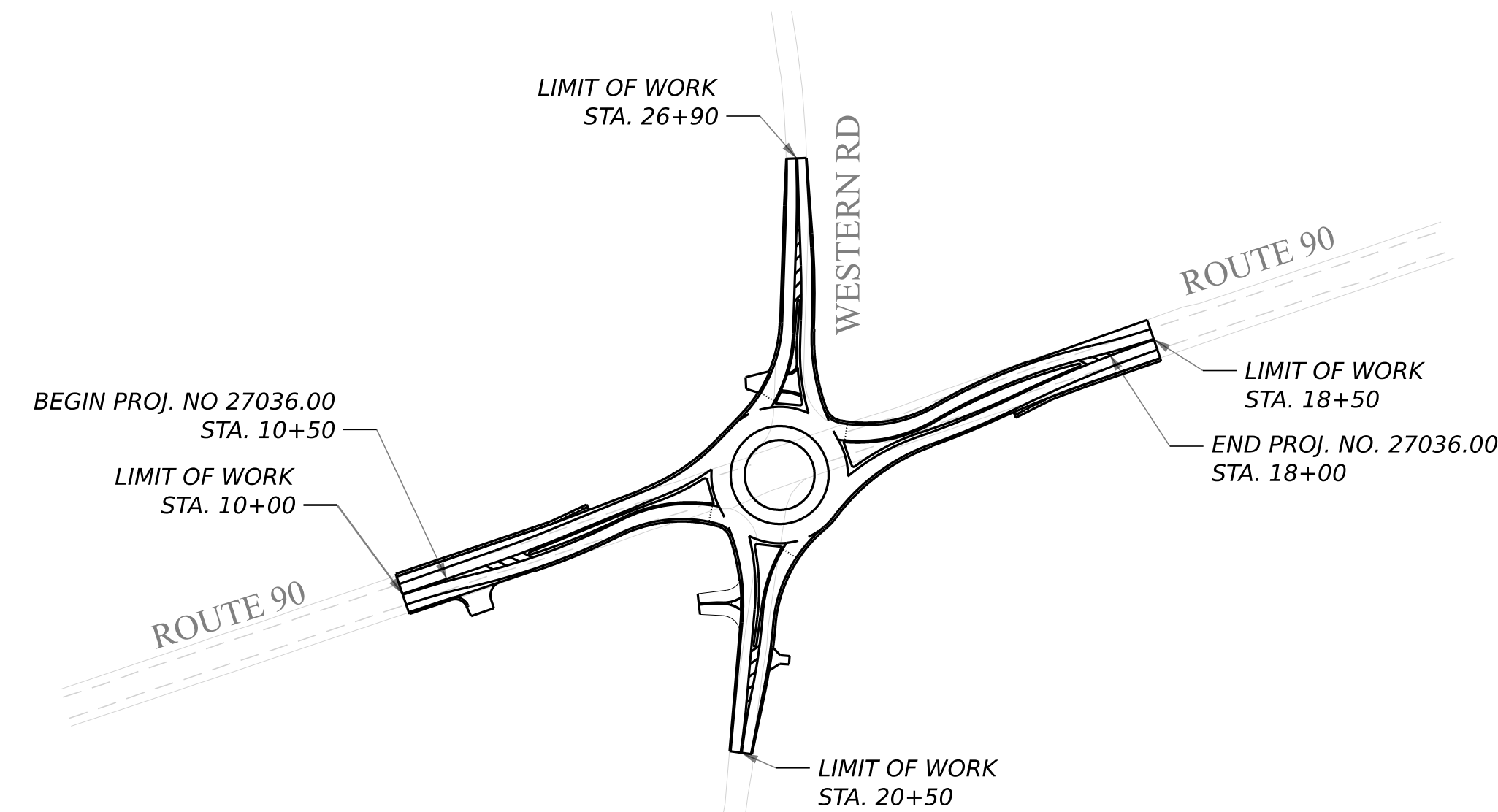

TRAFFIC DATA	ROUTE 90	WESTERN RD (NORTH)	WESTERN RD (SOUTH)
Current (2024) AADT	6,621	2,203	2,744
Future (2044) AADT	8,078	2,688	3,348
DHV - % of AADT	12%	12%	12%
Design Hour Volume	969	323	401
% Heavy Trucks (AADT)	X	X	X
% Heavy Trucks (DHV)	X	X	X
Directional Distribution (DHV)	X	X	X
18-kip Equivalent P 2.0	X	X	X
18-kip Equivalent P 2.5	X	X	X
Design Speed (mph)	50	35	25
Corridor Priority	2	5	5

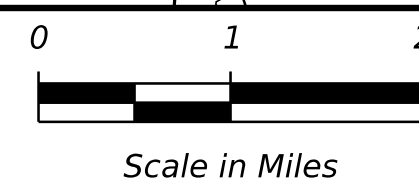
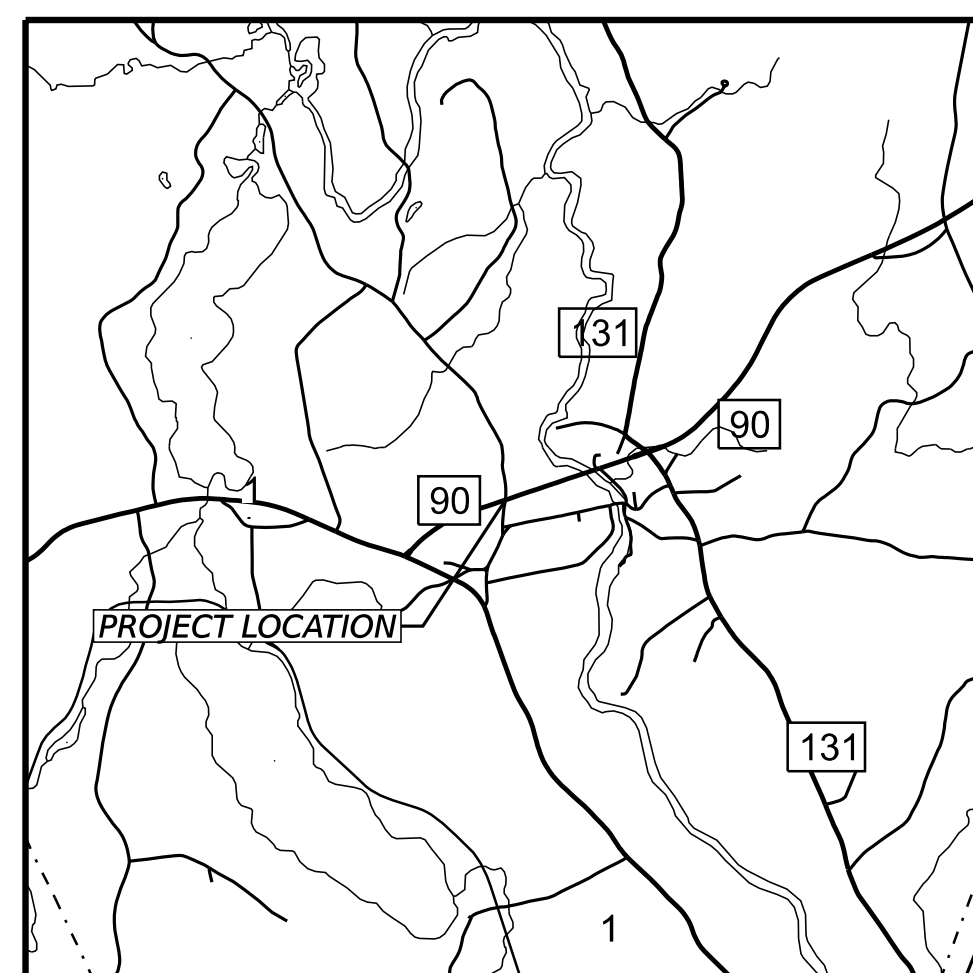

LOCATION MAP

PROJECT LOCATION:	TOWN OF WARREN, AT THE INTERSECTION OF ROUTE 90 AND WESTERN RD
PROGRAM AREA:	HIGHWAY PROGRAM
SCOPE OF WORK:	CONSTRUCTION OF ROUNDABOUT, FULL DEPTH APPROACHES, CURBING, DRAINAGE, SIGNING, STRIPING AND LIGHTING

STATE OF MAINE	APPROVED	DATE
DEPARTMENT OF TRANSPORTATION	COMMISSIONER:	CHIEF ENGINEER:

PROJECT INFORMATION	SIGNATURE	P.E. NUMBER	DATE
PROGRAM	DESIGNER	PROJECT RESIDENT	PROJECT COMPLETION DATE
HIGHWAY	PROJECT MANAGER	CONTRACTOR	
	CONSULTANT		

**WARREN
ROUTE 90 AT WESTERN RD
TITLE SHEET**

**SHEET NUMBER
1
OF 64**

XXXXXXXXXXXX

WIN 27036.00

PROJ. MANAGER	DATE	SIGNATURE
CHECKED/REVIEWED	DATE	P.E. NUMBER
DESIGN/DETAILS	DATE	DATE
REVISIONS 1		
REVISIONS 2		
REVISIONS 3		
REVISIONS 4		
FIELD CHANGES		

WARREN
ROUTE 90 AT WESTERN RD
TYPICAL SECTIONS

- NOTES:
1. THE PAVEMENT, BASE AND SUBBASE DEPTHS AS SHOWN ON THE PLANS ARE INTENDED TO BE NOMINAL.
 2. CROWNS FOR ALL COURSES OF SUBBASE AND PAVEMENT SHALL BE STRAIGHT.
 3. THE GRAVEL QUANTITY CALCULATION IS BASED ON A 4" LOAM DEPTH. THE ACTUAL DEPTH MAY VARY. SEE THE GENERAL NOTES.
 4. THE ALGEBRAIC DIFFERENCE BETWEEN THE SHOULDER AND TRAVEWAY CROSS SLOPES "ROLLOVER" SHALL NOT EXCEED 8%.
 5. THE STATIONING SHOWN UNDER EACH TYPICAL IS APPROXIMATE.
 6. AGGREGATE SUBBASE COURSE GRAVEL TYPE D VARIES FROM 0" TO 22" FROM THE LIMITS OF WORK TO THE BEGIN/END OF PROJECT.
 7. GUARDRAIL SECTIONS ARE NOT SHOWN. REFER TO PLANS AND CROSS SECTIONS FOR GUARDRAIL. SLOPES IN GUARDRAIL SECTIONS MAY EXCEED 4:1.
 7. ROADWAY CROSS SLOPE SHALL VARY TO MEET EDGE OF ROUNDABOUT AS FOLLOWS: (TBD)
- STA 13+00 TO 13+50 (LT & RT): -2.0% TO -1.0%
STA 15+00 TO 15+50 (LT): -0.5% TO -2.0%
STA 15+00 TO 15+50 (RT): -0.7% TO -2.0%

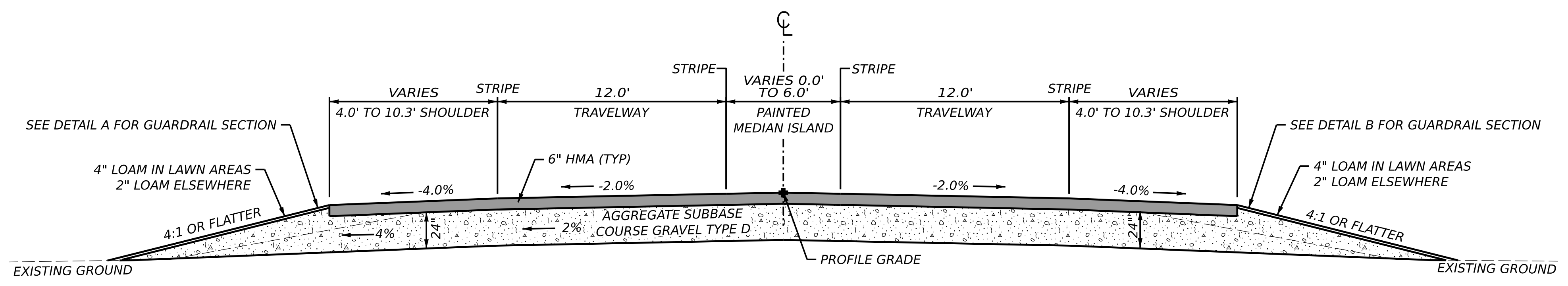

FULL DEPTH RECONSTRUCTION

STA. 10+00 TO STA. 11+42
STA. 17+68 TO STA. 18+50

SHOULDER	LEFT TRAVELWAY	RIGHT TRAVELWAY	RIGHT SHOULDER
24" A.S.C.G. = 7.4 CY/100 LF/FT OF WIDTH	24" A.S.C.G. = 88.9 CY/100 LF	24" A.S.C.G. = 88.9 CY/100 LF	24" A.S.C.G. = 7.4 CY/100 LF/FT OF WIDTH
STATION TO STATION	STATION TO STATION	STATION TO STATION	STATION TO STATION
10+00 (8.7') TO 12+78 (2.0') 17+16 (2.0') TO 18+50 (10.2')	10+00 TO 11+42 (12.0') 17+68 TO 18+50 (12.0')	10+00 TO 11+42 (12.0') 17+68 TO 18+50 (12.0')	10+00 (9.2') TO 11+42 (2.0') 15+87 (2.0') TO 18+50 (8.6')

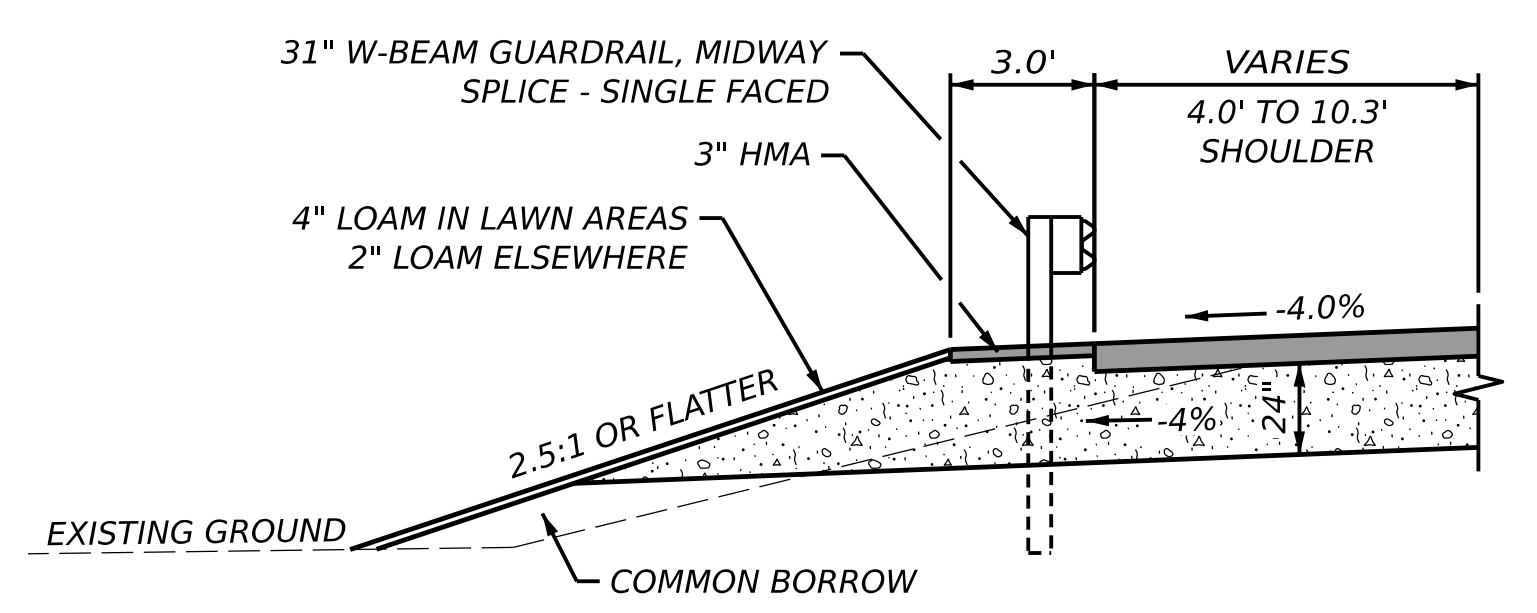

DETAIL B - GUARDRAIL SECTION LT

STA. 10+00 TO STA. 11+75

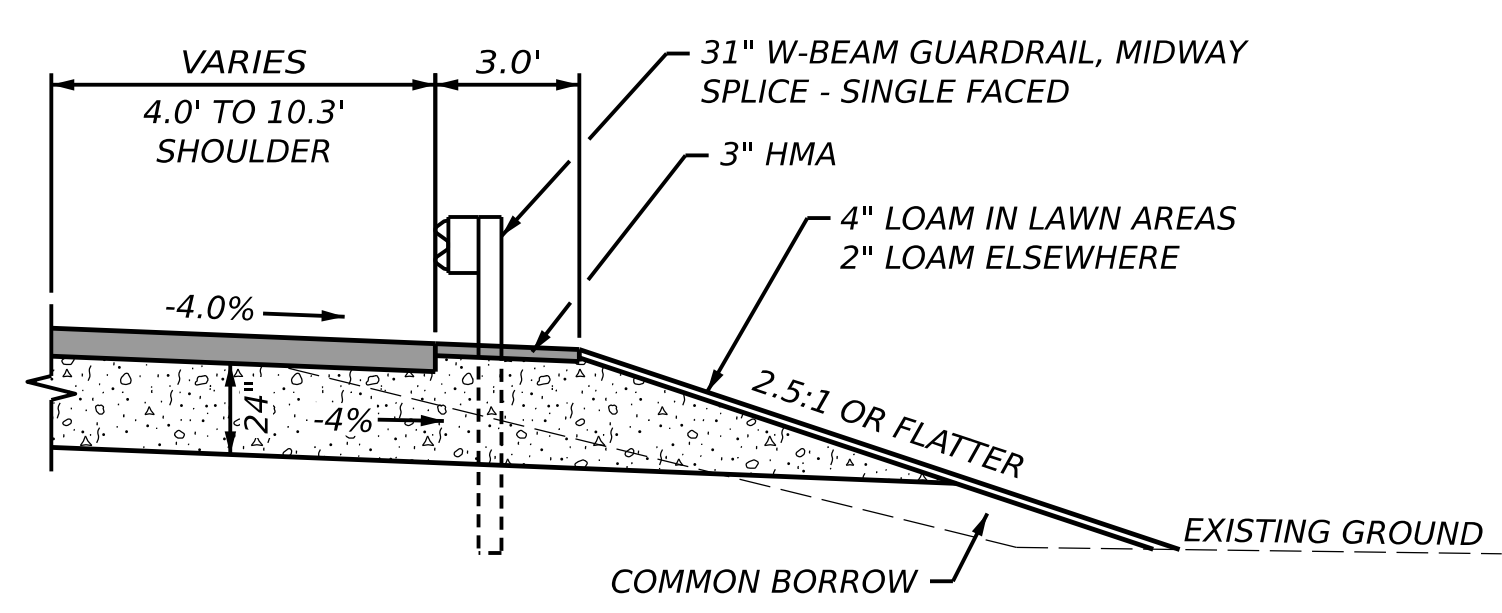

DETAIL B - GUARDRAIL SECTION RT

STA. 10+00 TO STA. 10+50
STA. 17+25 TO STA. 18+50

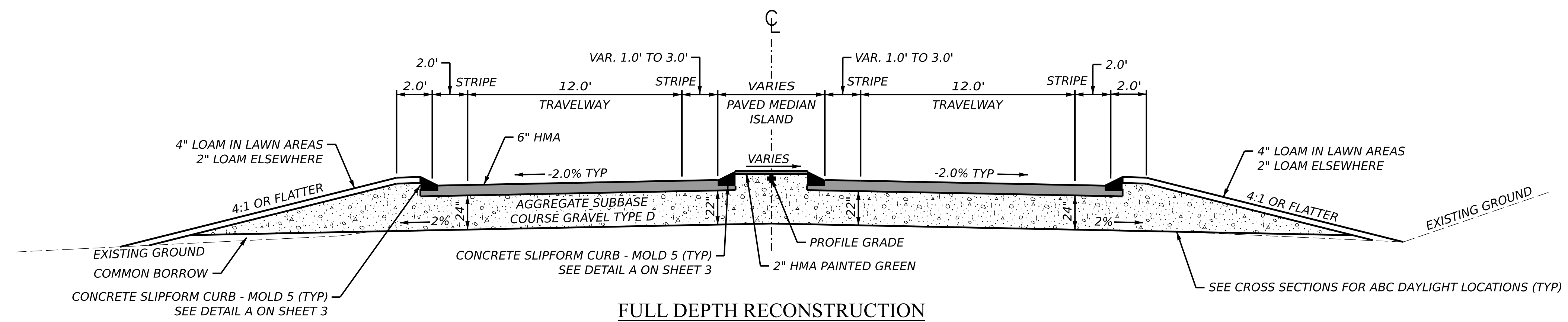

FULL DEPTH RECONSTRUCTION

STA. 12+42 TO STA. 14+48
STA. 16+00 TO STA. 18+68

SHOULDER	LEFT TRAVELWAY	RIGHT TRAVELWAY	RIGHT SHOULDER
24" A.S.C.G. = 14.8 CY/100 LF	24" A.S.C.G. = 88.9 CY/100 LF	24" A.S.C.G. = 88.9 CY/100 LF	24" A.S.C.G. = 14.8 CY/100 LF
STATION TO STATION	STATION TO STATION	STATION TO STATION	STATION TO STATION
12+78 TO 13+48 (2.0') 15+00 TO 17+16 (2.0')	11+42 TO 13+48 (12.0') 15+00 TO 17+68 (12.0')	11+42 TO 13+48 (12.0') 15+00 TO 17+68 (12.0')	11+42 TO 13+48 (2.0') 15+00 TO 17+16 (2.0')

CURB TYPE (SHEET)	
	: CONCRETE SLIPFORM CURB - MOLD 4
	: CONCRETE SLIPFORM CURB - MOLD 5
	: CURB TYPE 5 - TRUCK APRON
STATIONING	
CONCRETE SLIPFORM CURB - MOLD 4	
STA. 30+00 LT TO STA. 33+33 LT	
CONCRETE SLIPFORM CURB - MOLD 5	
STA. 11+42 RT TO STA. 22+32 LT	
STA. 12+78 LT TO STA. 25+13 LT	
STA. 15+87 RT TO STA. 21+66 RT	
STA. 17+16 LT TO STA. 25+08 RT	
CURB TYPE 5 - TRUCK APRON	
STA. 30+00 TO STA. 33+33	

PROJ. MANAGER	DATE
CHECKED-REVIEWED	BY
DESIGN-DET. FILED	
DESIGN-DET. FILED	
REVISIONS 1	
REVISIONS 2	
REVISIONS 3	
REVISIONS 4	
FIELD CHANGES	

NOTES:

1. THE PAVEMENT, BASE AND SUBBASE DEPTHS AS SHOWN ON THE PLANS ARE INTENDED TO BE NOMINAL.
2. CROWNS FOR ALL COURSES OF SUBBASE AND PAVEMENT SHALL BE STRAIGHT.
3. THE GRAVEL QUANTITY CALCULATION IS BASED ON A 4" LOAM DEPTH. THE ACTUAL DEPTH MAY VARY. SEE THE GENERAL NOTES.
4. THE ALGEBRAIC DIFFERENCE BETWEEN THE SHOULDER AND TRAVEWAY CROSS SLOPES "ROLLOVER" SHALL NOT EXCEED 8%.
5. THE STATIONING SHOWN UNDER EACH TYPICAL IS APPROXIMATE.
6. AGGREGATE SUBBASE COURSE GRAVEL TYPE D VARIES FROM 0" TO 24" FROM THE LIMITS OF WORK TO THE BEGIN/END OF PROJECT.
7. GUARDRAIL SECTIONS ARE NOT SHOWN. REFER TO PLANS AND CROSS SECTIONS FOR GUARDRAIL. SLOPES IN GUARDRAIL SECTIONS MAY EXCEED 4:1.
7. ROADWAY CROSS SLOPE SHALL VARY TO MEET EDGE OF ROUNDABOUT AS FOLLOWS:

STA 22+00 TO STA 22+75 (LT): -2.0% TO +0.7%
STA 22+50 TO STA 22+75 (RT): -2.0% TO -1.5%
STA 24+25 TO STA 24+90 (LT): +0.7% TO -2.0%

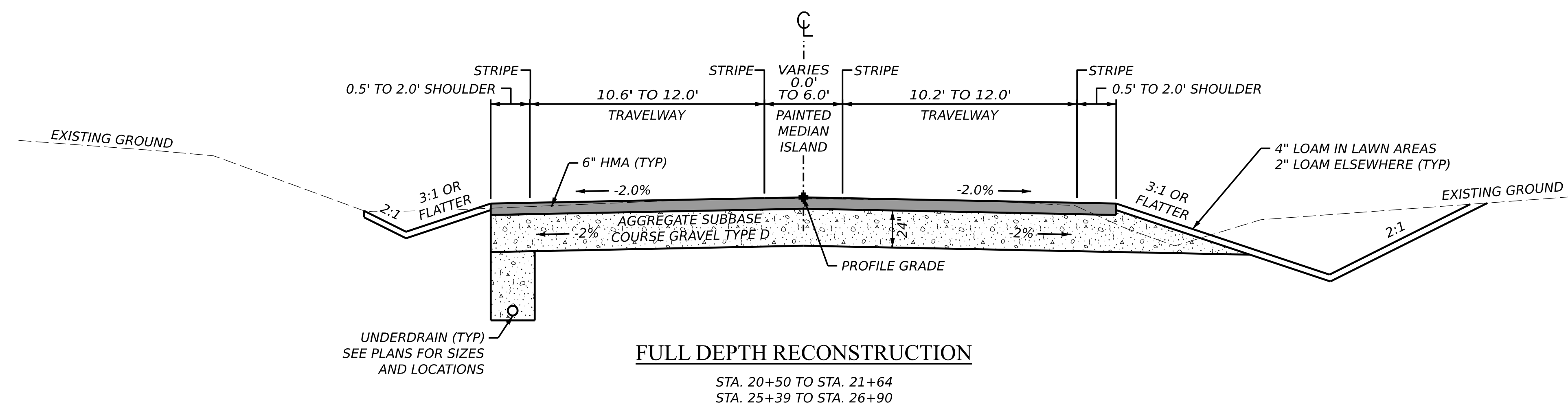

SHOULDER	LEFT TRAVELWAY	RIGHT TRAVELWAY	RIGHT SHOULDER
24" A.S.C.G.=7.4 CY/100 LF/FT OF WIDTH	24" A.S.C.G.=7.4 CY/100 LF/FT OF WIDTH	24" A.S.C.G.=7.4 CY/100 LF/FT OF WIDTH	24" A.S.C.G.=7.4 CY/100 LF/FT OF WIDTH
STATION TO STATION	STATION TO STATION	STATION TO STATION	STATION TO STATION
20+50 (0.5') TO 22+32 (2.0') 25+13 (2.0') TO 26+90 (1.0')	20+50 (11.5') TO 21+64 (12.0') 25+39 (12.0') TO 26+90 (10.6')	20+50 (10.8') TO 21+64 (12.0') 25+39 (12.0') TO 26+90 (10.2')	20+50 (0.5') TO 22+32 (2.0') 25+08 (2.0') TO 26+90 (1.0')

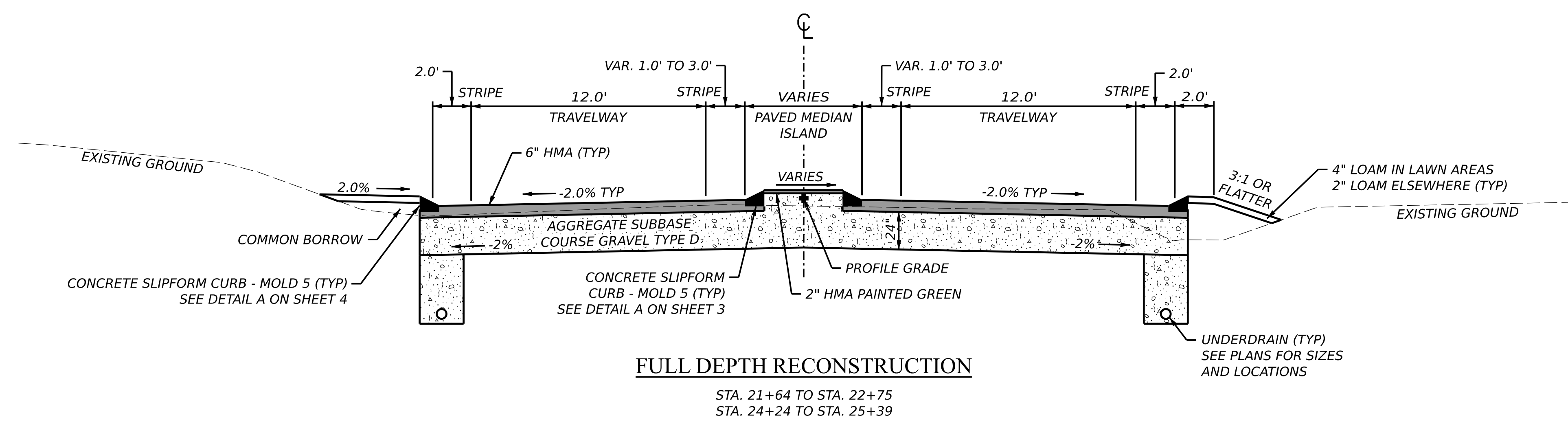

SHOULDER	LEFT TRAVELWAY	RIGHT TRAVELWAY	RIGHT SHOULDER
24" A.S.C.G.=7.4 CY/100 LF/FT OF WIDTH	24" A.S.C.G. = 88.9 CY/100 LF	24" A.S.C.G. = 88.9 CY/100 LF	24" A.S.C.G.=7.4 CY/100 LF/FT OF WIDTH
STATION TO STATION	STATION TO STATION	STATION TO STATION	STATION TO STATION
22+32 TO 22+75 (2.0') 24+24 TO 25+13 (2.0')	21+64 TO 22+75 (12.0') 24+24 TO 25+39 (12.0')	21+64 TO 22+75 (12.0') 24+24 TO 25+39 (12.0')	21+66 TO 22+75 (2.0') 24+24 TO 25+08 (2.0')

CURB TYPE (SHEET)	
	: CONCRETE SLIPFORM CURB - MOLD 4
	: CONCRETE SLIPFORM CURB - MOLD 5
	: CURB TYPE 5 - TRUCK APRON
STATIONING	
SEE SHEET 2	

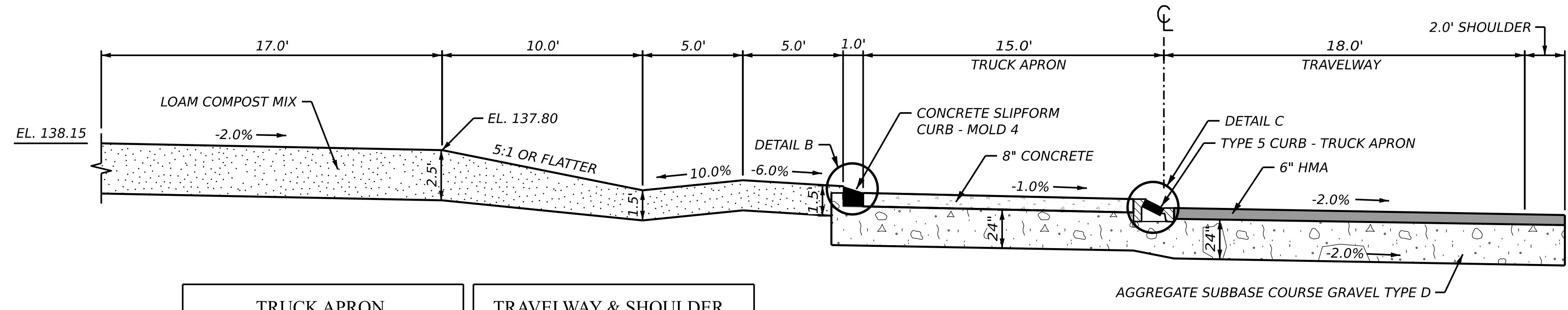

TRUCK APRON 24" A.S.C.G. = 111.1 CY/100 LF	TRAVELWAY & SHOULDER 24" A.S.C.G. = 148.1 CY/100 LF
STATION TO STATION 30+00 TO 343+33	STATION TO STATION 40+00 TO 43+33

ROUNDABOUT
STA. 30+00 TO STA. 33+33
SCALE: 1/4"=1'

- NOTES:
1. THE PAVEMENT, BASE AND SUBBASE DEPTHS AS SHOWN ON THE PLANS ARE INTENDED TO BE NOMINAL.
 2. CROWNS FOR BOTH NORMAL AND SUPERELEVATION SECTIONS FOR ALL COURSES OF SUBBASE AND PAVEMENT SHALL BE STRAIGHT.
 3. THE GRAVEL QUANTITY CALCULATION IS BASED ON A 4" LOAM DEPTH. THE ACTUAL DEPTH MAY VARY. SEE THE GENERAL NOTES.
 4. THE ALGEBRAIC DIFFERENCE BETWEEN THE SHOULDER AND TRAVELWAY CROSS SLOPES "ROLLOVER" SHALL NOT EXCEED 8%.
 5. THE STATIONING SHOWN UNDER EACH TYPICAL IS APPROXIMATE.
 6. PAVEMENT STRUCTURE IS ESTIMATED AND WILL BE UPDATED ONCE PAVEMENT DESIGN HAS BEEN COMPLETED.

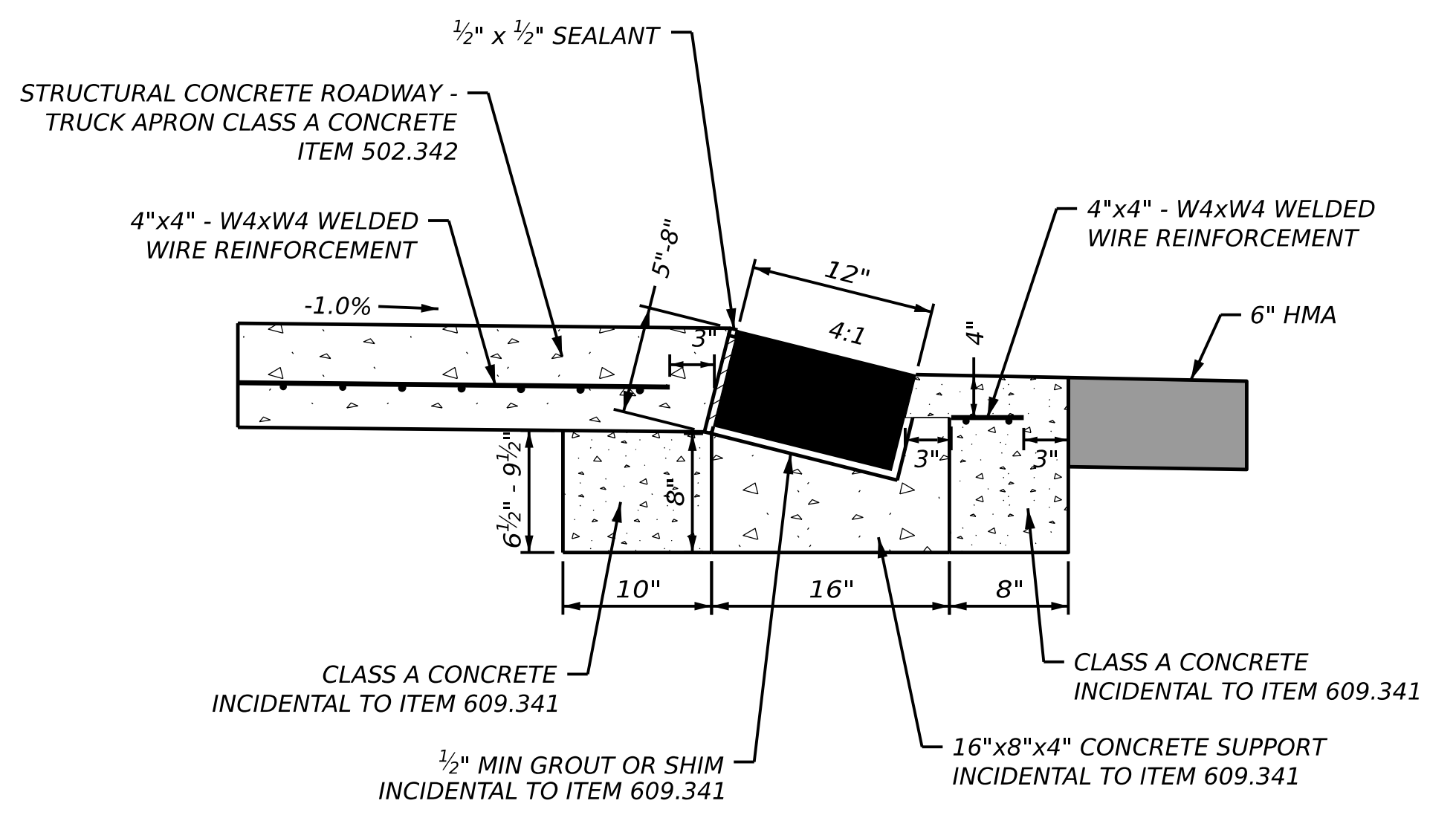
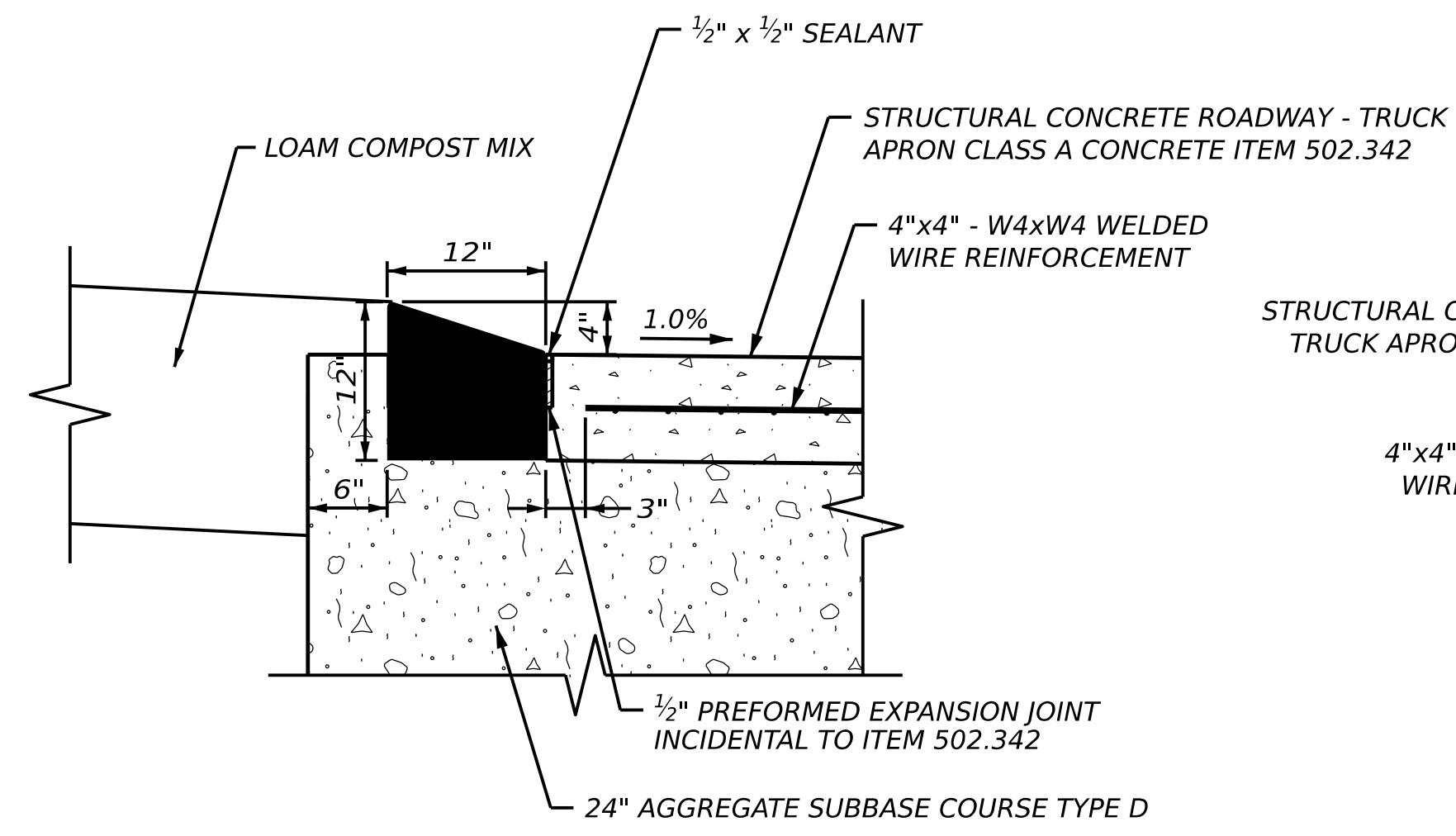
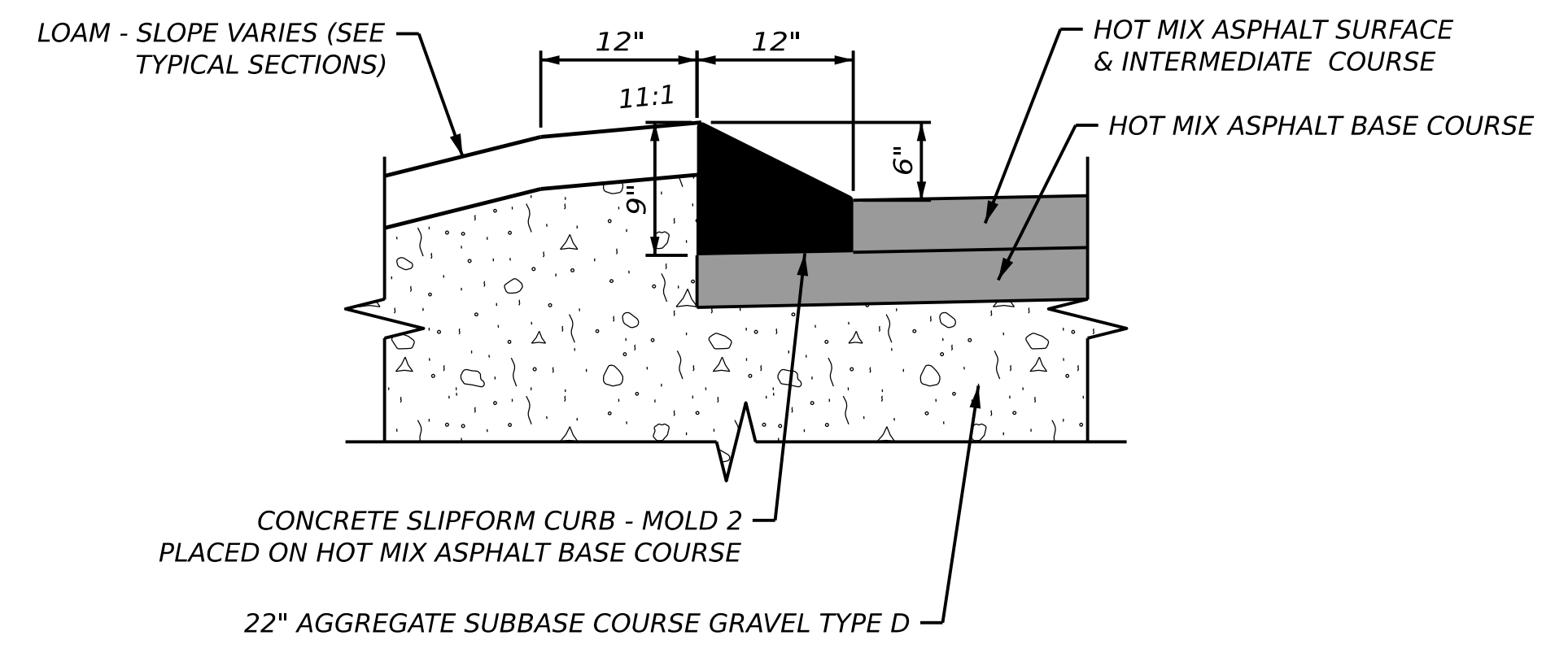

CURB TYPE (SHEET)	
■	: CONCRETE SLIPFORM CURB - MOLD 4
■	: CONCRETE SLIPFORM CURB - MOLD 5
■	: CURB TYPE 5 - TRUCK APRON
STATIONING	
SEE SHEET 2	

PROJ. MANAGER	DATE
CHECKED/REVIEWED	SIGNATURE
DESIGN/DETAIL 02	P.E. NUMBER
DESIGN/DETAIL 03	DATE
REVISIONS 1	
REVISIONS 2	
REVISIONS 3	
REVISIONS 4	
FIELD CHANGES	

WARREN	ROUTE 90 AT WESTERN RD
TYPICAL SECTIONS	

WARREN	ROUTE 90 AT WESTERN RD
TYPICAL SECTIONS	

ESTIMATED QUANTITIES			
ITEM NO.	DESCRIPTION	QUANTITY	UNIT
201.23	REMOVING SINGLE TREE TOP ONLY	1	EA
201.24	REMOVING STUMP	1	EA
203.20	COMMON EXCAVATION	3,600	CY
203.21	ROCK EXCAVATION	180	CY
304.10	AGGREGATE SUBBASE COURSE - GRAVEL	5,800	CY
403.2081	HOT MIX ASPHALT, 12.5 MM NOMINAL MAXIMUM SIZE (POLYMER MODIFIED)	500	T
403.209	HOT MIX ASPHALT, 9.5 MM NOMINAL MAXIMUM SIZE (SIDEWALKS, DRIVES, ISLANDS & INCIDENTALS)	130	T
403.213	HOT MIX ASPHALT, 12.5 MM NOMINAL MAXIMUM SIZE (BASE AND INTERMEDIATE BASE COURSE)	970	T
403.2131	HOT MIX ASPHALT, 12.5 MM NOMINAL MAXIMUM SIZE (BASE AND INTERMEDIATE BASE COURSE POLYMER MODIFIED)	500	T
409.15	BITUMINOUS TACK COAT, APPLIED	710	GAL
502.341	STRUCTURAL CONCRETE ROADWAY MEDIAN	3	CY
502.342	STRUCTURAL CONCRETE ROADWAY TRUCK APRON	33	CY
603.175	18" REINFORCED CONCRETE PIPE CLASS III	235	LF
603.179	18" CULVERT PIPE OPTION III	24	LF
603.55	CONCRETE PIPE TIES	6	EA
604.092	CATCH BASIN TYPE B1-C	11	EA
605.09	6 INCH UNDERDRAIN TYPE B	650	LF
605.11	12 INCH UNDERDRAIN TYPE C	98	LF
605.13	18 INCH UNDERDRAIN TYPE C	230	LF
606.1301	31" W-BEAM GUARDRAIL, MIDWAY SPLICE - SINGLE FACED	350	LF
606.1303	31" W-BEAM GUARDRAIL, MIDWAY SPLICE, 15' RADIUS AND LESS	25	LF
606.1305	31" W-BEAM GUARDRAIL, MIDWAY SPLICE FLARED TERMINAL	2	EA
606.353	REFLECTORIZED FLEXIBLE GUARDRAIL MARKER	3	EA
606.356	UNDERDRAIN DELINEATOR POST	9	EA
609.21	CONCRETE SLIPFORM CURB - TYPE 2	3,000	LF
609.219	CONCRETE SLIPFORM TERMINAL END TYPE 2	36	LF
609.341	CURB TYPE 5 - TRUCK APRON	335	LF
610.08	PLAIN RIPRAP	21	CY
613.319	EROSION CONTROL BLANKET	660	SY
615.07	LOAM	345	CY
615.081	COMPOST BLANKET	300	CY
615.10	DIRTY BORROW	50	CY
618.13	SEEDING METHOD NUMBER 1	22	UN
618.14	SEEDING METHOD NUMBER 2	14	UN
619.12	MULCH	36	UN
619.13	BARK MULCH	10	CY
620.58	EROSION CONTROL GEOTEXTILE	41	SY
621.031	EVERGREEN TREE 4' - 5' GR. A B&B	5	EA
621.037	EVERGREEN TREE 5' - 6' GR. A B&B	5	EA
621.043	EVERGREEN TREE 6' - 8' GR. A B&B	3	EA
621.046	EVERGREEN TREE 8' - 10' GR. A B&B	1	EA
621.101	PLUGS/STARTER PLANTS TYP 2" CONT. MIN 6" PLANTS	1,250	EA
621.396	EVERGREEN SHRUB 18" - 24" GR. B CONT.	60	EA
621.402	EVERGREEN SHRUB 2 - 2½' GR. B CONT.	30	EA
621.408	EVERGREEN SHRUB 2 ½' - 3' GR. B CONT.	12	EA
621.54	DECIDUOUS SHRUB 18- 24" GR. A CONT.	80	EA
621.546	DECIDUOUS SHRUB 2' - 3' GR. A B&B	90	EA
621.552	DECIDUOUS SHRUB 3' - 4' GR. A B&B	20	EA
621.558	DECIDUOUS 4' - 5' GR. A B&B HEAVY SPEC.	8	EA
621.71	HERBACEOUS PERENNIALS GR. A 1 GAL. CONT./PATCHES	650	EA
621.80	ESTABLISHMENT PERIOD	1	LS
626.11	PRECAST CONCRETE JUNCTION BOX	12	EA
626.22	NON-METALLIC CONDUIT	1,190	LF
626.251	NON-METALLIC CONDUIT UNDER PAVEMENT	380	LF
626.43	30-INCH DIAMETER FOUNDATION	80	LF
627.733	4" WHITE OR YELLOW PAINTED PAVEMENT MARKING LINE	5,400	LF
627.75	WHITE OR YELLOW PAVEMENT & CURB MARKING	80	LF
627.78	TEMPORARY 4" PAINT PAVEMENT MARKING LINE, WHITE OR YELLOW	5,400	LF
629.05	HAND LABOR, STRAIGHT TIME	20	HR
631.12	ALL PURPOSE EXCAVATOR (INCLUDING OPERATOR)	10	HR
631.133	SKID STEER (INCLUDING OPERATOR)	10	HR
631.14	GRADER (INCLUDING OPERATOR)	10	HR
631.172	TRUCK-LARGE (INCLUDING OPERATOR)	20	HR
631.18	CHAIN SAW RENTAL (INCLUDING OPERATOR)	10	HR
631.20	STUMP CHIPPER RENTAL (INCLUDING OPERATOR)	10	HR
631.32	CULVERT CLEANER (INCLUDING OPERATORS)	20	HR
634.160	HIGHWAY LIGHTING	1	LS
634.2042	LED LUMINAIRES	10	EA
634.210	CONVENTIONAL LIGHT STANDARD	10	EA
634.25	SERVICE POLE COMPLETE WITH CABINET AND CONTROLLER	1	EA
639.19	FIELD OFFICE TYPE B	1	EA
645.106	DEMOUNT REGULATORY, WARNING, CONFIRMATION AND ROUTE MARKER ASSEMBLY SIGN	9	EA
645.1061	RELOCATE EXISTING SIGN ASSEMBLY AND POST	3	EA
645.108	DEMOUNT POLE	7	EA
645.161	BREAKAWAY DEVICE SINGLE POLE	15	EA
645.292	REGULATORY, WARNING, CONFIRMATION AND ROUTE MARKER ASSEMBLY SIGNS TYPE II	255	SF
652.312	TYPE III BARRICADE	20	EA
652.33	DRUM	25	EA
652.34	CONE	60	EA
652.35	CONSTRUCTION SIGNS	780	SF
652.36	MAINTENANCE OF TRAFFIC CONTROL DEVICES	180	CD
652.38	FLAGGER	1,160	HR
652.41	PORTABLE CHANGEABLE MESSAGE SIGN	12	EA
656.75	TEMPORARY SOIL EROSION AND WATER POLLUTION CONTROL	1	LS
658.20	ACRYLIC LATEX FINISH, GREEN	550	SY
659.10	MOBILIZATION	1	LS

EARTHWORK SUMMARY

COMMON EXCAVATION FOR ESTIMATE

COMMON EXCAVATION (FROM MODEL OR PLANS)	3040	
GRUBBING IN FILL		TBD
LOAM SALVAGE IN FILL		
UNDERCUT		
MUCK EXCAVATION		
PEAT EXCAVATION		
CULVERT INLET AND OUTLET DITCHES	21	
PAVEMENT SALVAGE IN FILL	495	
TOTAL COMMON EXCAVATION	3566	

FILL FOR BORROW CALCULATIONS

COMMON FILL (FROM MODEL OR PLANS)	860	
GRUBBING IN FILL		TBD
LOAM SALVAGE IN FILL		
UNDERCUT	0	
MUCK EXCAVATION		
PEAT EXCAVATION		
PAVEMENT SALVAGE IN FILL	495	
RECYCLED PAVEMENT REMOVAL IN FILL		
TOTAL FILL	1355	

ROCK EXCAVATION FOR ESTIMATE

ROCK EXCAVATION (FROM CROSS SECTIONS)	180	Assume 5% of excavation
ROCK EXCAVATION (BOULDERS)		
TOTAL ROCK EXCAVATION	180	

AVAILABLE COMMON EXCAVATION FOR BORROW CALCULATIONS

ALL DEDUCTIONS		
GRUBBING IN CUT		0
GRUBBING IN FILL		0
LOAM SALVAGE IN CUT		
LOAM SALVAGE IN FILL		
UNDERCUT		0
MUCK EXCAVATION		
PEAT EXCAVATION		
PAVEMENT SALVAGE (CUT & FILL)		990
TOTAL DEDUCTIONS		990

TOTAL AVAILABLE COMMON EXCAVATION (-) TOTAL DEDUCTIONS	2566	
TOTAL AVAILABLE STRUCTURAL EXCAVATION (UNDERDRAIN ONLY)		
RRIPRAP EXCAVATION		
TOTAL AVAILABLE NON-ROCK EXCAVATION	2566	

COMPUTATION OF WASTE STORAGE & WASTE MATERIAL

TOTAL AVAILABLE WASTE STORAGE AREA (FROM CROSS SECTIONS)		
GRUBBING IN CUT		0
GRUBBING IN FILL		0
UNDERCUT		0
MUCK EXCAVATION		
PEAT EXCAVATION		
TOTAL WASTE MATERIAL		0

TOTAL WASTE MATERIAL TO BE UTILIZED*		
TOTAL WASTE MATERIAL TO BE WASTED		0

COMPUTATION FOR GRANULAR BORROW FOR ESTIMATE

GRANULAR BORROW TO REPLACE MUCK		
GRANULAR BORROW TO REPLACE PEAT		
GRANULAR BORROW IN LOW WET AREAS		
GRANULAR BORROW FOR EMBANKMENT CONSTRUCTION NEAR BOX CULVERTS		
GRANULAR BORROW TO MAINTAIN TRAFFIC		
GRANULAR BORROW FOR UNDERCUTTING		
GRANULAR BORROW FOR CULVERT BEDDING		
TOTAL GRANULAR BORROW		0

COMPUTATION FOR SURPLUS MATERIAL OR COMMON BORROW FOR ESTIMATE

TOTAL AVAILABLE NON-ROCK EXCAVATION	2566 x 0.90	=	2310
TOTAL AVAILABLE ROCK EXCAVATION	180 x 1.30	=	235
TOTAL AVAILABLE STRUCTURAL ROCK EXCAVATION	x 1.30	=	0
TOTAL WASTE MATERIAL TO BE UTILIZED	0 x 0.90	=	0

TOTAL AVAILABLE EXCAVATION	2545	
----------------------------	------	--

BORROW NEEDED = TOTAL FILL (-) TOTAL AVAILABLE EXCAVATION	0	
IF NO BORROW IS NEEDED, SURPLUS MATERIAL = AVAILABLE EXCAVATION (-) TOTAL FILL (+) TOTAL WASTE MATERIAL TO BE WASTED	1190	

SURPLUS MATERIAL	1190 CY	
------------------	---------	--

GRANULAR BORROW IN LOW WET AREAS		
GRANULAR BORROW TO MAINTAIN TRAFFIC		
BORROW NEEDED (-) REQUIRED GRANULAR BORROW WITHIN FILL	0	

COMMON BORROW	0 CY	
---------------	------	--

STATE OF MAINE
DEPARTMENT OF TRANSPORTATION

BY	D-TE	SIGNATURE	P.E. NUMBER	DATE

WARREN
ROUTE 90 AT WESTERN RD
ESTIMATED QUANTITIES

SHEET NUMBER

5

OF 64

WIN
27036.00
HIGHWAY PLANS

STATION	CULVERT PIPE												CATCH BASIN				PIPE ARCH			MH	UNDERDRAIN				ELBOWS, TEES, WYES AND INLET GRATE UNITS	REMARKS
	RCP			CMP			OPTION III														TYPE B		TYPE C			
	OPTION I			SMOOTHLINED		CORRUGATED		A1-C	B1-C	E	F	SPAN	RISE	LENGTH	GAGE OR WALL THICKNESS	TYPE B LENGTH	OUTLET LENGTH	SMOOTHLINED		CORRUGATED		DESCRIPTIONS				
	SIZE	LENGTH	CLASS	SIZE	LENGTH	SIZE	LENGTH											SIZE	LENGTH	SIZE	LENGTH		SIZE	LENGTH	SIZE	
CATCH BASINS																										
CB-1 - STA 12+56, 18.1' RT																										
CB-2 - STA 12+92, 21.9' RT																										
CB-3 - STA 13+22, 30.3' RT																										
CB-4 - STA 12+94, 20.0' LT																										
CB-5 - STA 22+57, 34.3' LT																										
CB-6 - STA 22+33, 26.6' LT																										
CB-7 - STA 22+33, 20.6' RT																										
CB-8 - STA 24+67, 22.8' LT																										
CB-9 - STA 24+92, 18.8' LT																										
CB-10 - STA 24+92, 19.2' RT																										
CB-11 - STA 14+55, 0.0' LT																										
ROADWAY CULVERTS																										
CB-2 TO CB-4																										
15"	35'	III																								
CB-4 TO STA 12+91, 42.1' LT																										
15"	22'	III																								
CB-6 TO CB-7																										
18"	42'	III																								
CB-9 TO CB-10																										
18"	31'	III																								
CB-10 TO STA 24+92, 38.5' RT																										
18"	18'	III																								
CB-11 TO STA 15+20, 53.5' LT																										
18"	82'	III																								
DRIVEWAY CULVERTS																										
STA 26+11 LT TO STA 26+35 LT																										
								18"	24'																	
UNDERDRAIN																										
CB-1 TO CB-2																										
																		12"	31'							
CB-3 TO CB-2																										
																		12"	27'							
STA 20+50, 11.5' LT TO CB-6																										
																		6"	181'							
STA 20+50, 10.8' RT TO STA CB-7																										
																		6"	181'							
STA 22+77, 42.0' LT TO STA CB-5																										
																		6"	20'							
CB-5 TO CB-6																										
																		12"	20'							
CB-7 TO STA 15+90, 32.8' RT																										
																		18"	230'							
STA 24+02, 52.9' LT TO CB-8																										
																		6"	70'							
CB-8 TO CB-9																										
																		12"	20'							
STA 26+90, 10.2' LT TO CB-9																										
																		6"	194'							

PROJ. M-N-GER	BY	D-TE	SIGNATURE	P.E. NUMBER	DATE
DESIGN-DET-LED					
CHECKED-REVIEWED					
DESIGN-DET-LED					
DESIGN-DET-LED					
REVISIONS 1					
REVISIONS 2					
REVISIONS 3					
REVISIONS 4					
FIELD CHANGES					

WARREN
ROUTE 90 AT WESTERN RD
CONSTRUCTION NOTES

GENERAL NOTES

- 1. CLEARING LIMITS SHALL BE 10 FEET BEYOND AND PARALLEL TO THE CONSTRUCTION SLOPE LINES OR AS SHOWN ON THE PLANS UNLESS OTHERWISE AUTHORIZED BY THE RESIDENT.
- 2. ALL CLEARING SHALL BE CONSIDERED INCIDENTAL TO THE CONTRACT AND NO SEPARATE PAYMENT WILL BE MADE. THE ACTUAL LINES FOR CLEARING SHALL BE ESTABLISHED IN THE FIELD BY THE CONTRACTOR AS INDICATED ON THE PLANS AND APPROVED BY THE RESIDENT.
- 3. THE CLEARING AND SELECTIVE CLEARING AND THINNING LINES SHOWN ON THE PLANS ARE FOR ESTIMATING PURPOSES ONLY. THE ACTUAL LINES FOR CLEARING AND THINNING SHALL BE ESTABLISHED IN THE FIELD BY THE CONTRACTOR AND APPROVED BY THE RESIDENT.
- 4. STUMP REMOVAL HAS BEEN ESTIMATED UNDER STANDARD SPECIFICATIONS ITEM 201.24, REMOVE STUMP. HOWEVER, WHERE DIRECTED BY THE RESIDENT, STANDARD SPECIFICATIONS ITEM 631.20, STUMP CHIPPER RENTAL (INCLUDING OPERATOR) MAY BE USED TO REMOVE STUMPS.
- 5. GRUBBING IN FILL AREAS HAS BEEN SHOWN ON THE CROSS SECTIONS AND THE QUANTITIES NOTED. THESE LIMITS ARE APPROXIMATE AND HAVE BEEN USED FOR ESTIMATING PURPOSES ONLY. ACTUAL GRUBBING LIMITS MAY VARY BASED ON FIELD CONDITIONS AS DIRECTED BY THE RESIDENT.
- 6. ALL INSLOPE AND DITCHES IN CUT AREAS SHALL BE GRADED AS SHOWN ON THE TYPICALS OR FLATTER, OR AS DIRECTED BY THE RESIDENT.
- 7. THE CONTRACTOR SHALL PLAN AND CONDUCT WORK SO THAT UPON COMPLETION OF THE PROJECT THERE IS NO DROP-OFF FROM THE EDGE OF THE SHOULDER PAVEMENT.
- 8. DRIVEWAY FILL SIDE SLOPES SHALL BE THE SAME AS THE FILL SIDE SLOPES WITHOUT GUARDRAIL UNLESS OTHERWISE NOTED ON THE PLANS.
- 9. ALL WASTE MATERIAL NOT USED ON THE PROJECT SHALL BE DISPOSED OF OFF THE PROJECT IN ACCEPTABLE WASTE AREAS REVIEWED BY THE RESIDENT. GRADING, SEEDING AND MULCHING OF WASTE AREAS SHALL BE CONSIDERED INCIDENTAL.
- 10. REQUIRED DITCH PROTECTION SHOWN ON THE PLANS OR IN THE CONSTRUCTION NOTES IS FOR ESTIMATING PURPOSES ONLY. THE ACTUAL TYPE AND LOCATION OF DITCH PROTECTION MAY BE ALTERED BY THE RESIDENT.
- 11. GRANULAR BORROW USED TO BACKFILL MUCK EXCAVATION OR IN LOW WET AREAS TO 1 FOOT ABOVE WATER LEVEL OR OLD GROUND SHALL MEET REQUIREMENTS FOR GRANULAR BORROW MATERIAL FOR UNDERWATER BACKFILL AS SPECIFIED IN STANDARD SPECIFICATIONS ITEM 703.19, GRANULAR BORROW.
- 12. EXISTING INSLOPES IN PROPOSED FILL AREAS SHALL BE BENCHED BY EXCAVATING STEPS OF SUFFICIENT WIDTH TO PERMIT PLACING AND COMPACTING THE FILL MATERIAL ALONG WITH THE MATERIAL REMOVED.
- 13. COMMERCIAL PAVED ENTRANCES SHALL BE CONSTRUCTED WITH 3 INCHES OF HOT MIX ASPHALT AND 11 INCHES OF AGGREGATE SUBBASE COURSE GRAVEL.
- 14. GRAVEL ENTRANCES SHALL BE CONSTRUCTED WITH 14 INCHES OF AGGREGATE SUBBASE COURSE GRAVEL OR 11 INCHES OF AGGREGATE SUBBASE COURSE GRAVEL AND 3 INCHES OF UNTREATED AGGREGATE SURFACE COURSE UNLESS OTHERWISE NOTED IN THE PLANS OR DIRECTED BY THE RESIDENT.
- 15. A 3-FOOT PAVED LIP SHALL BE PLACED AT ALL UNPAVED ENTRANCES UNLESS OTHERWISE NOTED IN THE PLANS OR DIRECTED BY THE RESIDENT.
- 16. PRIOR TO SURFACE PAVING, EXISTING CULVERTS TO REMAIN SHALL BE CLEANED AS DIRECTED BY THE RESIDENT. PAYMENT WILL BE MADE UNDER STANDARD SPECIFICATIONS ITEM 631.32, CULVERT CLEANER (INCLUDING OPERATOR).
- 17. EXISTING CULVERTS AND CATCH BASINS WILL BE CLEANED AS DIRECTED BY THE RESIDENT UNDER THE APPROPRIATE PAY ITEMS.
- 18. NO EXISTING DRAINAGE SHALL BE ABANDONED, REMOVED OR PLUGGED WITHOUT PRIOR APPROVAL OF THE RESIDENT.
- 19. INLETS AND OUTLETS OF ALL CULVERTS SHALL BE RIPRAPPED UNLESS OTHERWISE NOTED ON THE PLANS OR DIRECTED BY THE RESIDENT.
- 20. FLAT TOPS FOR CATCH BASINS ARE NOT ALLOWED UNLESS NOTED ON THE PLANS OR DIRECTED BY THE RESIDENT.
- 21. ANY NECESSARY CUTTING OF EXISTING PIPES TO FIT IN AREAS OF PROPOSED CATCH BASINS WILL NOT BE PAID FOR SEPARATELY AND WILL BE CONSIDERED INCIDENTAL TO STANDARD SPECIFICATIONS SECTION 604, MANHOLES, INLETS AND CATCH BASINS.
- 22. ANY NECESSARY CUTTING OF EXISTING CATCH BASINS TO ALLOW FOR PROPOSED PIPE CONNECTIONS WILL NOT BE PAID FOR SEPARATELY AND WILL BE CONSIDERED INCIDENTAL TO STANDARD SPECIFICATIONS SECTION 603, PIPE CULVERTS AND STORM DRAINS OR STANDARD SPECIFICATIONS SECTION 605, UNDERDRAINS.
- 23. EXISTING ABANDONED WATER MAINS BROKEN BY THE CONTRACTOR DURING CONSTRUCTION SHALL HAVE THE ENDS PLUGGED WITH BRICK AND MORTAR. COST FOR ALL LABOR AND MATERIAL WILL BE CONSIDERED INCIDENTAL TO THE CONTRACT AND NO DIRECT PAYMENT WILL BE MADE.

- 24. GUARDRAIL END TREATMENTS SHALL BE INSTALLED CONCURRENTLY WITH THE PLACEMENT OF EACH SECTION OF BEAM GUARDRAIL.
- 25. ALL EXISTING GUARDRAIL REMOVED AND NOT REUSED ON THE PROJECT WILL BECOME THE PROPERTY OF THE CONTRACTOR. REMOVAL AND DISPOSAL SHALL BE CONSIDERED INCIDENTAL TO THE GUARDRAIL ITEMS.
- 26. TWO REFLECTORIZED FLEXIBLE GUARDRAIL MARKERS (STANDARD SPECIFICATIONS ITEM 606.353, REFLECTORIZED FLEXIBLE GUARDRAIL MARKER) WILL BE INSTALLED AT EACH GUARDRAIL END.
- 27. CONNECTIONS FOR PROPOSED GUARDRAIL TO EXISTING GUARDRAIL WILL BE CONSIDERED INCIDENTAL TO STANDARD SPECIFICATIONS SECTION 606, GUARDRAIL.
- 28. LOAM HAS BEEN ESTIMATED FOR DISTURBED LAWN AREAS. ACTUAL PLACEMENT OF THE LOAM SHALL BE AS NOTED ON THE PLANS OR DESIGNATED BY THE RESIDENT.
- 29. UNLESS OTHERWISE NOTED SEEDING METHOD NO. 1 SHALL BE UTILIZED ON ALL LAWNS AND DEVELOPED AREAS; SEEDING METHOD NO. 2 SHALL BE UTILIZED ON ALL OTHER AREAS.
- 30. LOAM SHALL BE PLACED TO A NOMINAL DEPTH OF 4 INCHES IN LAWN AREAS AND 2 INCHES IN ALL OTHER AREAS UNLESS OTHERWISE NOTED OR DIRECTED.
- 31. ACRYLIC LATEX COLOR FINISH GREEN (STANDARD SPECIFICATIONS ITEM 658.20, ACRYLIC LATEX COLOR FINISH) SHALL BE PLACED ON ALL PAVED ISLANDS.
- 32. WHITE PAVEMENT/CURB MARKING (STANDARD SPECIFICATIONS ITEM 627.75, WHITE OR YELLOW PAVEMENT & CURB MARKING) SHALL BE APPLIED TO ALL ISLAND TAPERED ENDS.
- 33. ANY BASE PAVEMENT NOT SURFACED BEFORE WINTER WILL REQUIRE TEMPORARY PAVEMENT MARKINGS OF PAINT, BOTH YELLOW CENTERLINE AND WHITE EDGE LINES AND WILL BE CONSIDERED PART OF STANDARD SPECIFICATIONS ITEM 627.78, TEMPORARY PAVEMENT MARKING LINE, WHITE OR YELLOW.
- 34. THE CONTRACTOR WILL BE RESPONSIBLE FOR MAINTAINING ALL EXISTING MAILBOXES TO ENSURE THAT THE MAIL WILL BE DELIVERABLE. PAYMENT FOR THIS WORK WILL BE CONSIDERED INCIDENTAL TO THE CONTRACT.
- 35. THE CONTRACTOR WILL BE RESPONSIBLE FOR MAINTAINING ALL EXISTING OPERATIONAL BUSINESS DIRECTIONAL SIGNS (OBDS) TO ENSURE THAT THEY ARE VISIBLE TO THE TRAVELING PUBLIC. PAYMENT FOR THIS WORK WILL BE CONSIDERED INCIDENTAL TO THE CONTRACT.
- 36. ANY DAMAGE TO THE SLOPES CAUSED BY THE CONTRACTOR'S EQUIPMENT, PERSONNEL, OR OPERATION SHALL BE REPAIRED TO THE SATISFACTION OF THE RESIDENT. ALL WORK, EQUIPMENT, AND MATERIALS REQUIRED TO MAKE REPAIRS SHALL BE AT THE CONTRACTOR'S EXPENSE.
- 37. GEOTECHNICAL INFORMATION FURNISHED OR REFERRED TO IN THE BID DOCUMENTS IS FOR THE USE OF THE BIDDERS. NO ASSURANCE IS GIVEN THAT THE INFORMATION OR INTERPRETATIONS WILL BE REPRESENTATIVE OF THE ACTUAL SUBSURFACE CONDITIONS THROUGHOUT THE CONSTRUCTION SITE. MAINEDOT WILL NOT BE RESPONSIBLE FOR ANY INTERPRETATIONS OR CONCLUSIONS DRAWN FROM THE GEOTECHNICAL INFORMATION. THE BORING LOGS PROVIDED IN THE BID DOCUMENTS (IF ANY) PRESENT FACTUAL AND INTERPRETIVE SUBSURFACE INFORMATION COLLECTED AT DISCRETE LOCATIONS. DATA PROVIDED MAY NOT BE REPRESENTATIVE OF THE SUBSURFACE CONDITIONS BETWEEN BORING LOCATIONS.
- 38. AREAS ON THE PROJECT REQUIRING FILL WILL COME FROM SUITABLE SITES SUCH AS EXCAVATION, DITCH AND INSLOPE OR EQUIPMENT RENTAL AREAS.
- 39. ESTIMATED QUANTITIES FOR REQUIRED STRUCTURAL EARTH EXCAVATION, DRAINAGE AND MINOR STRUCTURES ARE INFORMATIONAL ONLY AND REPRESENT THE APPROXIMATE MINIMUM QUANTITY REQUIRED TO INSTALL DRAINAGE STRUCTURES. ADDITIONAL EXCAVATION FOR THE CONTRACTOR'S CONVENIENCE OR TO COMPLY WITH BACKSLOPING REQUIREMENTS WILL NOT BE PAID FOR DIRECTLY BUT WILL BE CONSIDERED INCIDENTAL TO THE RELATED DRAINAGE ITEMS.
- 40. NO SEPARATE PAYMENT FOR SUPERINTENDENT OR FOREMAN WILL BE MADE FOR THE SUPERVISION OF EQUIPMENT AND LAYOUT OF WORK BEING PAID FOR UNDER THE EQUIPMENT RENTAL ITEMS.
- 41. UNDETERMINED LOCATIONS SHALL BE DETERMINED BY THE RESIDENT.
- 42. FINAL STRIPING FOR THE PROJECT SHALL BE DONE BY THE CONTRACTOR PER THE STRIPING LAYOUT IN THE CONTRACT DOCUMENTS OR AS PROVIDED BY THE DEPARTMENT. PAYMENT SHALL BE MADE UNDER APPROPRIATE CONTRACT ITEMS.

- 43. THE CONTRACTOR WILL PLACE APPROPRIATELY-MARKED STAKES AT THE FOLLOWING LOCATIONS ON THE PROJECT: STRIPING PATTERN CHANGES, CROSS-SLOPE CHANGES, AND EVERY 500 FEET FOR STATIONING. THE CONTRACTOR WILL PAINT EVERY FULL STATION (100 FEET) ON THE EXISTING ROADWAY AND WILL TRANSFER THE PAINTED STATIONING THROUGH ALL INTERMEDIATE LIFTS (NOT SURFACE). APPROPRIATELY-SIZED STRIPING PATTERN CHANGES WILL BE PAINTED ON SURFACE. STATIONING CONTROL MUST BE PLACED BEFORE WORK CAN COMMENCE. CROSS-SLOPE AND STRIPING CHANGE CONTROLS MUST BE PLACED BEFORE PAVING CAN COMMENCE.
- 44. ALL HMA FOR PATCHING AROUND ADJUSTED, ALTERED, OR REBUILT UTILITY STRUCTURES SHALL BE A 9.5 MM OR 12.5 MM MAINEDOT APPROVED MIX DESIGN. EXCLUDING WATER AND GAS GATE VALVES, THE CONTRACTOR SHALL SAW CUT THE EXISTING PAVEMENT FOR THE PATCH AT LEAST TWO FEET AWAY FROM THE NEAREST EDGE OF THE STRUCTURE. THE CONTRACTOR SHALL PLACE HMA IN LIFTS OF 2 INCHES OR LESS TO MATCH THE EXISTING PAVEMENT DEPTH OR A MAXIMUM OF 6 INCHES, AS DIRECTED BY THE RESIDENT, AND COMPACT THE HMA USING A MINIMUM OF A 150-POUND PLATE COMPACTOR. HMA FOR PATCHING AROUND ADJUSTED, ALTERED, OR REBUILT UTILITY STRUCTURES IS CONSIDERED INCIDENTAL TO THE RESPECTIVE PAY ITEM FOR ADJUST, ALTER, OR REBUILT UTILITY STRUCTURE.

WARREN ROUTE 90 AT WESTERN RD		STATE OF MAINE DEPARTMENT OF TRANSPORTATION	
GENERAL NOTES		WIN 27036.00 HIGHWAY PLANS	
SHEET NUMBER		7	
OF		64	

PROJ. MANAGER	DATE	BY	SIGNATURE	P.E. NUMBER	DATE
DESIGN-DETAILED					
CHECKED-REVIEWED					
DESIGN-DETAILED					
REVISIONS 1					
REVISIONS 2					
REVISIONS 3					
REVISIONS 4					
FIELD CHANGES					

DRIVES AND ENTRANCES

STATIONING	TYPE	OPENING
STA 10+74 RT	ASPHALT	55'
STA 21+55 RT	ASPHALT	25'
STA 22+08 LT	ASPHALT	53'
STA 23+46 LT	GRAVEL	16'
STA 26+23 LT	GRASS	12'

ITEM 201.23 - REMOVING SINGLE TREE TOP ONLYITEM 201.24 - REMOVING STUMP

STATIONING
21+99, 29.3' RT

ITEM 603.55 - CONCRETE PIPE TIES

STATIONING
STA 12+94, 20.0' LT TO STA 12+92, 42.1' LT
STA 14+55, 0.0' LT TO STA 15+20, 53.5' LT
STA 22+32, 20.5' RT TO STA 22+30, 30.3' RT
STA 24+92, 19.2' RT TO STA 24+92, 38.5' RT

ITEM 606.1301 - 31" W-BEAM GUARDRAIL, MIDWAY SPLICE - SINGLE FACED

STATIONING	LENGTH
STA 10+00, 20.0' LT TO STA 11+75, 20.0' LT	150'
STA 10+00, 20.0' RT TO STA 10+50, 20.0' RT	50'
STA 17+25, 21.3' RT TO STA 18+50, 21.2' RT	125'

ITEM 606.1305 - 31" W-BEAM GUARDRAIL, MIDWAY SPLICE - FLARED TERMINAL

STATIONING
STA 11+75, 20.0' LT TO STA 12+18, 22.7' LT
STA 16+83, 24.4' RT TO STA 17+25, 21.3' RT

ITEM 610.08 - PLAIN RIPRAP

CROSS CULVERTS	RIPRAP PAD INLET	RIPRAP PAD OUTLET
STA 12+92, 42.1' LT		6' X 8'
STA 15+18, 51.9' LT		6' X 20'
STA 24+92, 38.5' RT		6' X 8'
<u>DOWNSPOUTS</u>		
STA 15+90, 19.6' RT		5' X 20'
STA 17+19, 22.2' LT		5' X 12'

ITEM 609.21 - CONCRETE SLIPFORM CURB - MOLD 2

SEE GEOMETRIC SHEETS

ITEM 609.21 - CONCRETE SLIPFORM CURB - MOLD 4

SEE GEOMETRIC SHEETS

ITEM 609.21 - CONCRETE SLIPFORM CURB - MOLD 5

SEE GEOMETRIC SHEETS

ITEM 609.219 - CONCRETE SLIPFORM TERMINAL END TYPE 2

SEE GEOMETRIC SHEETS

ITEM 609.341 - CURB TYPE 5 - TRUCK APRON

SEE GEOMETRIC SHEETS

ITEM 619.319 - EROSION CONTROL BLANEKT

DITCHES	LENGTH
STA 12+25 LT TO STA 12+92 LT	9.0'W x 70'L
STA 27+90 RT TO STA 16+00 LT	9.0'W x 326'L
STA 15+90 RT TO STA 17+18 RT	9.0'W x 129'L
STA 16+80 LT TO STA 17+17 LT	9.0'W x 37'L
STA 24+92 LT TO STA 25+90 LT	9.0'W x 96'L

ITEM 620.58 - EROSION CONTROL GEOTEXTILE

CROSS CULVERTS	RIPRAP PAD INLET	RIPRAP PAD OUTLET
STA 12+92, 42.1' LT		6' X 8'
STA 15+18, 51.9' LT		6' X 20'
STA 24+92, 38.5' RT		6' X 8'
<u>DOWNSPOUTS</u>		
STA 15+90, 19.6' RT		5' X 20'
STA 17+19, 22.2' LT		5' X 12'

ITEM 621 - LANDSCAPING

SEE BID BOOK

STATE OF MAINE
DEPARTMENT OF TRANSPORTATIONWIN
27036.00
HIGHWAY PLANS

PROJ. MANAGER	BY	DATE	SIGNATURE	P.E. NUMBER	DATE
DESIGN-DETAILED					
CHECKED-REVIEWED					
DESIGN-DETAILED					
DESIGN-DETAILED					
REVISIONS 1					
REVISIONS 2					
REVISIONS 3					
REVISIONS 4					
FIELD CHANGES					

WARREN
ROUTE 90 AT WESTERN RD

CONSTRUCTION NOTES

SHEET NUMBER

8

OF 64

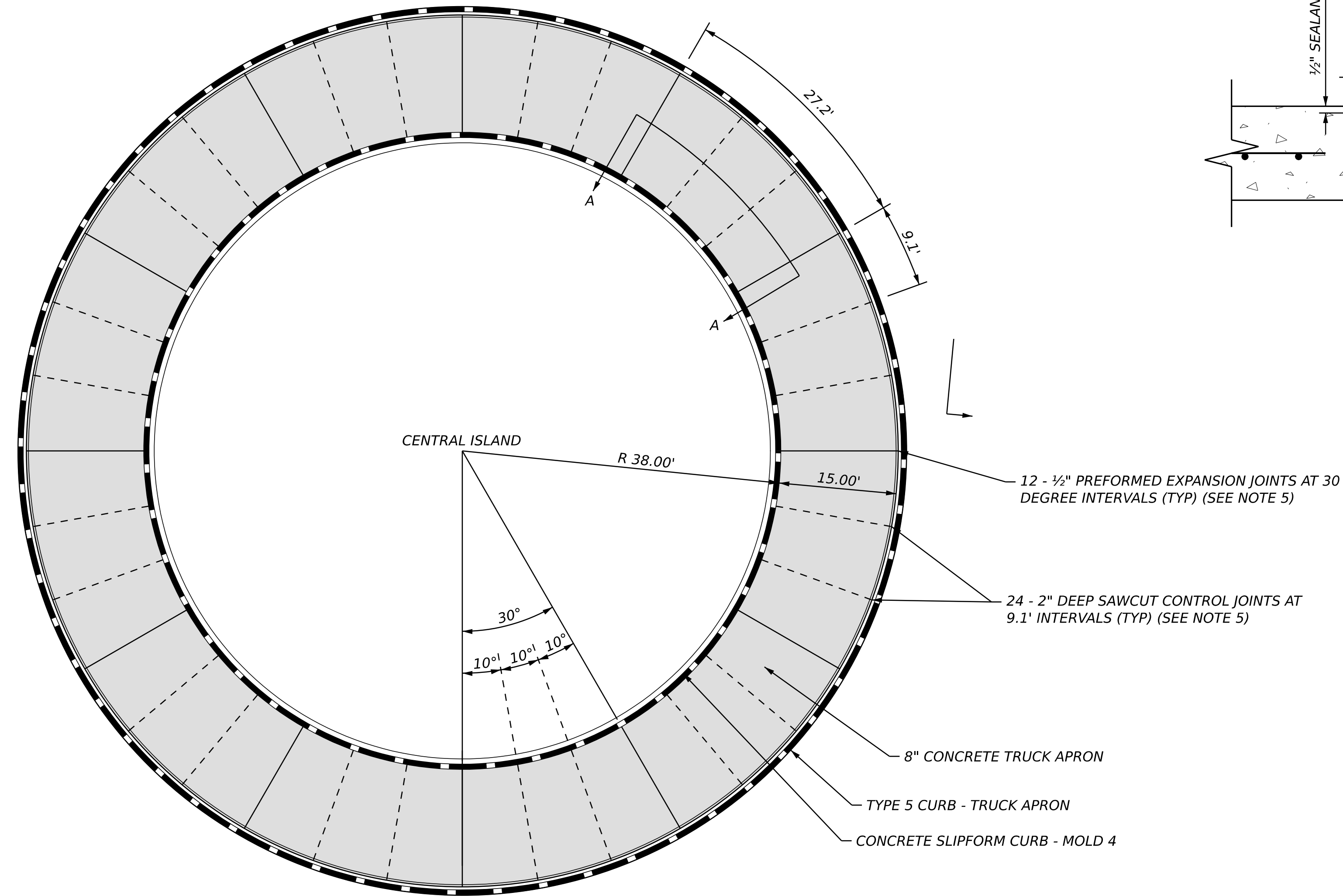

CENTRAL TRUCK APRON - EXPANSION AND CONTROL JOINT PLAN
SCALE: 1" = 10'

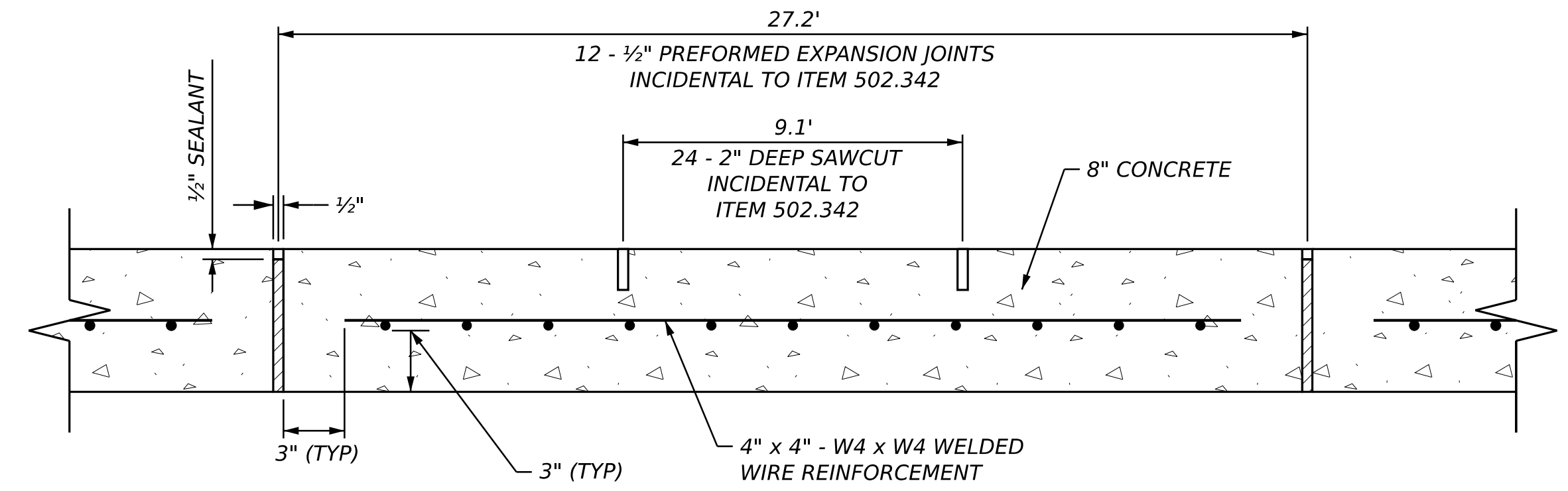

CENTRAL TRUCK APRON - EXPANSION AND CONTROL JOINT SECTION
SECTION A-A
NOT TO SCALE

NOTES

1. THE 4" x 4" W4 x W4 WELDED WIRE REINFORCEMENT SHALL BE SUPPORTED ON CHAIR. THE WELDED WIRE REINFORCEMENT AND CHAIRS SHALL BE INCIDENTAL TO ITEM 502.342.
2. CONCRETE SUPPORTS FOR TYPE 5 CURB - TRUCK APRON SHALL BE PLACED PRIOR TO CONCRETE PLACEMENT. EACH SECTION OF CURB SHALL BE GROUTED OR SHIMMED PRIOR TO PLACING CONCRETE. FULL GROUT BED MUST BE USED WHERE SHIMS ARE LESS THAN 2" IN HEIGHT. THIS SHALL BE INCIDENTAL TO ITEMS 609.341.
3. CONTRACTOR SHALL PLACE THE CONCRETE WITH CARE AND ASSURE THE SUPPORTED CURB IS NOT DISTURBED DURING PLACEMENT.
4. CONCRETE SHALL BE PLACED AND CONSOLIDATED IN SUCH A MANNER THAT NO VOIDS WILL BE PRESENT WHEN COMPLETE.
5. CONTRACTOR SHALL PLACE CURB JOINTS TO COINCIDE WITH TRUCK APRON EXPANSION AND CONTROL JOINTS.

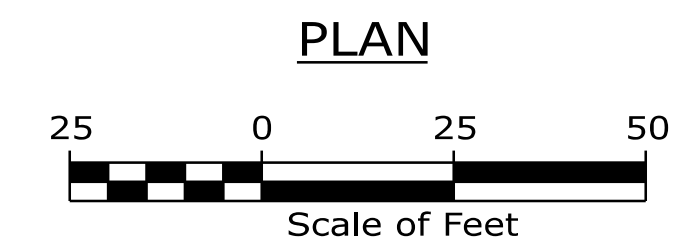

PROJ. MANAGER	BY	DATE	SIGNATURE	P.E. NUMBER	DATE
DESIGN-DETAILED					
CHECKED-REVIEWED					
DESIGN-DETAILED					
REVISIONS 1					
REVISIONS 2					
REVISIONS 3					
REVISIONS 4					
FIELD CHANGES					

WARREN
ROUTE 90 AT WESTERN RD
SPECIAL DETAILS -
CENTRAL TRUCK APRON

SHEET NUMBER

9

OF 64

Date: 2005/09/07

Username:

Division:

Filename: c:\pw_pit\strongwa\44321790\010_special_details.dgn

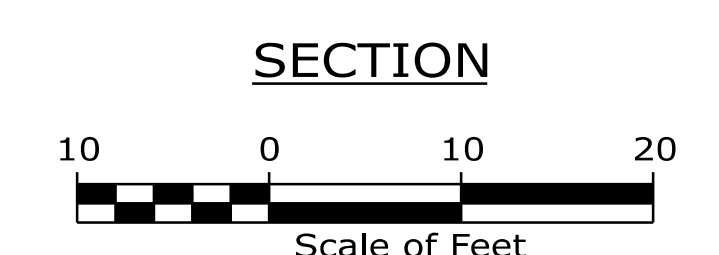
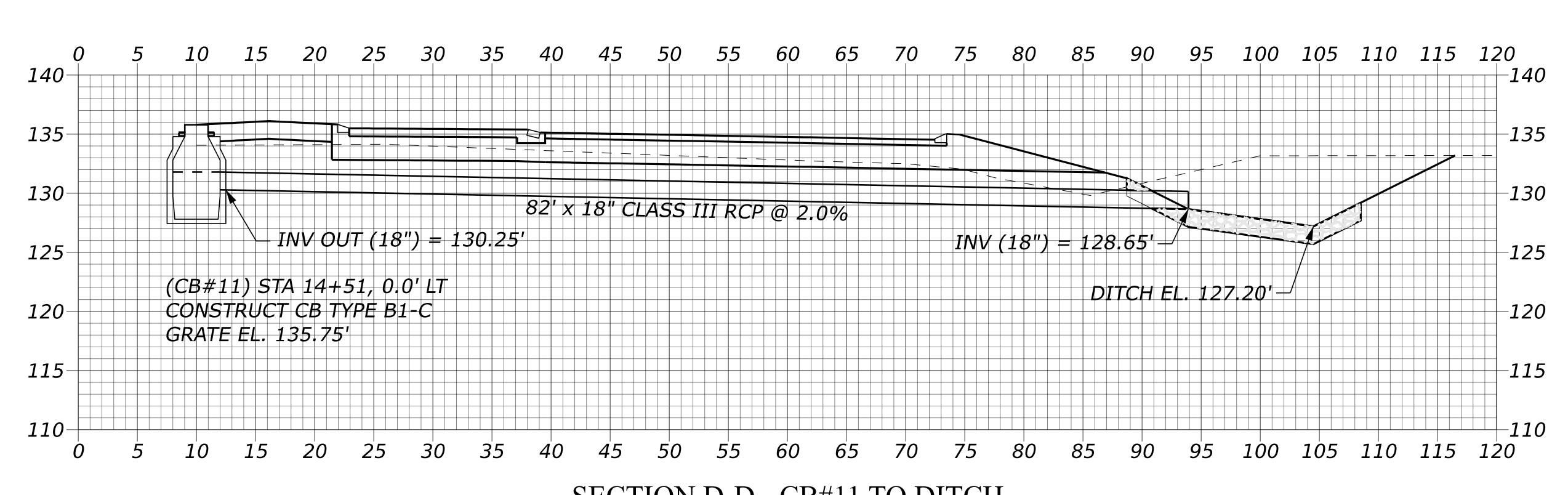
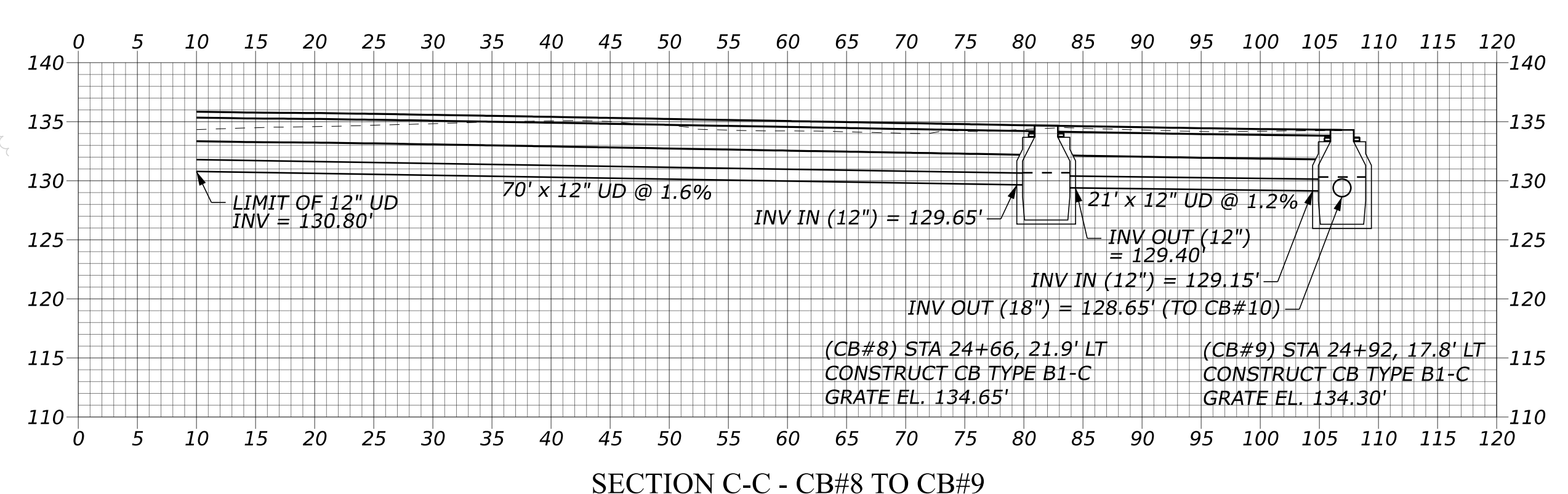
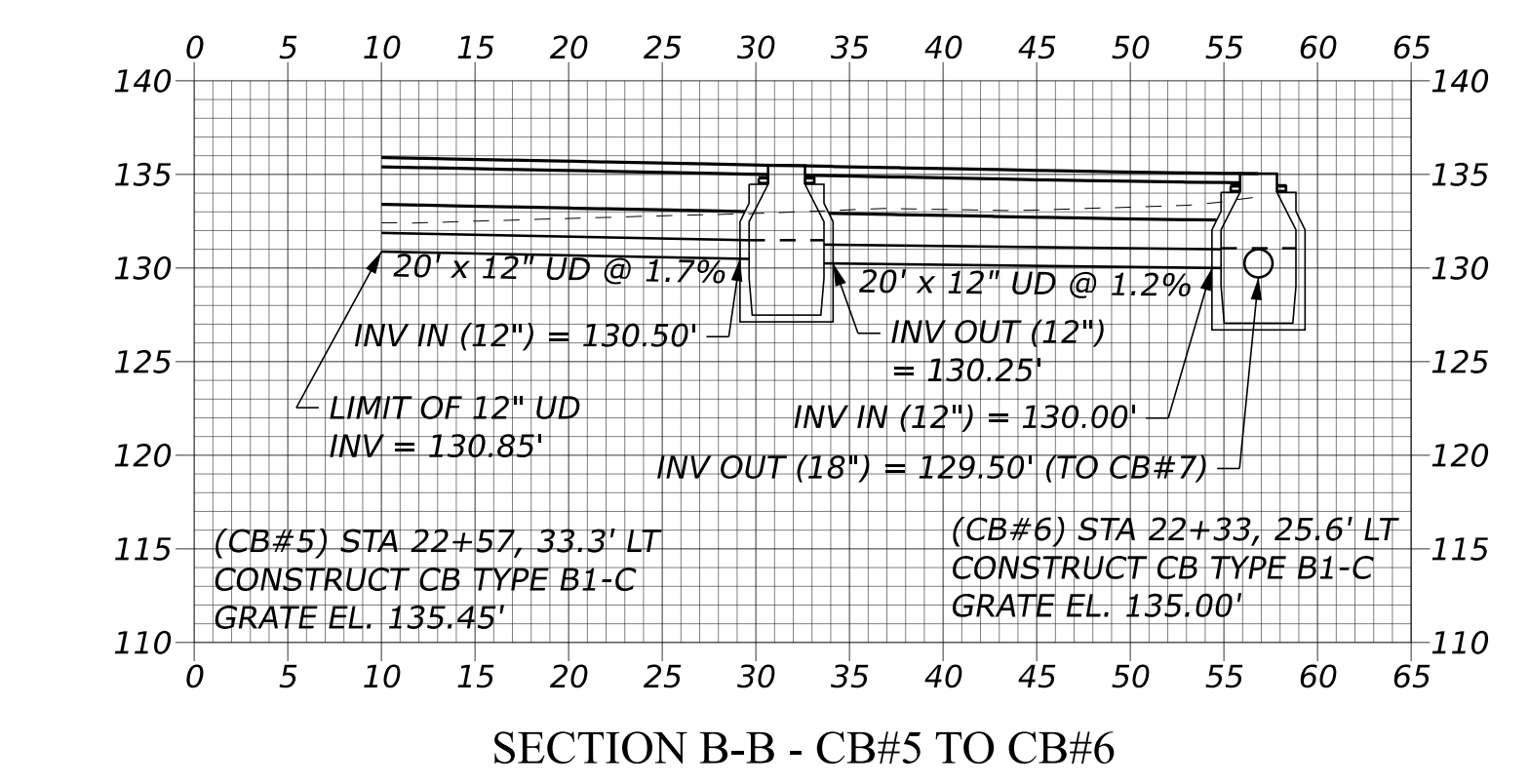
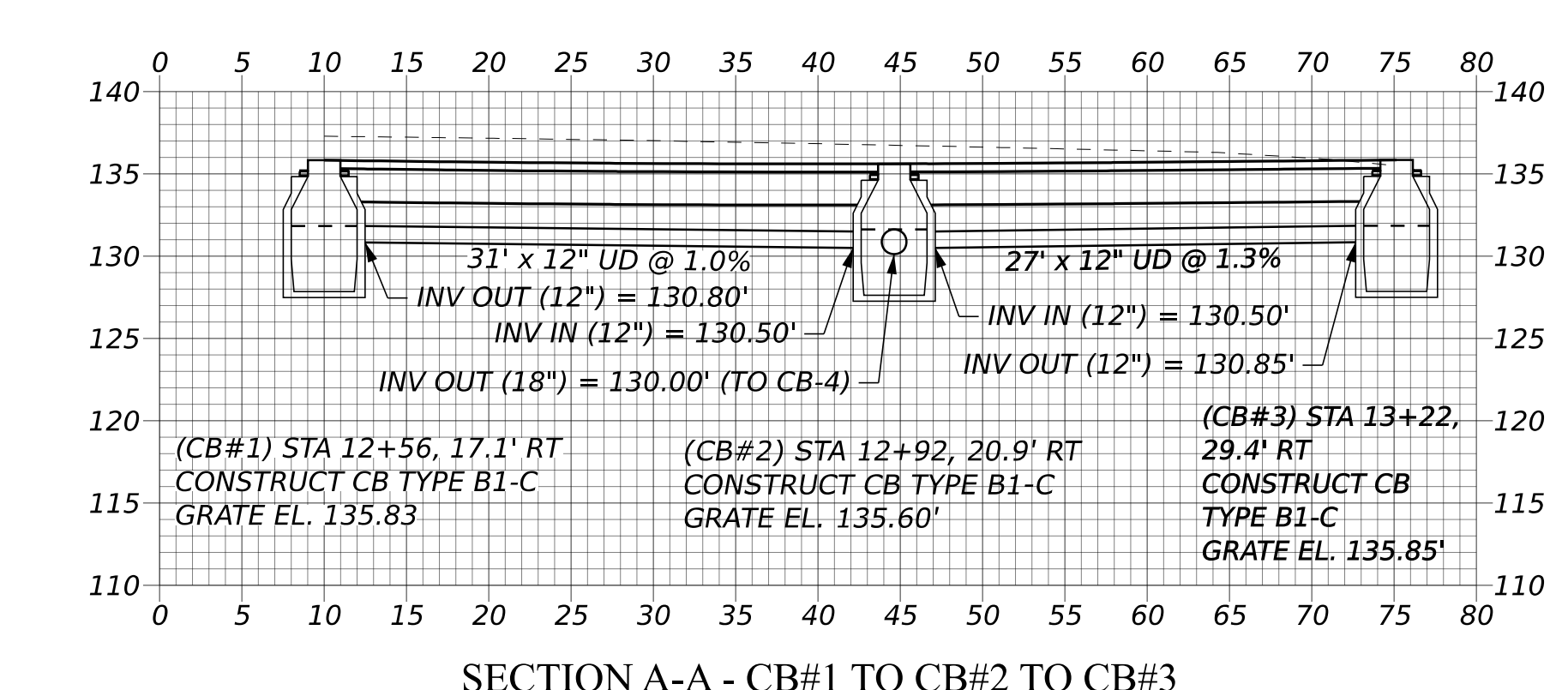
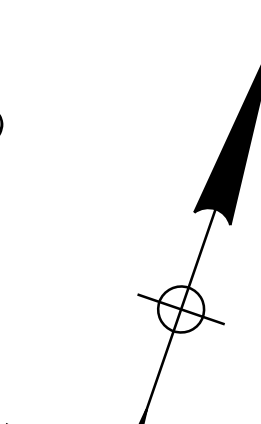
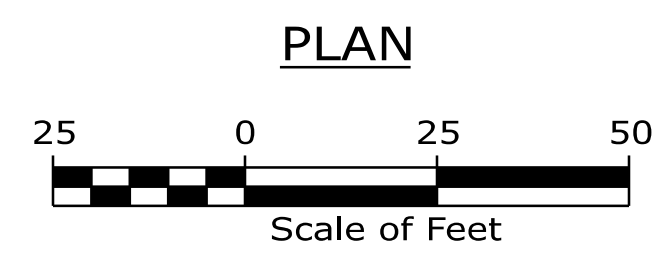
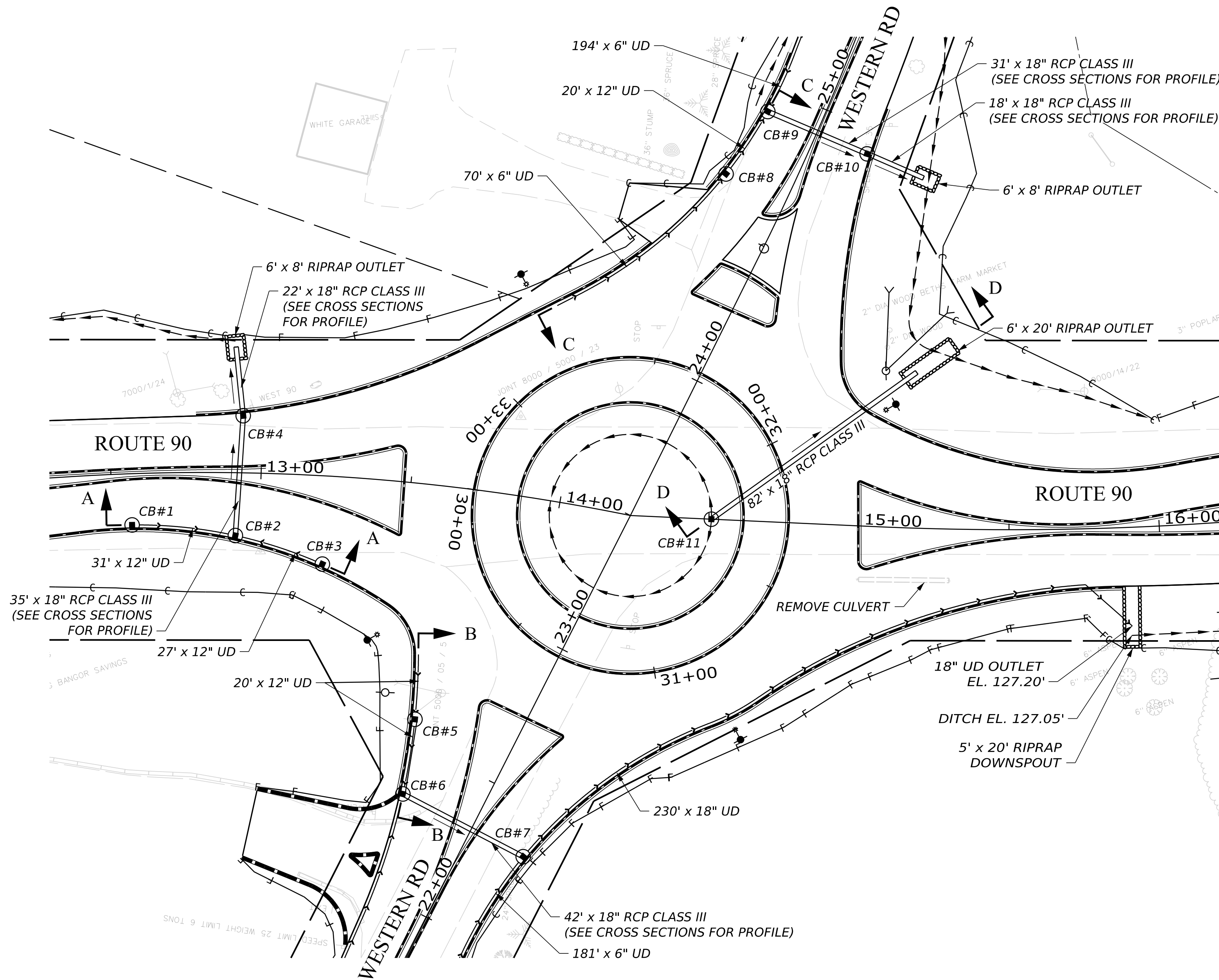

STATE OF MAINE DEPARTMENT OF TRANSPORTATION		HIGHWAY PLANS WIN 27036.00	
DATE	SIGNATURE	P.E. NUMBER	DATE
BY			
PROJ. MANAGER	DESIGN-DETAILED	DESIGN-REVIEWED	DESIGN-FILED
	DESIGN-FILED	DESIGN-FILED	DESIGN-FILED
	REVISIONS 1	REVISIONS 2	REVISIONS 3
	REVISIONS 4	REVISIONS 5	REVISIONS 6
	FIELD CHANGES		
WARREN ROUTE 90 AT WESTERN RD		SPECIAL DETAILS - DRAINAGE	
SHEET NUMBER		10	
		OF 64	

Date: 2005/09/07

Username:

Division:

Filename: c:\pw_pit\strongwa\44321790\011_lighting_plans.dgn

LEGEND	
----	2" NM CONDUIT, 2#8, 1#8 (G)
=====	2" NM CONDUIT (SCH 80), 2#8, 1#8 (G)
●	LIGHT POLE
○	JUNCTION BOX
⊞	LIGHTING CONTROL CABINET
⊙	RELOCATED UTILITY POLE
—	RELOCATED OVERHEAD WIRES
←	GUY WIRE

NOTES:

1. ALL CONDUIT SHALL BE NON-METALLIC CONDUIT UNLESS OTHERWISE NOTED.
2. ALL CONDUIT BENEATH THE ROADWAY SHALL BE NON-METALLIC UNDER PAVEMENT CONDUIT (SCHEDULE 80 OR GREATER).

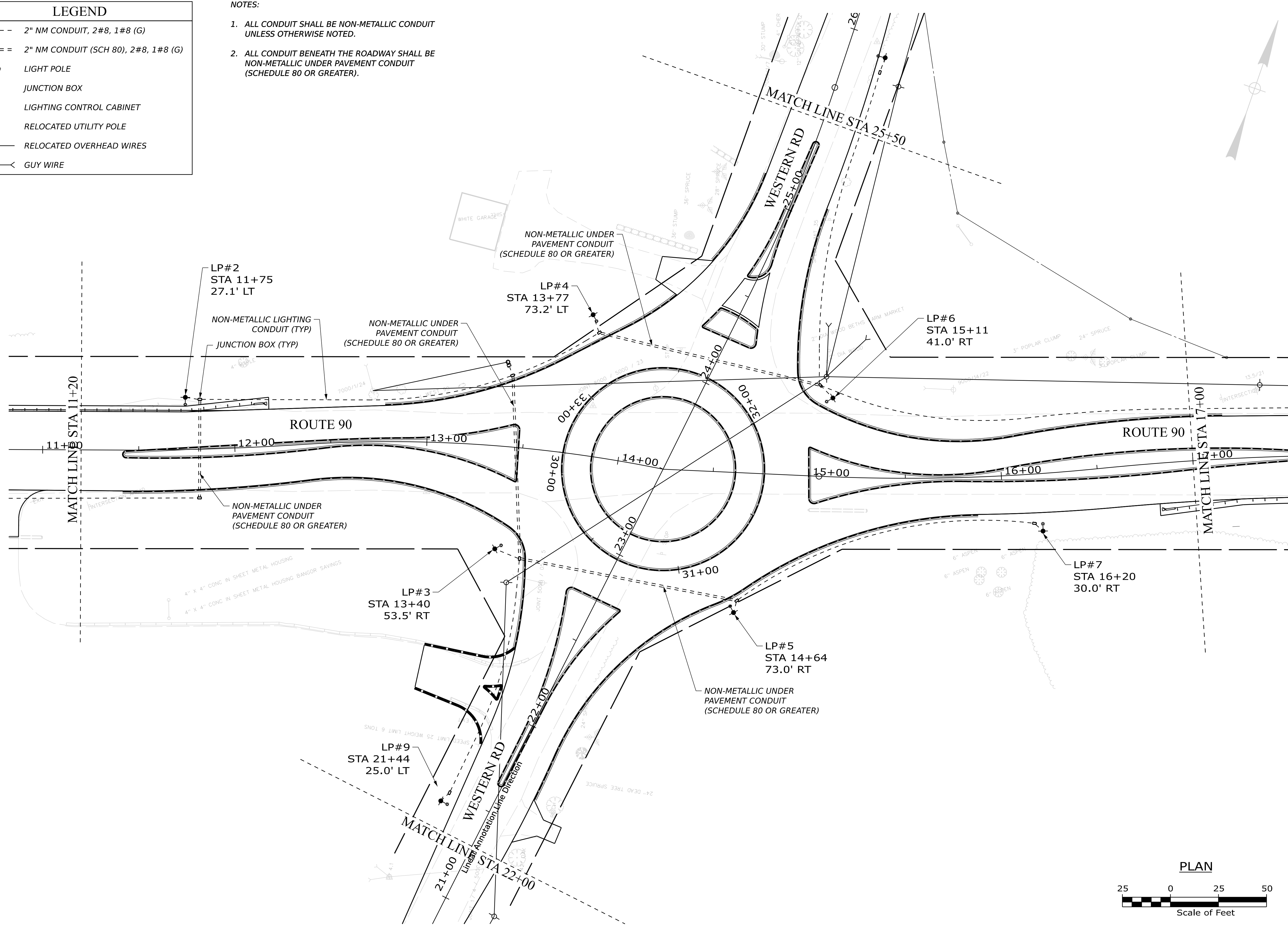

STATE OF MAINE
DEPARTMENT OF TRANSPORTATION

PROJ. MANAGER	BY	DATE	SIGNATURE	P.E. NUMBER	DATE
DESIGN-DETAILED	X	X			
CHECKED-REVIEWED	X	X			
DESIGN-DETAILED	X	X			
DESIGN-DETAILED	X	X			
REVISIONS 1					
REVISIONS 2					
REVISIONS 3					
REVISIONS 4					
FIELD CHANGES					

WARREN
ROUTE 90 AT WESTERN RD
LIGHTING PLANS

SHEET NUMBER

11

OF 64

WIN
27036.00
HIGHWAY PLANS

LEGEND	
----	2" NM CONDUIT, 2#8, 1#8 (G)
====	2" NM CONDUIT (SCH 80), 2#8, 1#8 (G)
⊕	LIGHT POLE
□	JUNCTION BOX
⊠	LIGHTING CONTROL CABINET
⊙	RELOCATED UTILITY POLE
—	RELOCATED OVERHEAD WIRES
←	GUY WIRE

NOTES:

1. ALL CONDUIT SHALL BE NON-METALLIC CONDUIT UNLESS OTHERWISE NOTED.
2. ALL CONDUIT BENEATH THE ROADWAY SHALL BE NON-METALLIC UNDER PAVEMENT CONDUIT (SCHEDULE 80 OR GREATER).

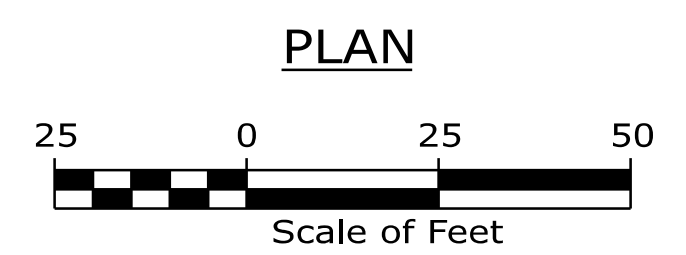
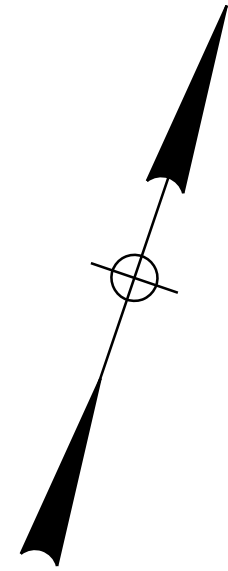
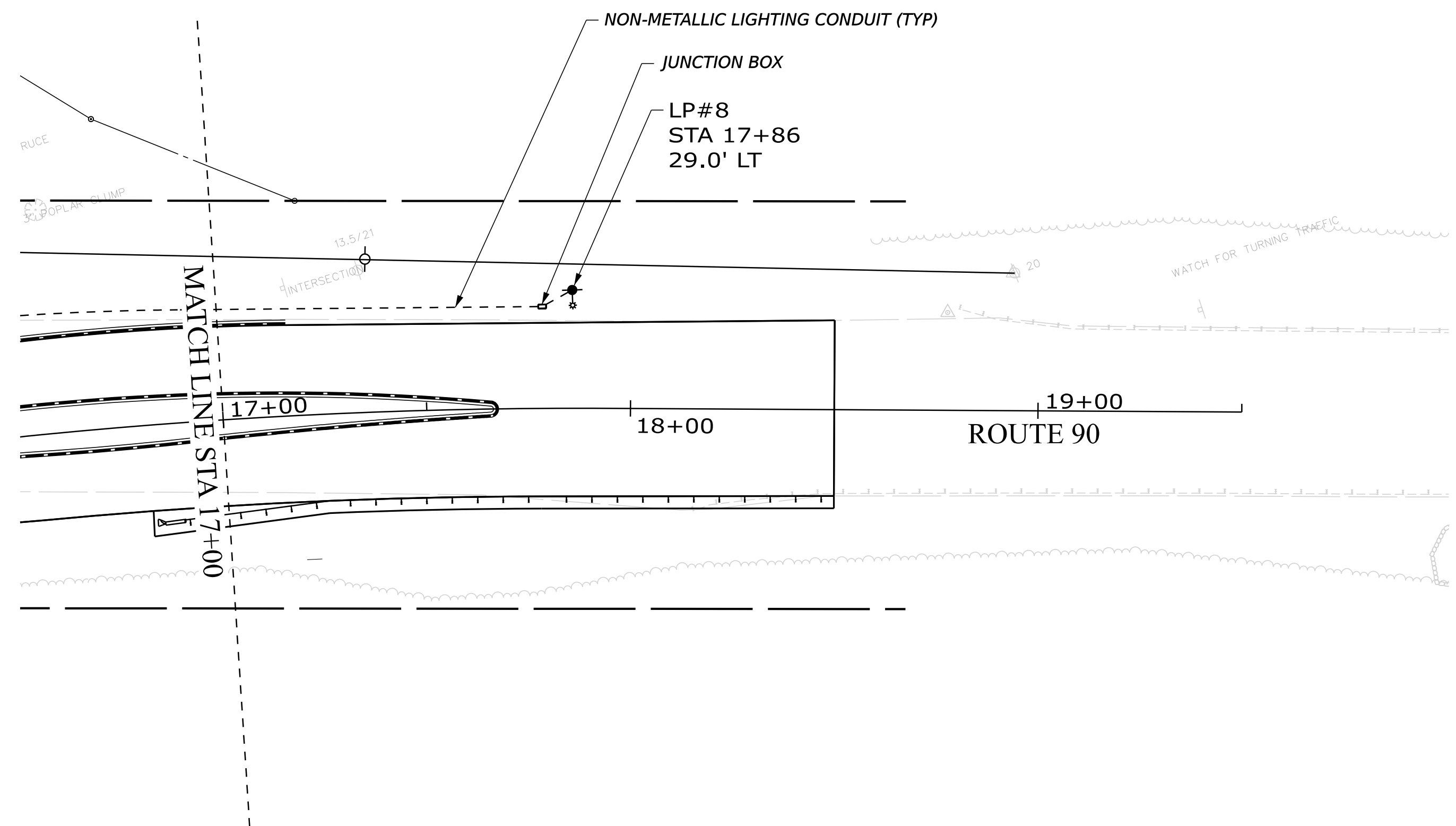
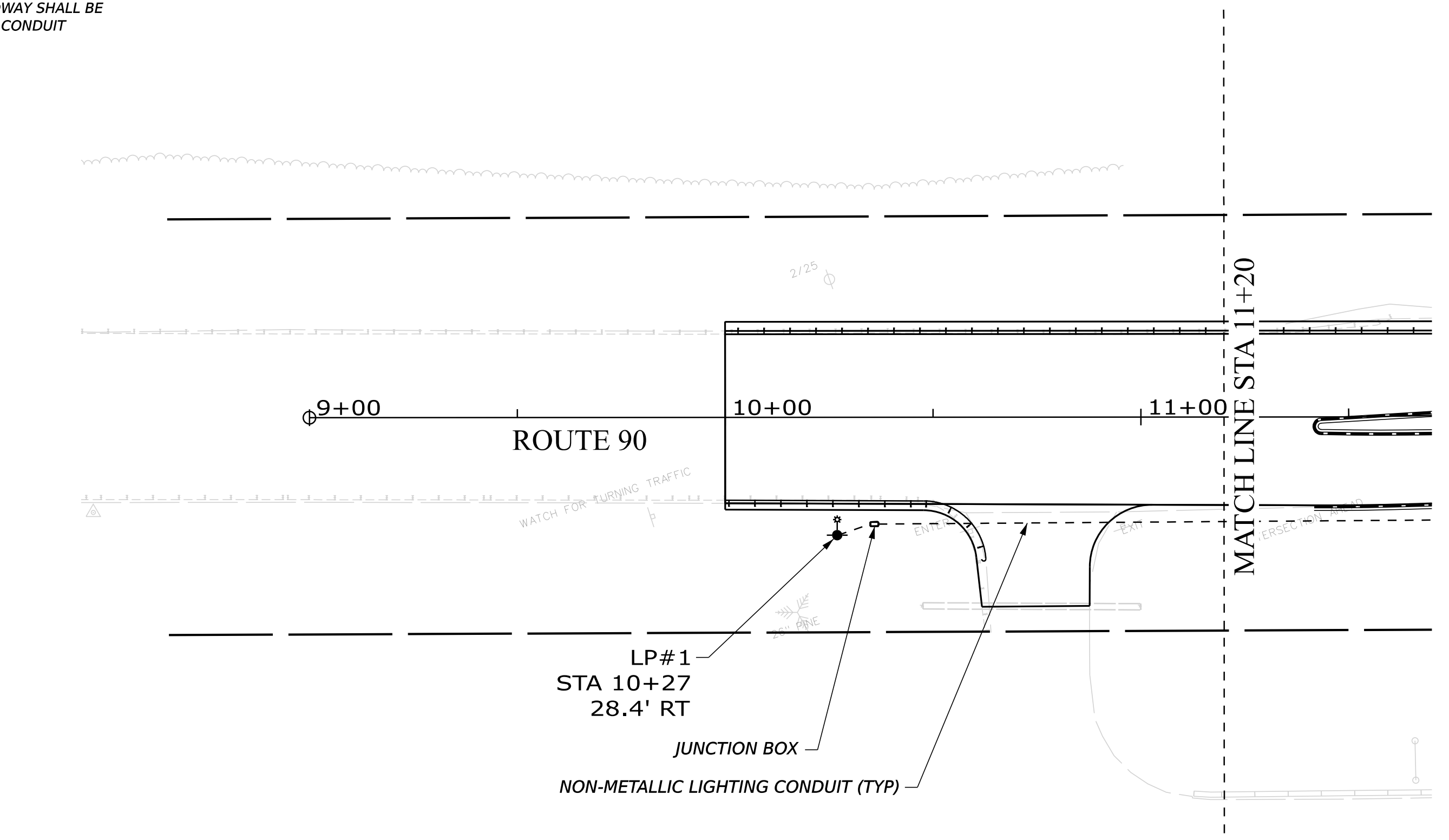

STATE OF MAINE
DEPARTMENT OF TRANSPORTATION

WARREN
ROUTE 90 AT WESTERN RD
LIGHTING PLANS

PROJ. MANAGER	BY	DATE
DESIGN-DETAILED		
CHECKED-REVIEWED		
DESIGN-DETAILED		
DESIGN-DETAILED		
REVISIONS 1		
REVISIONS 2		
REVISIONS 3		
REVISIONS 4		
FIELD CHANGES		

SHEET NUMBER
12
OF 64

WIN
27036.00
HIGHWAY PLANS

LEGEND	
-----	2" NM CONDUIT, 2#8, 1#8 (G)
====	2" NM CONDUIT (SCH 80), 2#8, 1#8 (G)
⊙	LIGHT POLE
□	JUNCTION BOX
⊞	LIGHTING CONTROL CABINET
⊙	RELOCATED UTILITY POLE
—	RELOCATED OVERHEAD WIRES
—	GUY WIRE

NOTES:

1. ALL CONDUIT SHALL BE NON-METALLIC CONDUIT UNLESS OTHERWISE NOTED.
2. ALL CONDUIT BENEATH THE ROADWAY SHALL BE NON-METALLIC UNDER PAVEMENT CONDUIT (SCHEDULE 80 OR GREATER).

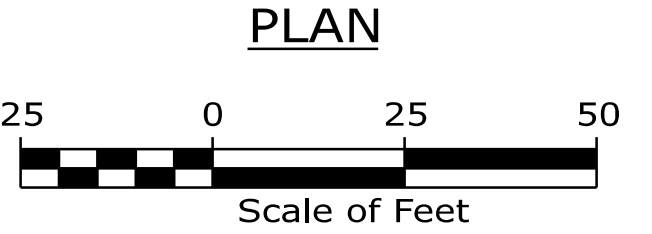
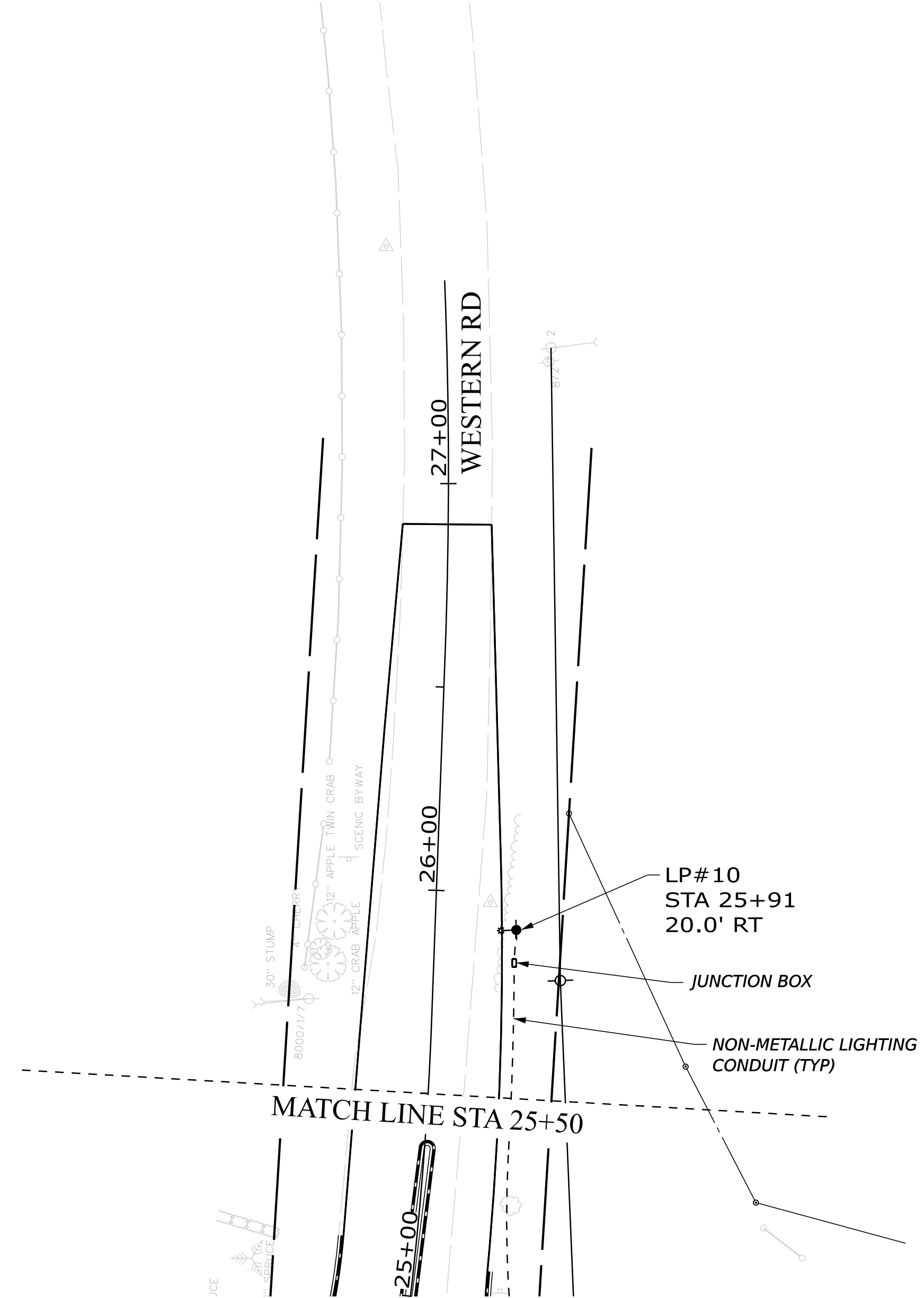
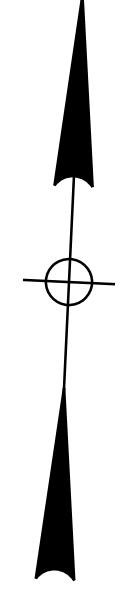
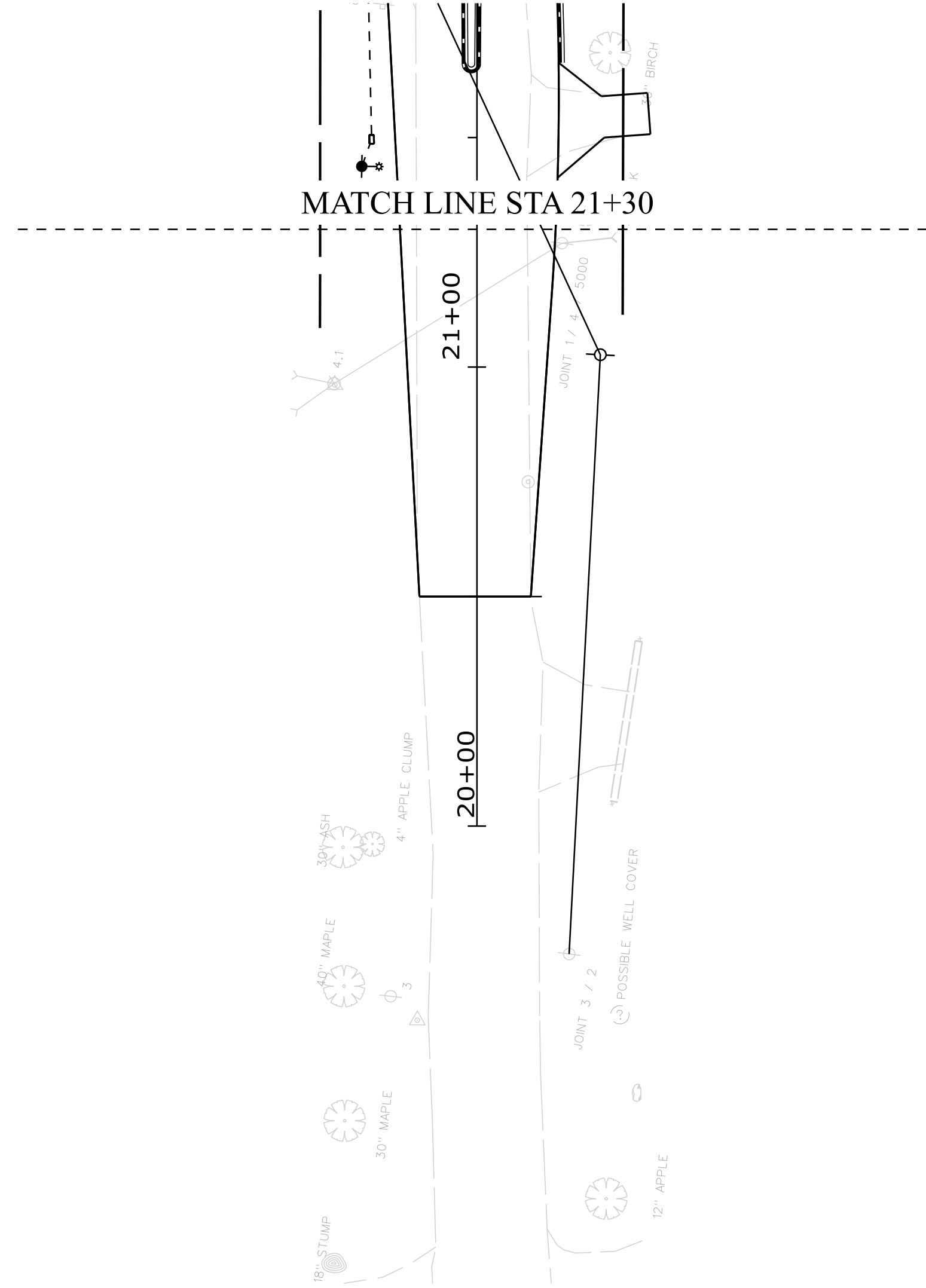
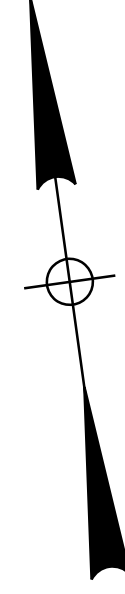

STATE OF MAINE DEPARTMENT OF TRANSPORTATION		SIGNATURE	
		P.E. NUMBER	
WARREN ROUTE 90 AT WESTERN RD LIGHTING PLANS		PROJ. MANAGER	DATE
		DESIGN-DETAILED	
		CHECKED-REVIEWED	
		DESIGN-DETAILED	
SHEET NUMBER 13 OF 64		REVISIONS 1	DATE
		REVISIONS 2	
		REVISIONS 3	
		REVISIONS 4	
HIGHWAY PLANS		WIN	27036.00

DESCRIPTION	SYMBOL	AVERAGE	MAX	MIN	MAX/MIN	AVG/MIN
ROUTE 90 (WEST)	+	X	X	X	X	X
ROUTE 90 (EAST)	+	X	X	X	X	X
WESTERN RD (SOUTH)	+	X	X	X	X	X
WESTERN RD (NORTH)	+	X	X	X	X	X
ROUNDBABOUT CENTER	+	X	X	X	X	X

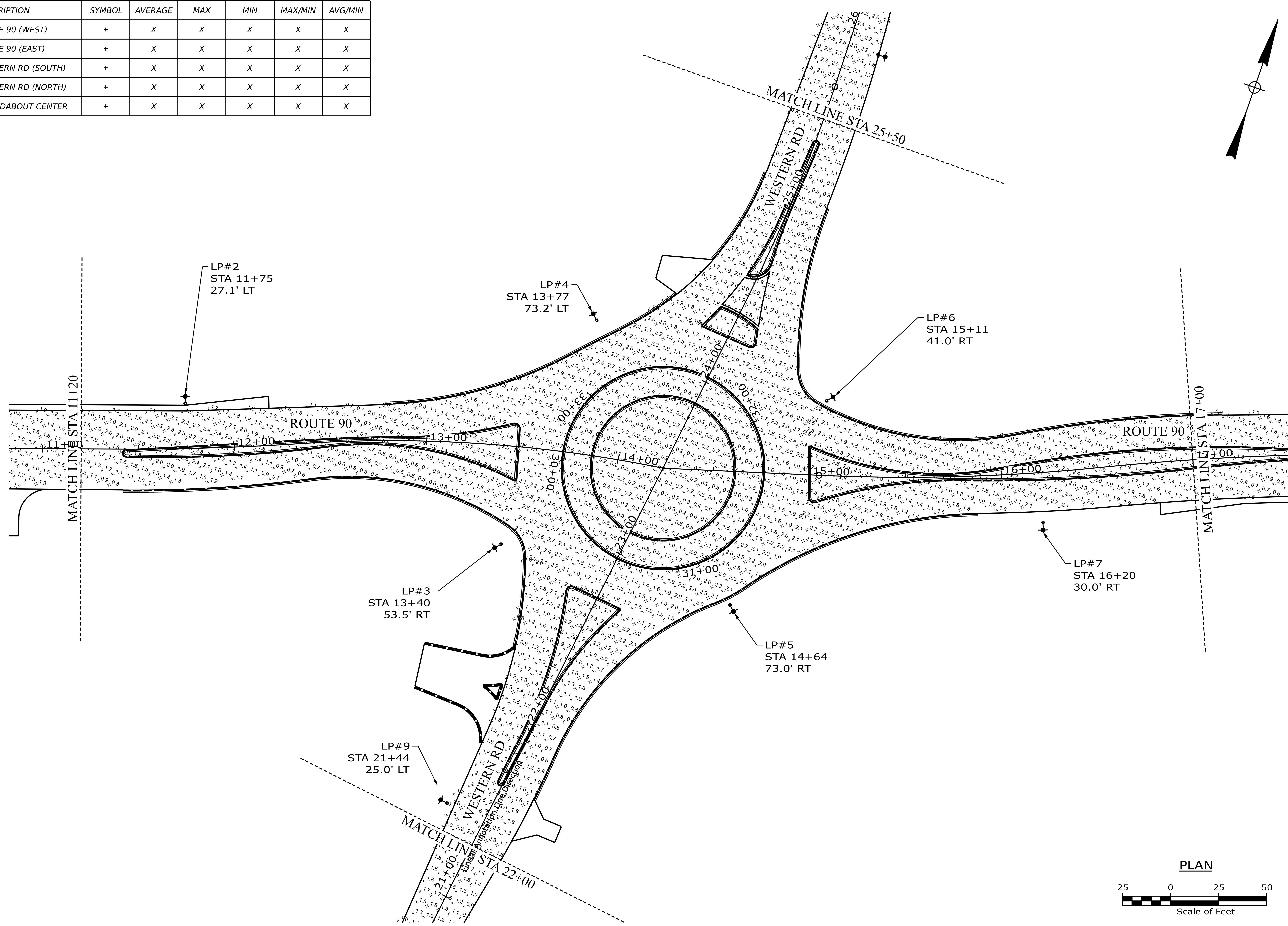

PROJ. MANAGER	DATE	BY	DATE
DESIGN-DETAILED	X	X	X
CHECKED-REVIEWED	X	X	X
DESIGN-DETAILED	X	X	X
DESIGN-DETAILED	X	X	X
REVISIONS 1			
REVISIONS 2			
REVISIONS 3			
REVISIONS 4			
FIELD CHANGES			

SIGNATURE	P.E. NUMBER	DATE

WARREN
ROUTE 90 AT WESTERN RD
LIGHTING PLANS

DESCRIPTION	SYMBOL	AVERAGE	MAX	MIN	MAX/MIN	AVG/MIN
ROUTE 90 (WEST)	+	X	X	X	X	X
ROUTE 90 (EAST)	+	X	X	X	X	X
WESTERN RD (SOUTH)	+	X	X	X	X	X
WESTERN RD (NORTH)	+	X	X	X	X	X
ROUNDBOUT CENTER	+	X	X	X	X	X

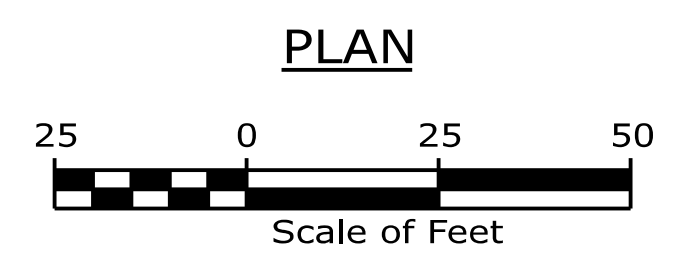
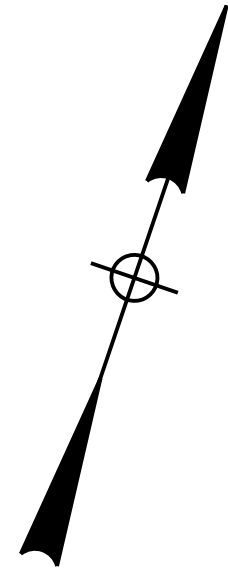
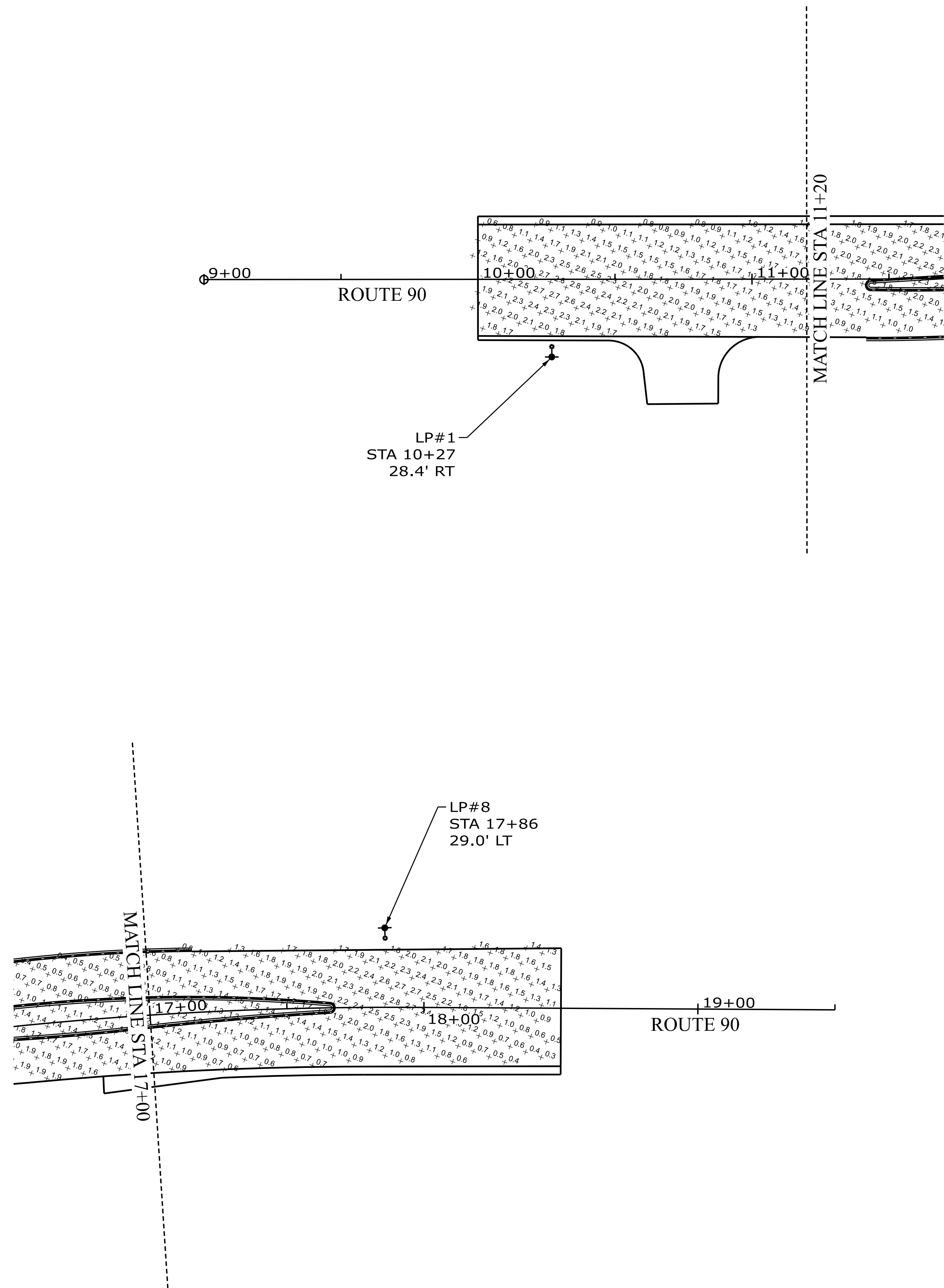

STATE OF MAINE DEPARTMENT OF TRANSPORTATION		WIN 27036.00 HIGHWAY PLANS
	SIGNATURE	DATE
	P.E. NUMBER	DATE
PROJ. MANAGER	BY	DATE
DESIGN-DETAILED		
CHECKED-REVIEWED		
DESIGN-DETAILED		
DESIGN-DETAILED		
REVISIONS 1		
REVISIONS 2		
REVISIONS 3		
REVISIONS 4		
FIELD CHANGES		
WARREN ROUTE 90 AT WESTERN RD LIGHTING PLANS		
SHEET NUMBER 15 OF 64		

DESCRIPTION	SYMBOL	AVERAGE	MAX	MIN	MAX/MIN	AVG/MIN
ROUTE 90 (WEST)	+	X	X	X	X	X
ROUTE 90 (EAST)	+	X	X	X	X	X
WESTERN RD (SOUTH)	+	X	X	X	X	X
WESTERN RD (NORTH)	+	X	X	X	X	X
ROUNDAABOUT CENTER	+	X	X	X	X	X

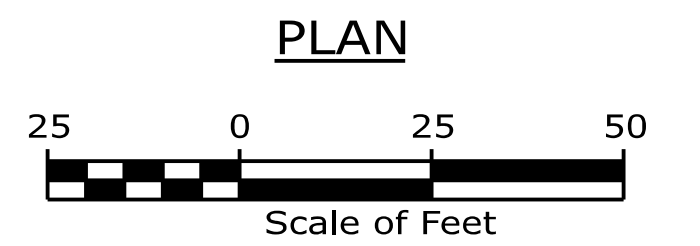
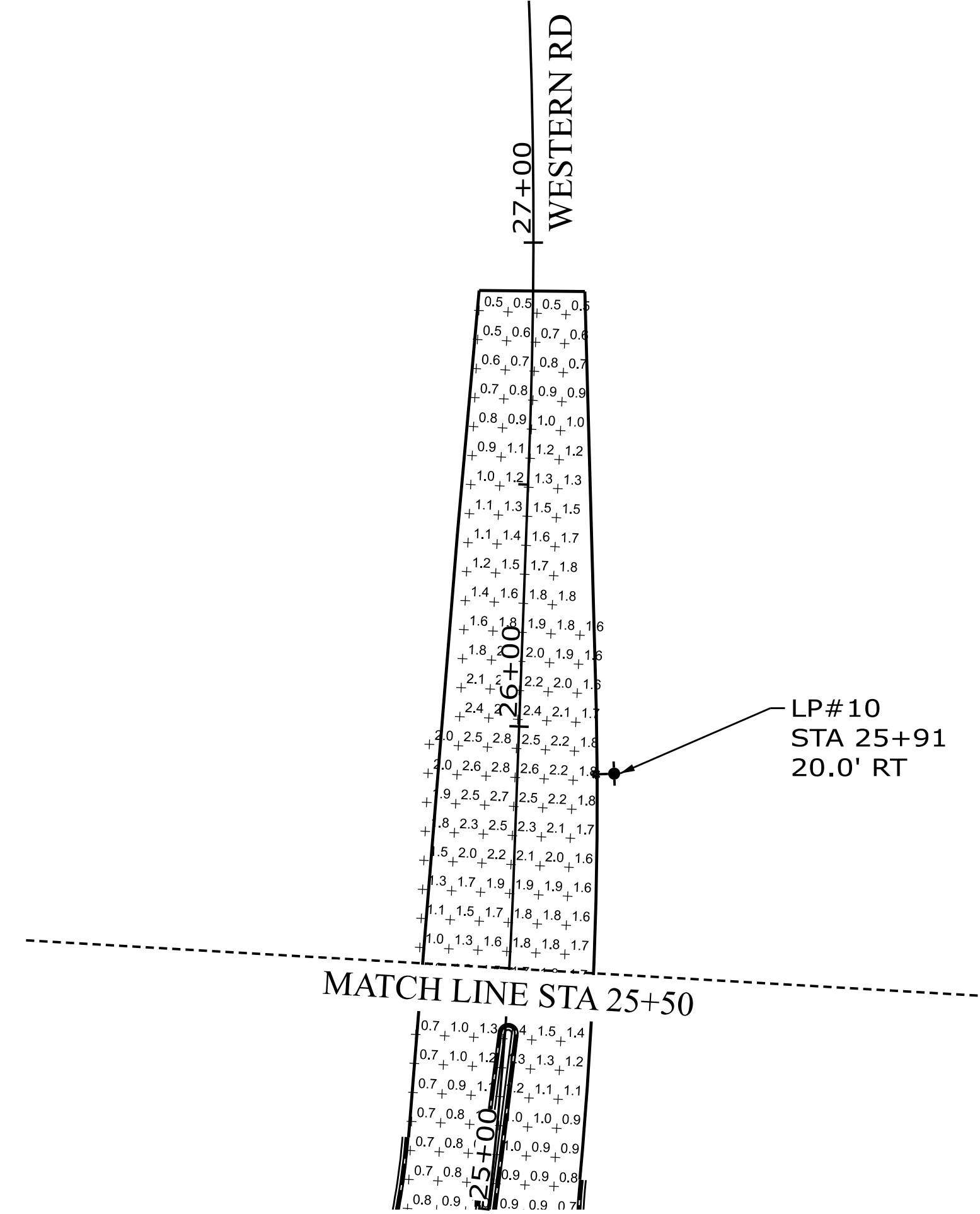
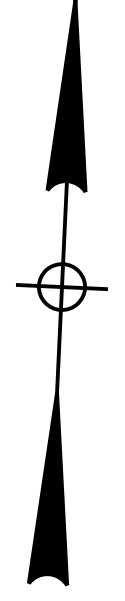
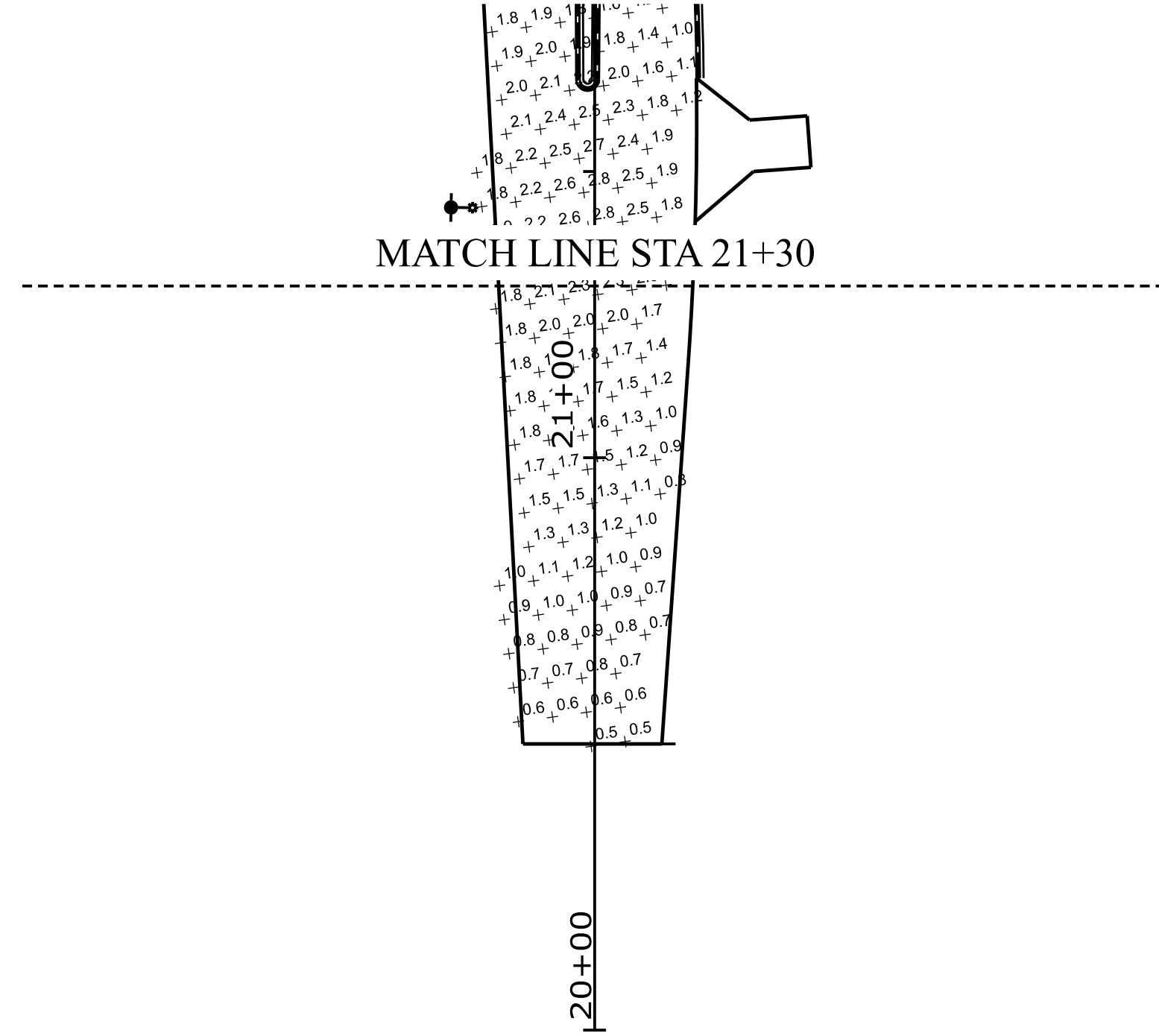
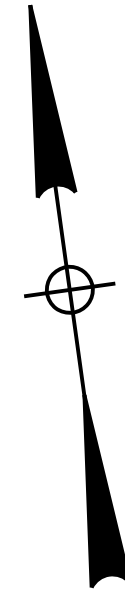

STATE OF MAINE
DEPARTMENT OF TRANSPORTATION

PROJ. MANAGER	BY	DATE
DESIGN-DETAILED		
CHECKED-REVIEWED		
DESIGN-DETAILED		
REVISIONS 1		
REVISIONS 2		
REVISIONS 3		
REVISIONS 4		
FIELD CHANGES		

WARREN
ROUTE 90 AT WESTERN RD
LIGHTING PLANS

SHEET NUMBER
16
OF 64

WIN
27036.00
HIGHWAY PLANS

SIGNATURE
P.E. NUMBER
DATE

- SCOPE OF WORK - INSTALL HIGHWAY LIGHTING AS SHOWN ON THIS PLAN. INSTALL NEW CONDUIT, WIRING, FOUNDATIONS, POLES, LED LUMINAIRES AND RELATED HARDWARE.
- ALL MATERIALS AND WORKMANSHIP SHALL CONFORM TO APPLICABLE PROVISIONS OF THE MAINE DEPARTMENT OF TRANSPORTATION STANDARD SPECIFICATIONS AND STANDARD DETAILS, NATIONAL ELECTRICAL CODE AND ANY REQUIREMENTS OF THE UTILITY COMPANY.
- THE CONTRACTOR SHALL FIELD VERIFY POLE LOCATIONS TO AVOID NATURAL AND BUILT SITE FEATURES THAT WOULD CONFLICT WITH PROPER INSTALLATION OF POLE FOUNDATIONS.
- THE CONTRACTOR SHALL VISIT THE SITE PRIOR TO BIDDING TO ENSURE AWARENESS OF SITE CONDITIONS THAT COULD AFFECT THE BID.
- FIXTURES SHALL BE IES FULL CUTOFF, INDIRECT VIEW LIGHT EMITTING DIODE (LED) FIXTURES. IES DISTRIBUTION TYPE SHALL BE AS SHOWN ON THE PLANS. FIXTURE VOLTAGE SHALL BE 240 VOLTS.
- LIGHT STANDARDS SHALL BE ROUND TAPERED ALUMINUM, WITH POLYESTER POWDER COAT BLACK PAINT FINISH.
- LIGHT STANDARDS SHALL BE MANUFACTURED BY VALMONT, MODEL R-380860106T4-D1-DBL OR R-380860108T4-D1-DBL.
- LIGHT STANDARDS SHALL BE EQUIPPED WITH A SINGLE ARM ASSEMBLY, MODEL 1HT90-DBL.
- LIGHT STANDARDS SHALL BE EQUIPPED WITH BREAKAWAY POLE BASES MANUFACTURED BY TRANSPO, MODEL 4100.
- LIGHT STANDARDS SHALL BE EQUIPPED WITH POLE BASE COVERS MANUFACTURED BY VALMONT, MODEL 2T03AC-DBL.
- FIXTURES SHALL BE GASKETED, HAVE AN EXTENDED LIFE DRIVER, SURGE PROTECTION, AND A DOUBLE FUSE KIT. ALL FIXTURES SHALL BE ALUMINUM WITH POLYESTER POWDER COAT BLACK PAINT FINISH. THE LIGHTING LAYOUT WAS DONE USING AMERICAN ELECTRIC LIGHTING AUTOBAHN SERIES ATB0, MODEL NUMBER ATB0-P452-MVOLT-R2 WITH HOUSE-SIDE SHIELD ACCESSORY AND 3 PIN NEMA PHOTOCONTROL RECEPTACLE. IF DIFFERENT FIXTURES ARE PROPOSED, THEY SHALL BE IES FULL CUTOFF, TYPE 2 OR 3 IES DISTRIBUTION, INDIRECT VIEW LED LUMINAIRES WITH PHOTOCONTROL RECEPTACLE OR INTEGRATED PHOTOCONTROL. THE CONTRACTOR MUST DEMONSTRATE THAT THE PROPOSED FIXTURES WILL REASONABLY EQUAL THE LIGHT LEVELS AND DISTRIBUTION SHOWN ON THE PLANS, IN THE OPINION OF MAINEDOT.
- EVALUATION BY MAINEDOT OF ALTERNATIVE LED LUMINAIRES THAT MAY BE PROPOSED BY THE CONTRACTOR FOR SUBSTITUTION WILL REQUIRE SUBMITTAL OF THE FOLLOWING, AT A MINIMUM:
 IES LM-79-08 ABSOLUTE TESTING REPORT FOR THE PROPOSED ALTERNATIVE LUMINAIRE;
 IES LM-80-08 TESTING REPORT FOR LED CHIPS TO BE USED IN THE ALTERNATIVE LUMINAIRE, DOCUMENTING TESTING FOR A MINIMUM OF 8500 HOURS;
 IES TM-21-11 REPORT FOR PROJECTED LONG TERM LUMEN MAINTENANCE, INCLUDING INCREMENTAL LUMEN DEPRECIATION TABLE AT 25 DEGREES CELSIUS TO A MINIMUM OF 50,000 HOURS;
 IES ELECTRONIC PHOTOMETRIC FILE FROM THE MANUFACTURER FOR THE PROPOSED ALTERNATIVE LUMINAIRE;
 PHOTOMETRIC PLOT, OVERLAID ON THE LAYOUT OF THE LUMINAIRE LOCATIONS FOR THIS SPECIFIC PROJECT, SHOWING LIGHT CONTOURS, ILLUMINATION STATISTICS FOR EACH OF THE LIGHTING ANALYSIS AREAS, AND VALUE OF LIGHT LOSS FACTOR USED IN THE ANALYSIS;
 VALUES OF LLD, LDD, AND OTHER FACTORS USED FOR CALCULATION OF THE ASSUMED LIGHT LOSS FACTOR;
 SPECIFICATION DATA REGARDING OPTICS, CHROMATIC COLOR TEMPERATURE, DRIVER, PHOTOCONTROL, SURGE PROTECTION, HOUSING AND GASKETING.
- ALL CONDUITS SHALL BE 2" MINIMUM SCHEDULE 40 PVC DIRECT-BURIED, UNLESS OTHERWISE NOTED. MINIMUM BURIAL DEPTH FOR CONDUIT SHALL BE 36".
- CONDUITS UNDER ROADWAY SHALL BE SCHEDULE 80 PVC.
- ALL WIRES FOR LIGHTING CIRCUITS SHALL BE A MINIMUM OF 8 AWG WIRE. ALL WIRE FROM THE CONTROL CABINET TO THE LIGHT POLE BASE SHALL BE A MINIMUM OF 8 AWG THWN WIRE.
- ALL ELECTRICAL HANDHOLES SHALL BE H-20 RATED.
- IF STRUCTURAL ROCK IS ENCOUNTERED DURING INSTALLATION OF FOUNDATIONS, PAYMENT FOR EXCAVATION AND DOWELING REINFORCING INTO ROCK SHALL BE CONSIDERED INCIDENTAL TO THE FOUNDATION ITEMS.
- PAYMENT UNDER ITEM 634.160 - HIGHWAY LIGHTING WILL INCLUDE ALL MATERIALS, LABOR AND EQUIPMENT NECESSARY TO PROVIDE A FULLY FUNCTIONING HIGHWAY LIGHTING SYSTEM, EXCEPT THOSE ITEMS TO BE PAID FOR UNDER OTHER RELATED BID ITEMS IN THE CONTRACT.
- ALL LIGHT BASES SHALL HAVE A GROUND ROD, LOCATED IN THE FOUNDATION, THAT IS BONDED TO THE GROUNDING CONDUCTOR. PAYMENT FOR THE GROUND ROD SHALL BE INCLUDED UNDER ITEM 634.160 - HIGHWAY LIGHTING.
- PAYMENT UNDER ITEM 634.210 - CONVENTIONAL LIGHT STANDARD INCLUDES, BUT IS NOT LIMITED TO, NEW POLES, TRANSFORMER BASES AND BREAKAWAY DEVICES.
- CONTRACTOR SHALL FURNISH A SET OF AS-BUILT PLANS FOR FUTURE REFERENCE AND SYSTEM MAINTENANCE UPON COMPLETION OF THE PROJECT.
- PROVIDE ELECTRIC SERVICE UNDER ITEM 634.25 AND CONFORM TO THE REQUIREMENTS OF SECTION 716.11 - SERVICE EQUIPMENT.

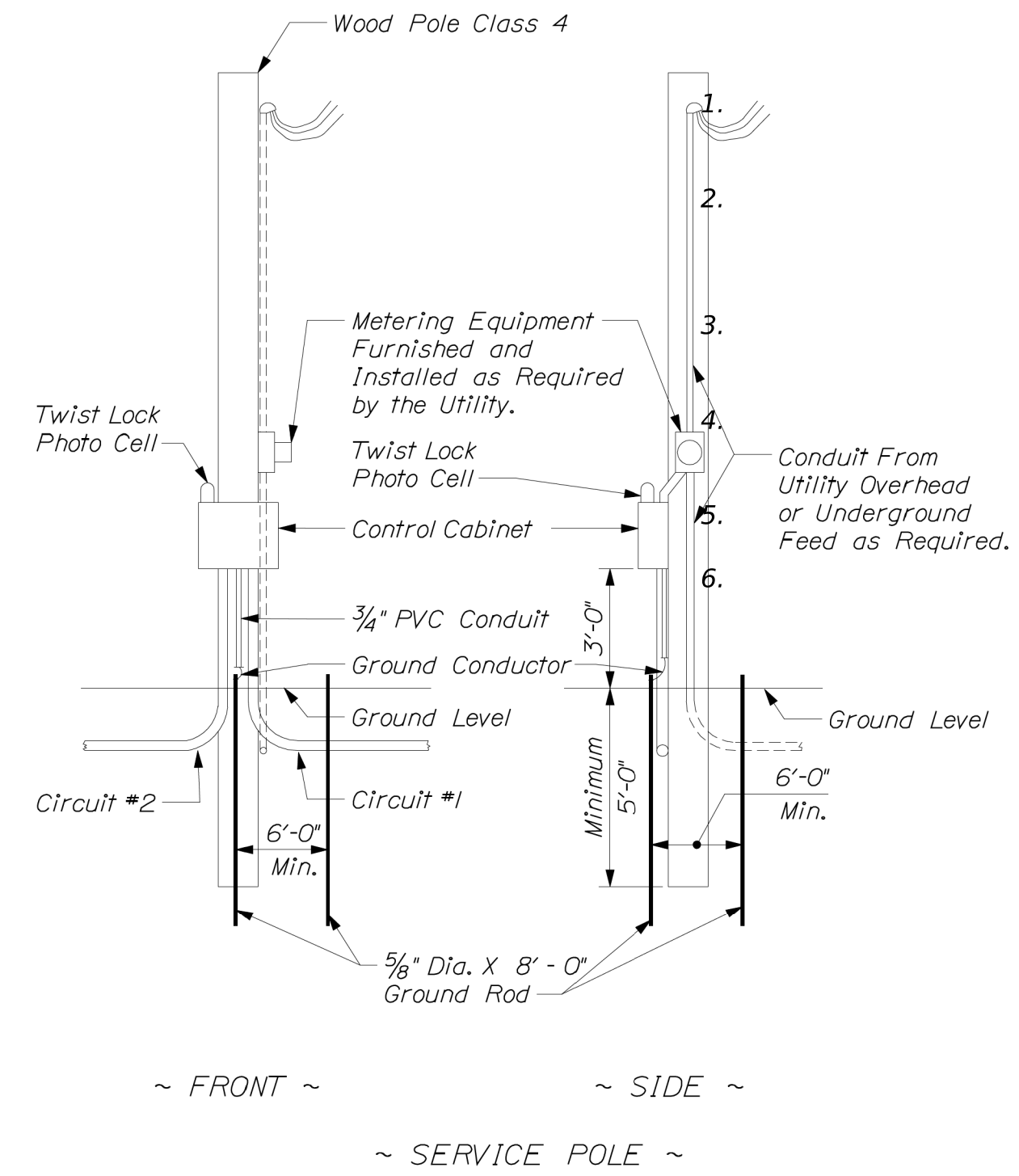

HIGHWAY LIGHTING
634(01)

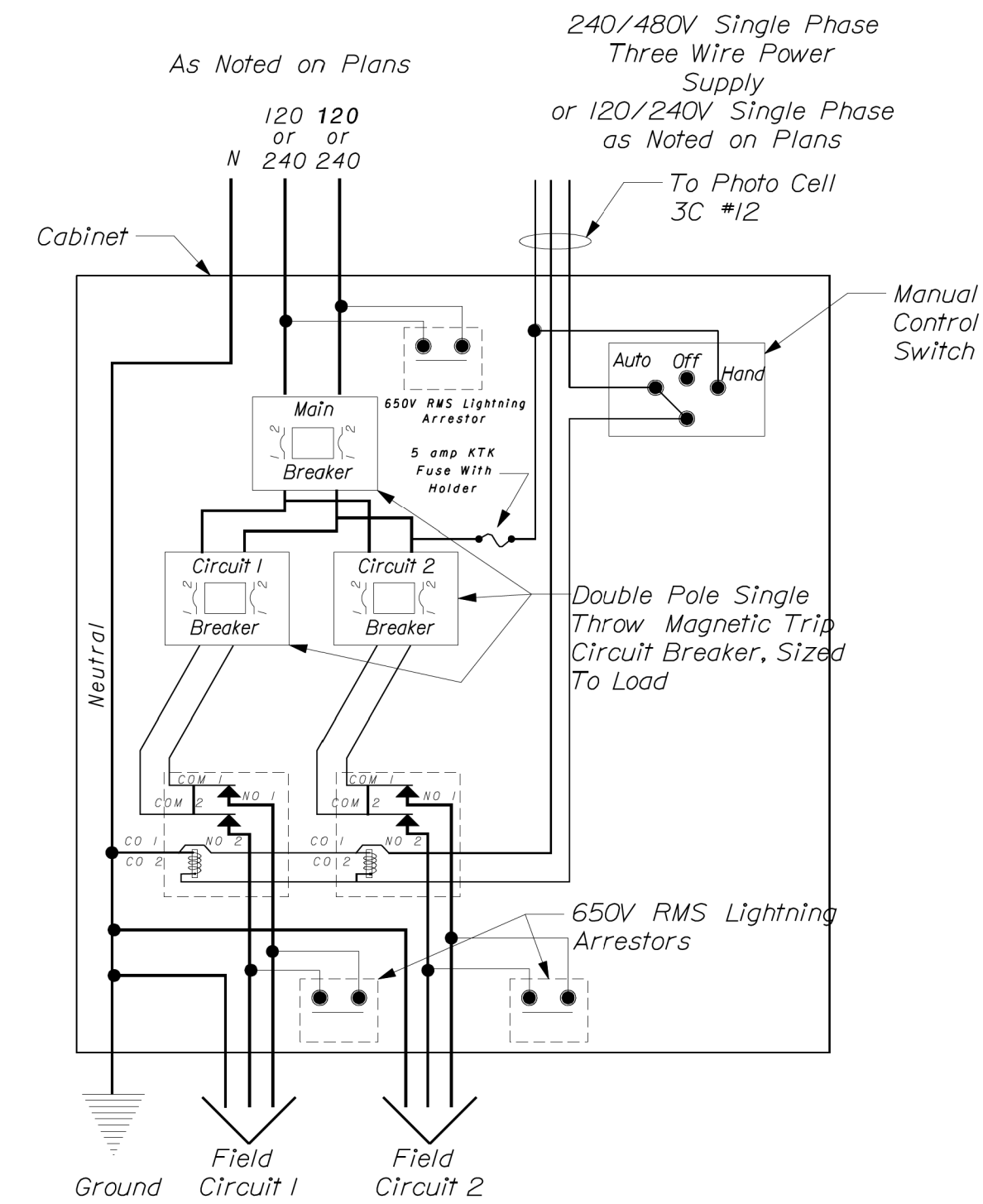

~ SCHEMATIC FOR STREET LIGHTING CONTROL CABINET - MULTI CIRCUIT ~

HIGHWAY LIGHTING
634(03)

PROJ. MANAGER	DATE

ALIGNMENT DATA FOR AL-8				
	STATION	X COORD	Y COORD	
TANGENT				
POB	80+00.00	1606438.68	226185.29	
PC	81+08.66	1606541.26	226221.11	
BEARING	N70°45'10.8"E			
LENGTH	108.66			
CURVE				
PC	81+08.66	1606541.26	226221.11	
PI	81+45.01	1606575.59	226233.09	
CC		1606100.20	227484.32	
PRC	81+81.35	1606609.21	226246.93	
R	1338.00			
Δ	03°06'46.771"			
D	25°48'32.07"			
L	72.70			
T	36.36			
CHORD	72.69			
M.O.	0.49			
E	0.49			
TANGENT				
POB	81+81.35	1606609.21	226246.93	
PC	82+83.54	1606703.71	226285.80	
BEARING	N67°38'24.0"E			
LENGTH	102.18			
CURVE				
PC	82+83.54	1606703.71	226285.80	
PI	83+30.23	1606746.90	226303.56	
CC		1606619.26	226491.11	
PRC	83+75.59	1606779.27	226337.22	
R	222.00			
Δ	23°45'29.461"			
D	84°40'29.261"			
L	92.05			
T	46.70			
CHORD	91.40			
M.O.	4.75			
E	4.86			
TANGENT				
POB	83+75.59	1606779.27	226337.22	
PC	84+14.12	1606805.98	226.365.00	
BEARING	N43°52'51.6"E			
LENGTH	38.53			
CURVE				
PRC	84+14.12	1606805.98	226365.00	
PI	84+72.41	1606846.38	226407.01	
CC		1606696.42	226470.36	
PT	85+25.44	1606848.33	226465.26	
R	152.00			
Δ	41°57'41.937"			
D	123°40'10.824"			
L	111.32			
T	58.29			
CHORD	108.85			
M.O.	10.08			
E	10.79			
TANGENT				
PT	85+25.44	1606848.33	226465.26	
PC	86+50.26	1606852.52	226590.01	
BEARING	N1°55'12.00"E			
LENGTH	124.82			
CURVE				
PC	86+50.26	1606852.52	226590.01	
PI	86+75.64	1606853.36	226615.20	
CC		1605665.18	226629.81	
POE	87+00.66	1606853.14	226640.41	
R	1188.00			
Δ	2°25'52.01"			
D	4°49'23.00"			
L	50.41			
T	25.21			
CHORD	50.40			
M.O.	0.27			
E	0.27			

ALIGNMENT DATA FOR AL-9				
	STATION	X COORD	Y COORD	
CURVE				
POB	90+00.00	1606446.14	226163.32	
PI	90+34.69	1606478.99	226174.49	
CC		1606655.34	225547.91	
PRC	90+69.32	1606512.84	226182.10	
R	650.00			
Δ	6°06'38.56"			
D	8°48'53.05"			
L	69.32			
T	34.69			
CHORD	69.29			
M.O.	0.92			
E	0.93			
CURVE				
PRC	90+69.32	1606512.84	226182.10	
PI	91+55.04	1606596.47	226200.89	
CC		1606356.74	226876.78	
PRC	92+39.94	1606673.26	226239.00	
R	712.00			
Δ	13°43'48.46"			
D	8°02'49.78"			
L	170.62			
T	85.72			
CHORD	170.21			
M.O.	5.10			
E	5.14			
CURVE				
PRC	92+39.94	1606673.26	226239.00	
PI	92+97.11	1606724.47	226264.41	
CC		1606740.83	226102.84	
PCC	93+49.31	1606779.73	226249.78	
R	152.00			
Δ	41°13'27.69"			
D	37°41'40.53"			
L	109.36			
T	57.17			
CHORD	107.02			
M.O.	9.73			
E	10.40			
CURVE				
PCC	93+49.31	1606779.73	226249.78	
PI	93+61.12	1606791.15	226246.75	
CC		1606774.10	226228.51	
PCC	93+70.99	1606794.94	226235.56	
R	22.00			
Δ	56°28'16.14"			
D	260°26'07.30"			
L	21.68			
T	11.81			
CHORD	20.82			
M.O.	2.62			
E	2.97			
CURVE				
PCC	93+70.99	1606794.94	226235.56	
PI	94+18.12	1606810.05	226190.93	
CC		1606584.66	226164.39	
PT	94+63.86	1606805.72	226144.00	
R	222.00			
Δ	23°58'05.47"			
D	25°48'32.07"			
L	92.87			
T	47.12			
CHORD	92.19			
M.O.	4.84			
E	4.95			
TANGENT				
PT	94+63.86	1606805.72	226144.00	
POE	96+02.08	1606793.03	226006.37	
BEARING	S5°16'10.23"W			
LENGTH	138.22			

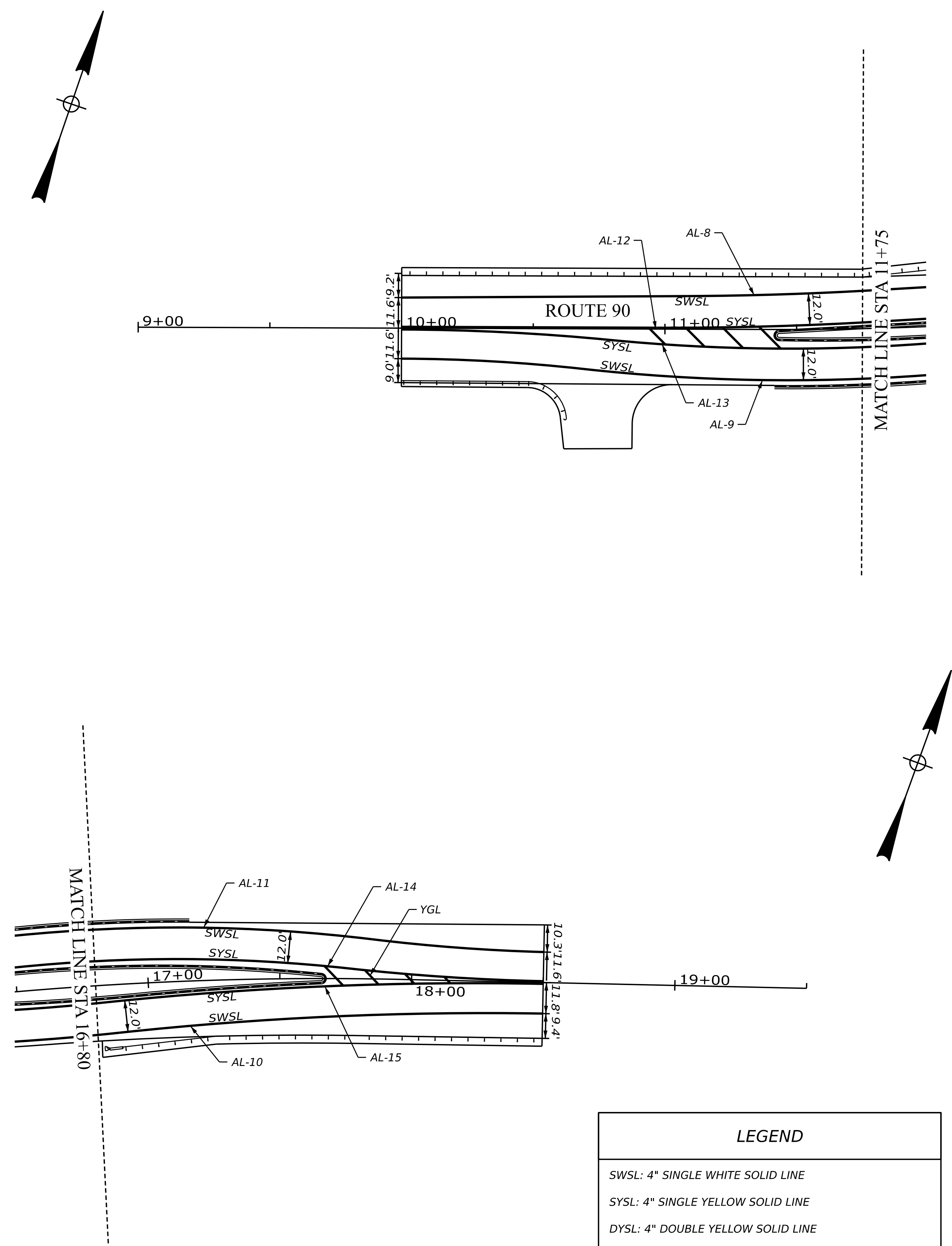
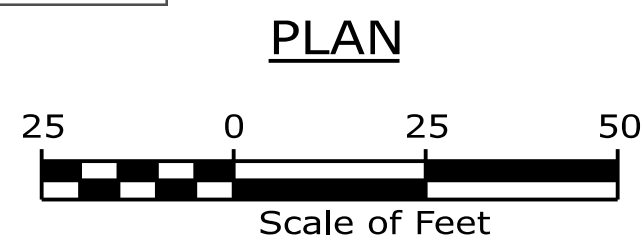

LEGEND	
SWSL:	4" SINGLE WHITE SOLID LINE
SYSL:	4" SINGLE YELLOW SOLID LINE
DYSL:	4" DOUBLE YELLOW SOLID LINE
SWBL:	6" SINGLE WHITE BROKEN LINE 2' LENGTH - 2' GAP
YGL:	12" DIAGONAL YELLOW GORE LINE 10' O.C.

STATE OF MAINE DEPARTMENT OF TRANSPORTATION		HIGHWAY PLANS WIN 27036.00	
PROJ. M-N-GER	BY	D-TE	
DESIGN-DET-LED	CHECKED-REVIEWED	SIGNATURE	
DESIGN-DET-LED	DESIGN-DET-LED	P.E. NUMBER	
DESIGN-DET-LED	DESIGN-DET-LED	DATE	
REVISIONS 1			
REVISIONS 2			
REVISIONS 3			
REVISIONS 4			
FIELD CHANGES			
WARREN ROUTE 90 AT WESTERN RD STRIPING PLANS			
SHEET NUMBER 18 OF 64			

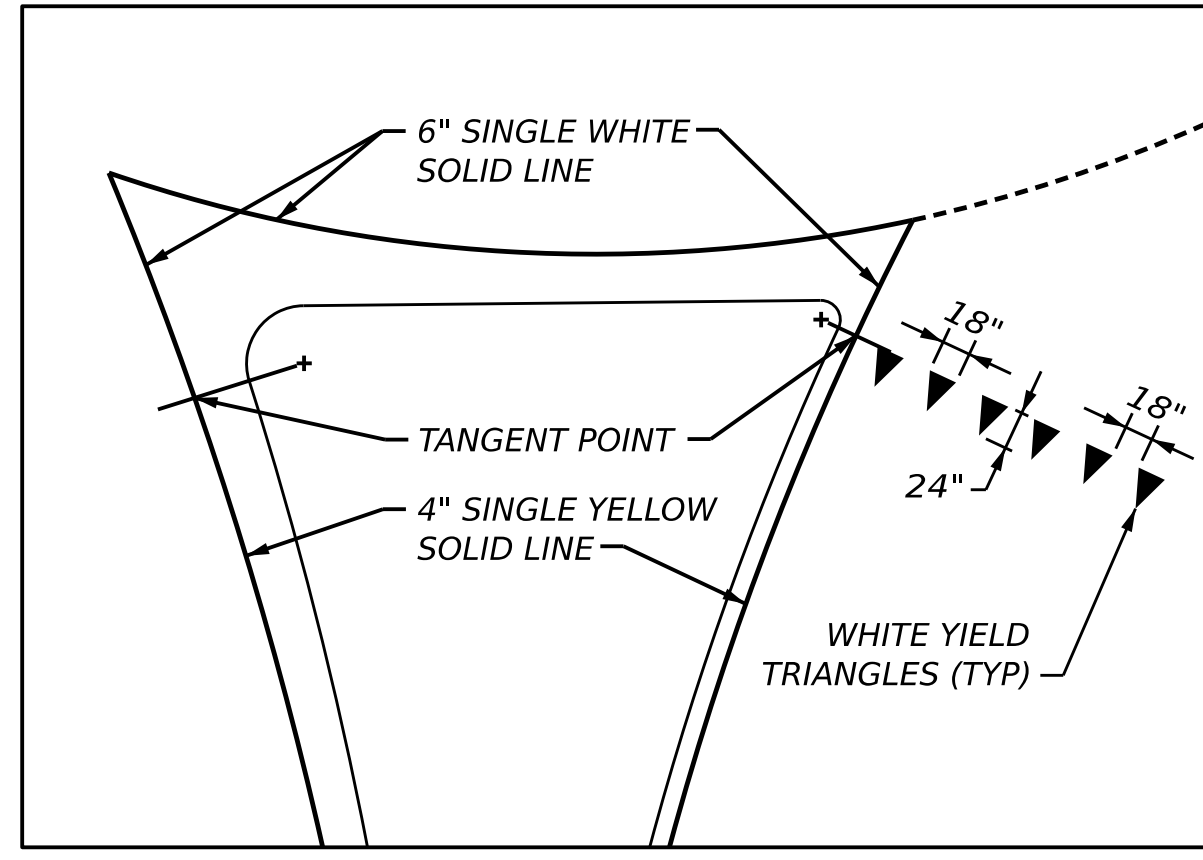

SPLITTER ISLAND NOSE GORE STRIPING DETAIL N.T.S.

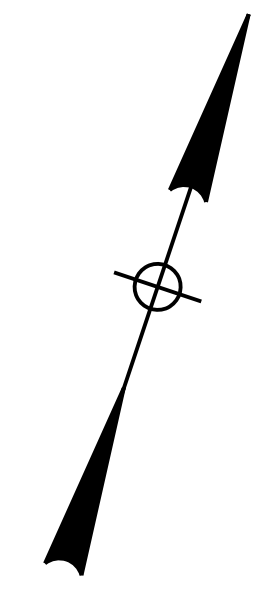
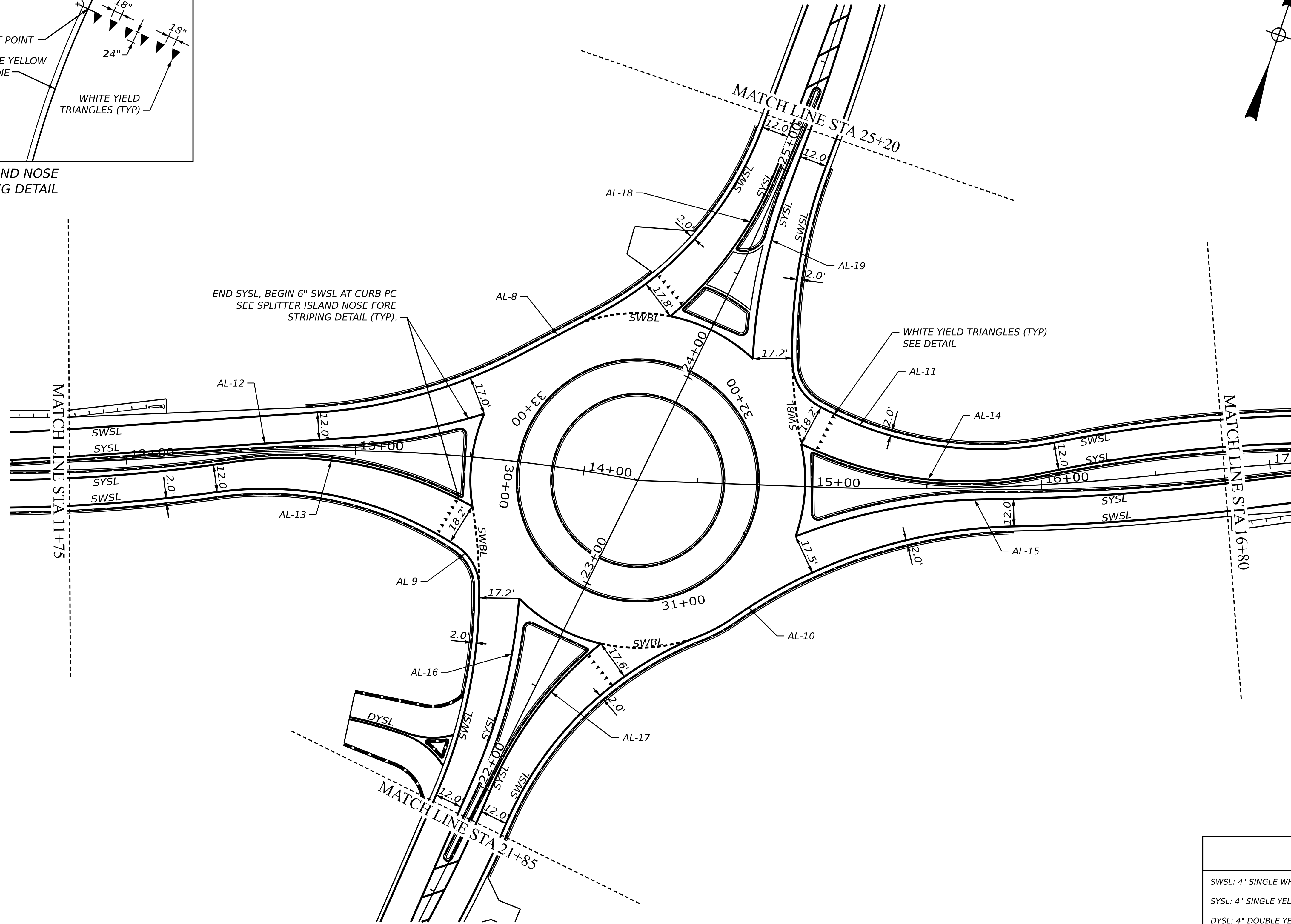

LEGEND	
SWSL:	4" SINGLE WHITE SOLID LINE
SYSL:	4" SINGLE YELLOW SOLID LINE
DYSL:	4" DOUBLE YELLOW SOLID LINE
SWBL:	6" SINGLE WHITE BROKEN LINE 2' LENGTH - 2' GAP
YGL:	12" DIAGONAL YELLOW GORE LINE 10° O.C.

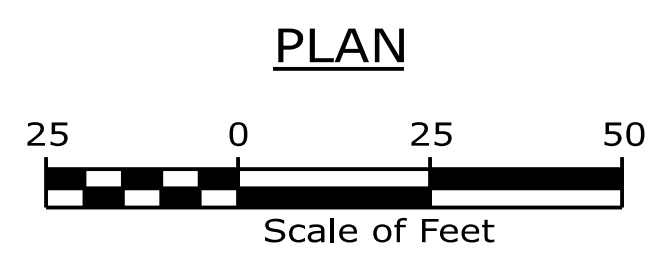

PROJ. M-N-GER	BY	D-TE	SIGNATURE	P.E. NUMBER	DATE
DESIGN-DET-LED					
CHECKED-REVIEWED					
DESIGN-DET-LED					
DESIGN-DET-LED					
REVISIONS 1					
REVISIONS 2					
REVISIONS 3					
REVISIONS 4					
FIELD CHANGES					

WARREN
ROUTE 90 AT WESTERN RD
STRIPING PLANS

ALIGNMENT DATA FOR AL-10				
	STATION	X COORD	Y COORD	
TANGENT				
POB	100+00.00	1606815.09	226003.31	
PC	100+75.54	1606829.56	226077.45	
BEARING	N11°02'41.82"E			
LENGTH	75.54			
CURVE				
PC	100+75.54	1606829.56	226077.45	
PI	101+08.40	1606835.86	226109.70	
CC		1606228.90	226194.69	
PRC	101+41.19	1606838.66	226142.44	
R	612.00			
Δ	6°08'49.41"			
D	9°21'43.40"			
L	65.66			
T	32.86			
CHORD	65.63			
M.O.	0.88			
E	0.88			
CURVE				
PRC	101+41.19	1606838.66	226142.44	
PI	102+04.39	1606844.06	226205.40	
CC		1606990.11	226129.46	
PRC	102+60.98	1606892.50	226245.98	
R	152.00			
Δ	45°09'03.72"			
D	37°41'40.53"			
L	119.78			
T	63.20			
CHORD	116.71			
M.O.	11.65			
E	12.61			
CURVE				
PRC	102+60.98	1606892.50	226245.98	
PI	102+69.56	1606899.08	226251.49	
CC		1606845.63	226301.95	
PRC	102+78.06	1606904.20	226258.38	
R	73.00			
Δ	13°24'21.38"			
D	78°29'14.53"			
L	17.08			
T	8.58			
CHORD	17.04			
M.O.	0.50			
E	0.50			
CURVE				
PRC	102+78.06	1606904.20	226258.38	
PI	103+45.27	1606944.31	226312.30	
CC		1607082.33	226125.88	
PRC	104+08.58	1607007.60	226334.93	
R	222.00			
Δ	33°41'14.35"			
D	25°48'32.07"			
L	130.53			
T	67.21			
CHORD	128.65			
M.O.	9.52			
E	9.95			
CURVE				
PRC	104+08.58	1607007.60	226334.93	
PI	104+59.43	1607055.48	226352.04	
CC		1606700.62	227193.71	
PRC	105+10.17	1607101.16	226374.37	
R	912.00			
Δ	6°22'56.53"			
D	6°16'56.76"			
L	101.59			
T	50.85			
CHORD	101.54			
M.O.	1.41			
E	1.42			
CURVE				
PRC	105+10.17	1607101.16	226374.37	
PI	105+90.67	1607173.48	226409.73	
CC		1607672.11	225206.46	
POE	106+70.97	1607249.61	226435.89	
R	1300.00			
Δ	7°05'12.36"			
D	4°24'26.52"			
L	160.79			
T	80.50			
CHORD	160.69			
M.O.	2.49			
E	2.49			

ALIGNMENT DATA FOR AL-11				
	STATION	X COORD	Y COORD	
TANGENT				
POB	110+00.00	1606873.95	226641.17	
PC	110+95.51	1606879.46	226545.82	
BEARING	S3°18'32.95"E			
LENGTH	95.51			
CURVE				
PC	110+95.51	1606879.46	226545.82	
PI	111+39.49	1606882.00	226501.91	
CC		1606018.90	226496.06	
PRC	111+83.40	1606880.06	226457.97	
R	862.00			
Δ	5°50'30.93"			
D	6°38'48.63"			
L	87.89			
T	43.98			
CHORD	87.85			
M.O.	1.12			
E	1.12			
CURVE				
PRC	111+83.40	1606880.06	226457.97	
PI	112+27.81	1606878.10	226413.61	
CC		1607101.84	226448.16	
PCC	112+71.06	1606893.35	226371.90	
R	222.00			
Δ	22°37'26.30"			
D	25°48'32.07"			
L	87.66			
T	44.41			
CHORD	87.09			
M.O.	4.31			
E	4.40			
CURVE				
PCC	112+71.06	1606893.35	226371.90	
PI	112+83.63	1606897.67	226360.10	
CC		1606914.01	226379.46	
PCC	112+93.90	1606910.03	226357.82	
R	22.00			
Δ	59°28'25.12"			
D	260°26'07.30"			
L	22.84			
T	12.57			
CHORD	21.82			
M.O.	2.90			
E	3.34			
CURVE				
PCC	112+93.90	1606910.03	226357.82	
PI	113+49.50	1606964.71	226347.75	
CC		1606937.56	226507.31	
PRC	114+00.50	1607012.98	226375.34	
R	152.00			
Δ	40°11'05.05"			
D	37°41'40.53"			
L	106.61			
T	55.60			
CHORD	104.43			
M.O.	9.25			
E	9.85			
CURVE				
PRC	114+00.50	1607012.98	226375.34	
PI	114+90.65	1607091.24	226420.07	
CC		1607316.66	225844.00	
PRC	115+79.50	1607179.08	226440.34	
R	612.00			
Δ	16°45'28.68"			
D	9°21'43.40"			
L	179.00			
T	90.14			
CHORD	178.36			
M.O.	6.53			
E	6.60			
CURVE				
PRC	115+79.50	1607179.08	226440.34	
PI	116+12.27	1607211.01	226447.70	
CC		1607021.71	227122.42	
POE	116+44.98	1607242.10	226458.02	
R	700.00			
Δ	5°21'35.11"			
D	8°11'06.40"			
L	65.48			
T	32.76			
CHORD	65.46			
M.O.	0.77			
E	0.77			

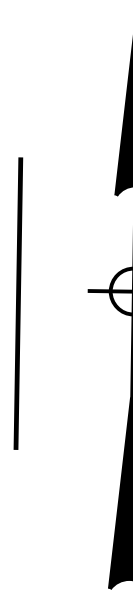
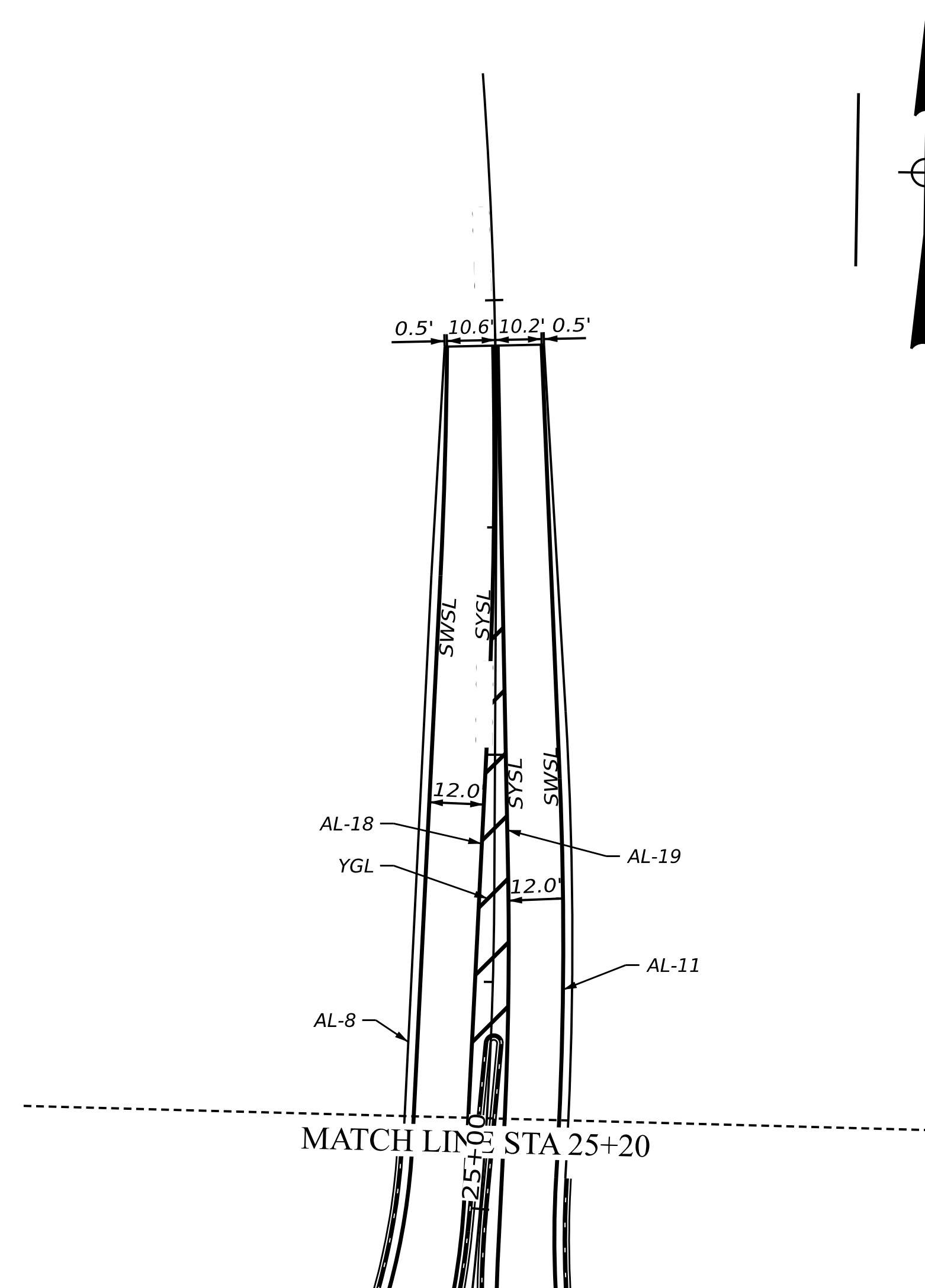
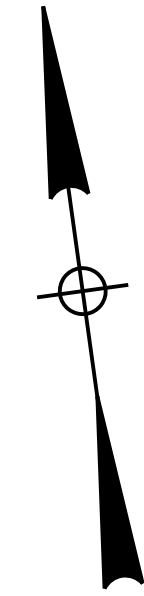
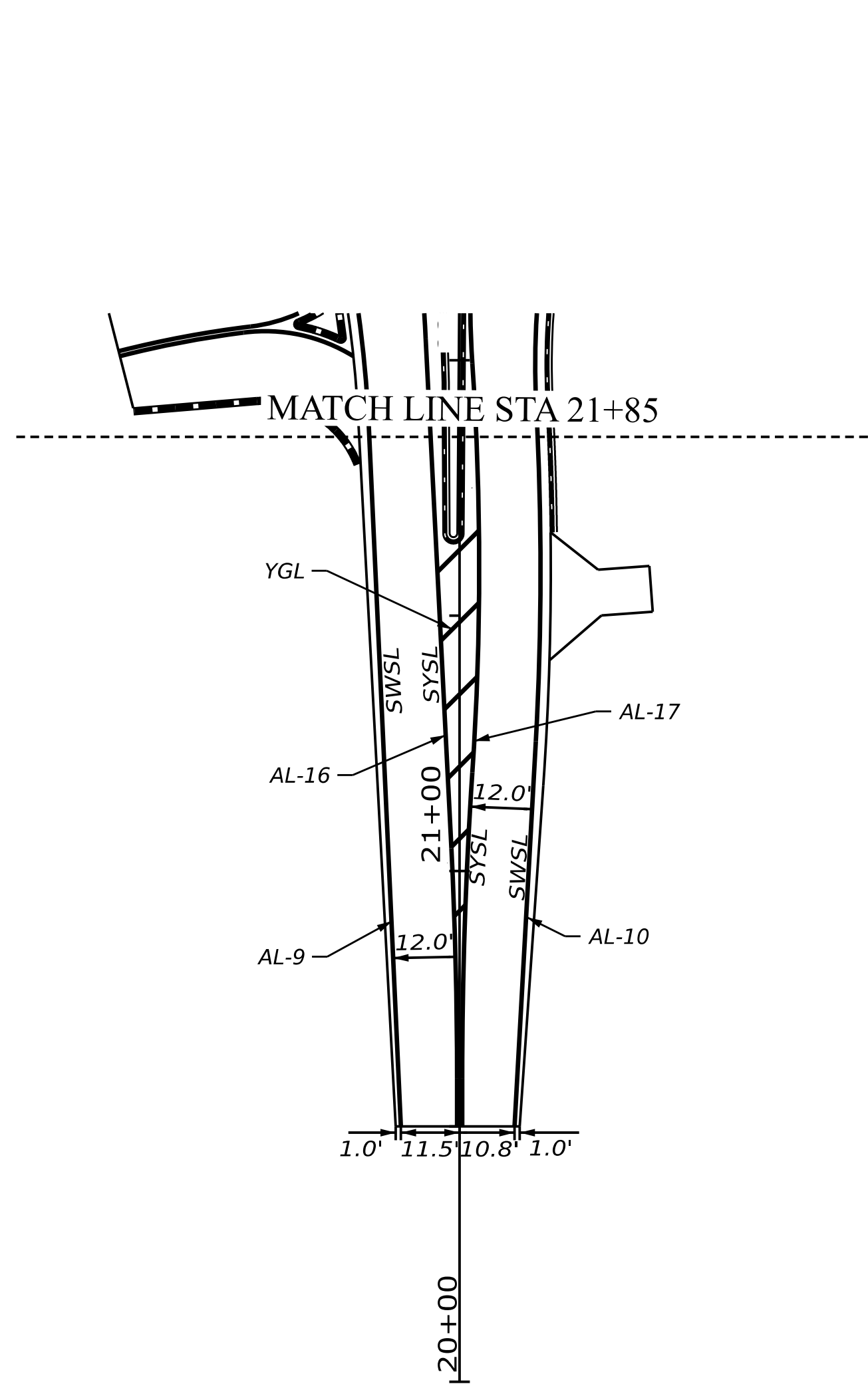

LEGEND	
SWSL:	4" SINGLE WHITE SOLID LINE
SYSL:	4" SINGLE YELLOW SOLID LINE
DYSL:	4" DOUBLE YELLOW SOLID LINE
SWBL:	6" SINGLE WHITE BROKEN LINE 2' LENGTH - 2' GAP
YGL:	12" DIAGONAL YELLOW GORE LINE 10' O.C.

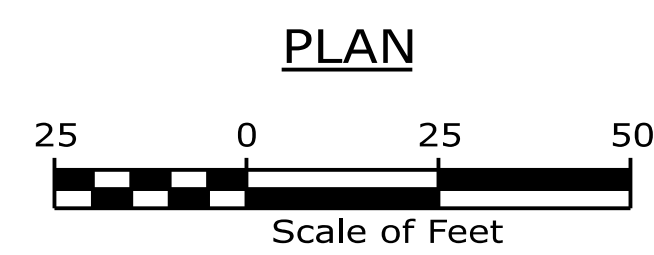

STATE OF MAINE DEPARTMENT OF TRANSPORTATION		WIN 27036.00 HIGHWAY PLANS
	SIGNATURE	P.E. NUMBER
BY	D-TE	DATE
PROJ. M-N-GER	DESIGN-DET-LED	REVISIONS 1
CHECKED-REVISED	DESIGN-DET-LED	REVISIONS 2
DESIGN-DET-LED	DESIGN-DET-LED	REVISIONS 3
REVISIONS 1	REVISIONS 2	REVISIONS 4
REVISIONS 2	REVISIONS 3	FIELD CHANGES
REVISIONS 3	WARREN ROUTE 90 AT WESTERN RD	
REVISIONS 4	STRIPING PLANS	
SHEET NUMBER		
20		
OF 64		

ALIGNMENT DATA FOR AL-12. Table with columns: STATION, X COORD, Y COORD. Includes TANGENT, CURVE, and TANGENT data points.

ALIGNMENT DATA FOR AL-13. Table with columns: STATION, X COORD, Y COORD. Includes TANGENT, CURVE, and TANGENT data points.

ALIGNMENT DATA FOR AL-14. Table with columns: STATION, X COORD, Y COORD. Includes TANGENT, CURVE, and TANGENT data points.

ALIGNMENT DATA FOR AL-15. Table with columns: STATION, X COORD, Y COORD. Includes TANGENT, CURVE, and TANGENT data points.

ALIGNMENT DATA FOR AL-16. Table with columns: STATION, X COORD, Y COORD. Includes TANGENT, CURVE, and TANGENT data points.

ALIGNMENT DATA FOR AL-17. Table with columns: STATION, X COORD, Y COORD. Includes TANGENT, CURVE, and TANGENT data points.

ALIGNMENT DATA FOR AL-18. Table with columns: STATION, X COORD, Y COORD. Includes TANGENT, CURVE, and TANGENT data points.

ALIGNMENT DATA FOR AL-19. Table with columns: STATION, X COORD, Y COORD. Includes TANGENT, CURVE, and TANGENT data points.

Project title block containing: STATE OF MAINE DEPARTMENT OF TRANSPORTATION, WARREN ROUTE 90 AT WESTERN RD, STRIPING PLANS, SHEET NUMBER 21 OF 64, and signature lines for SIGNATURE, P.E. NUMBER, and DATE.

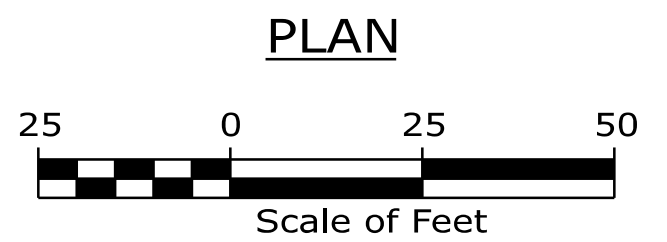
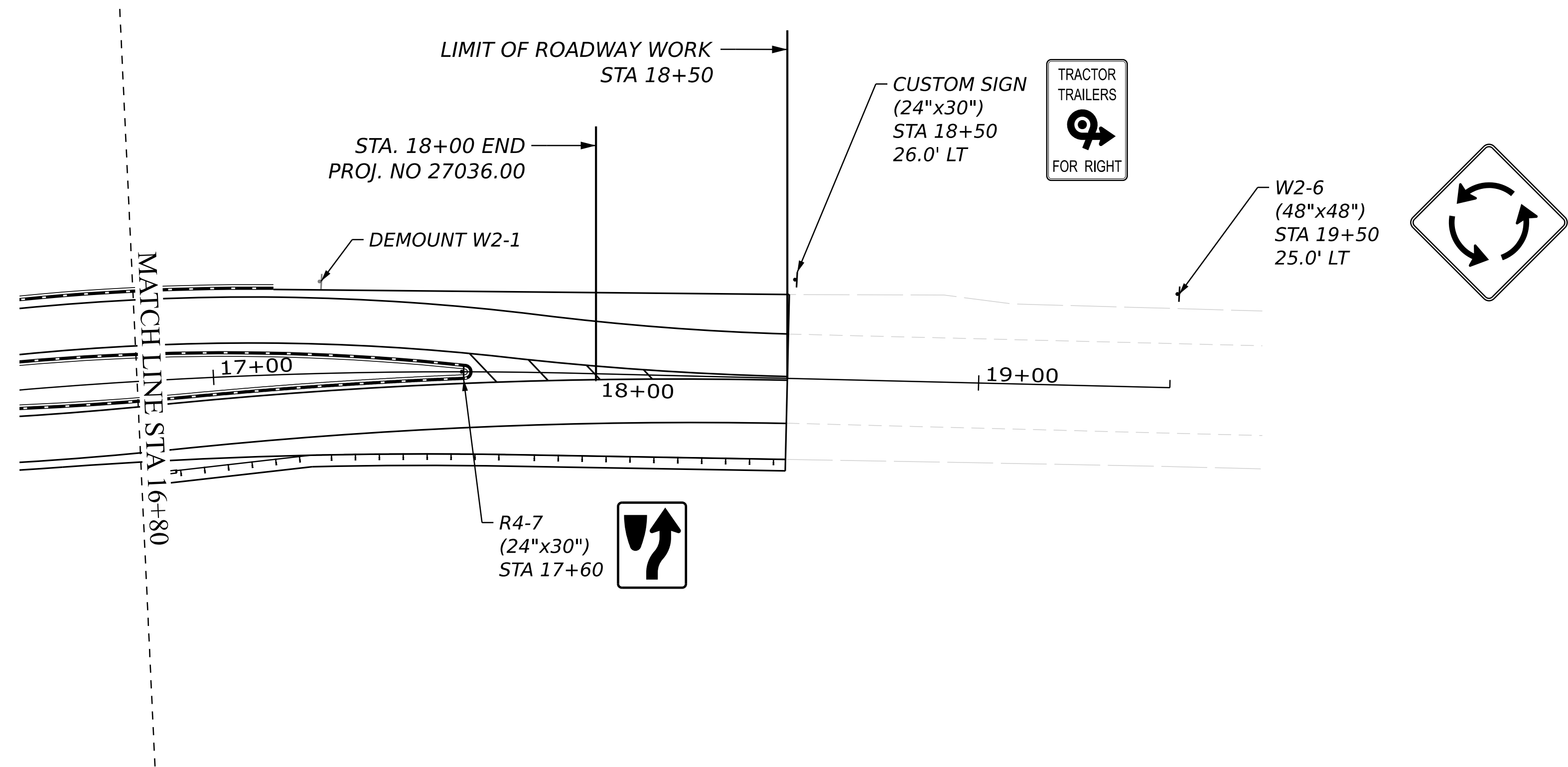
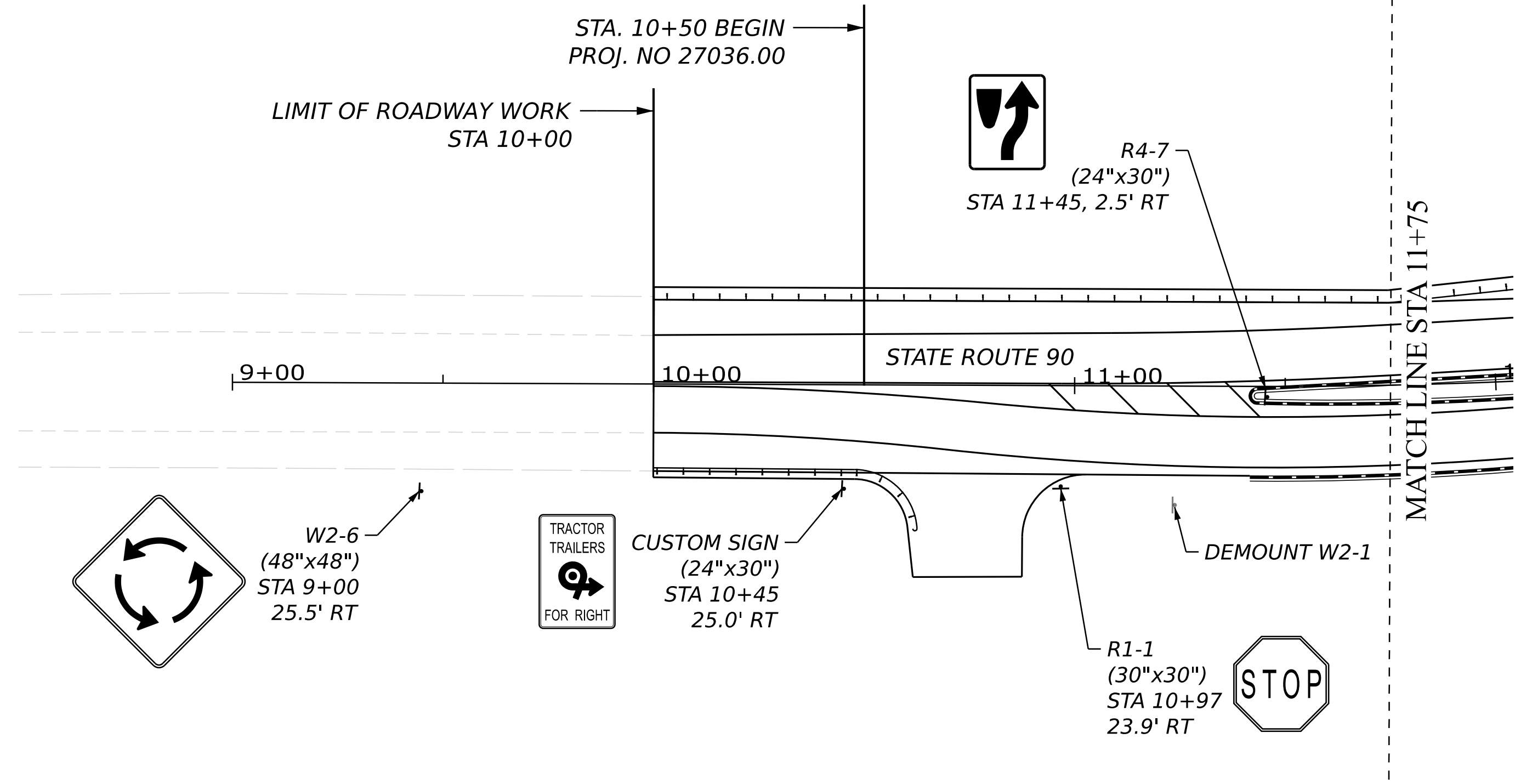

STATE OF MAINE
DEPARTMENT OF TRANSPORTATION

WARREN
ROUTE 90 AT WESTERN RD
SIGNING PLANS

SHEET NUMBER

22

OF 64

PROJ. MANAGER	BY	DATE	SIGNATURE	P.E. NUMBER	DATE
DESIGN-DETAILED					
CHECKED-REVIEWED					
DESIGN-DETAILED					
DESIGN-DETAILED					
REVISIONS 1					
REVISIONS 2					
REVISIONS 3					
REVISIONS 4					
FIELD CHANGES					

WIN
27036.00
HIGHWAY PLANS

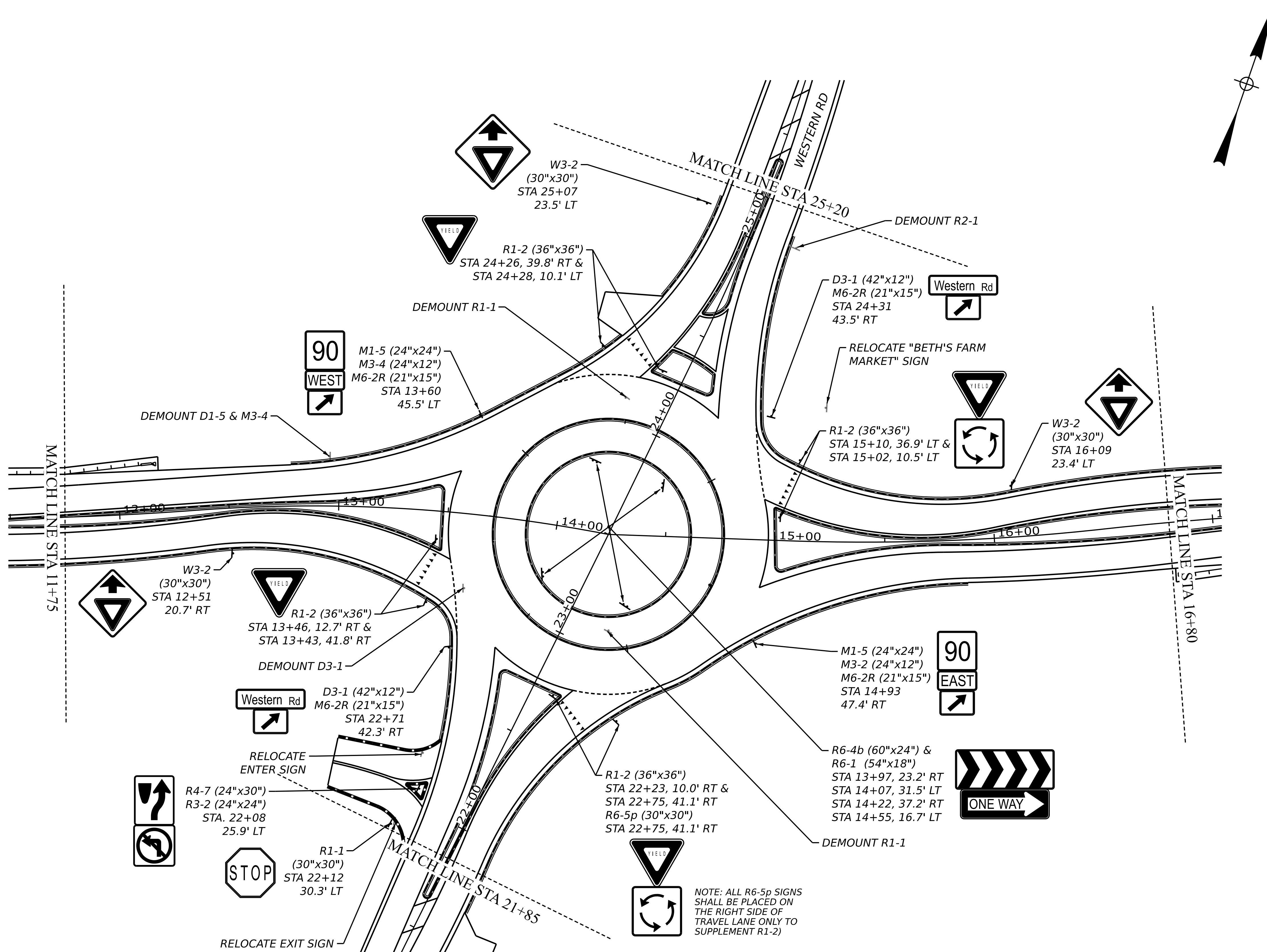

NOTE: ALL R6-5p SIGNS SHALL BE PLACED ON THE RIGHT SIDE OF TRAVEL LANE ONLY TO SUPPLEMENT R1-2)

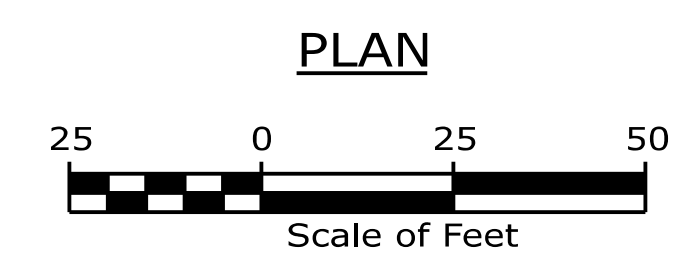

PROJ. MANAGER	DATE	BY	DATE	SIGNATURE	P.E. NUMBER	DATE
DESIGN-DETAILED						
CHECKED-REVIEWED						
DESIGN-DETAILED						
REVISIONS 1						
REVISIONS 2						
REVISIONS 3						
REVISIONS 4						
FIELD CHANGES						

WARREN
 ROUTE 90 AT WESTERN RD
 SIGNING PLANS

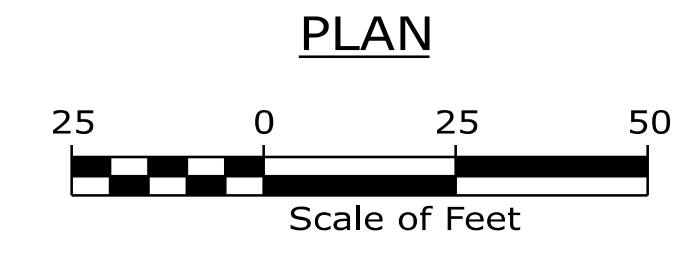
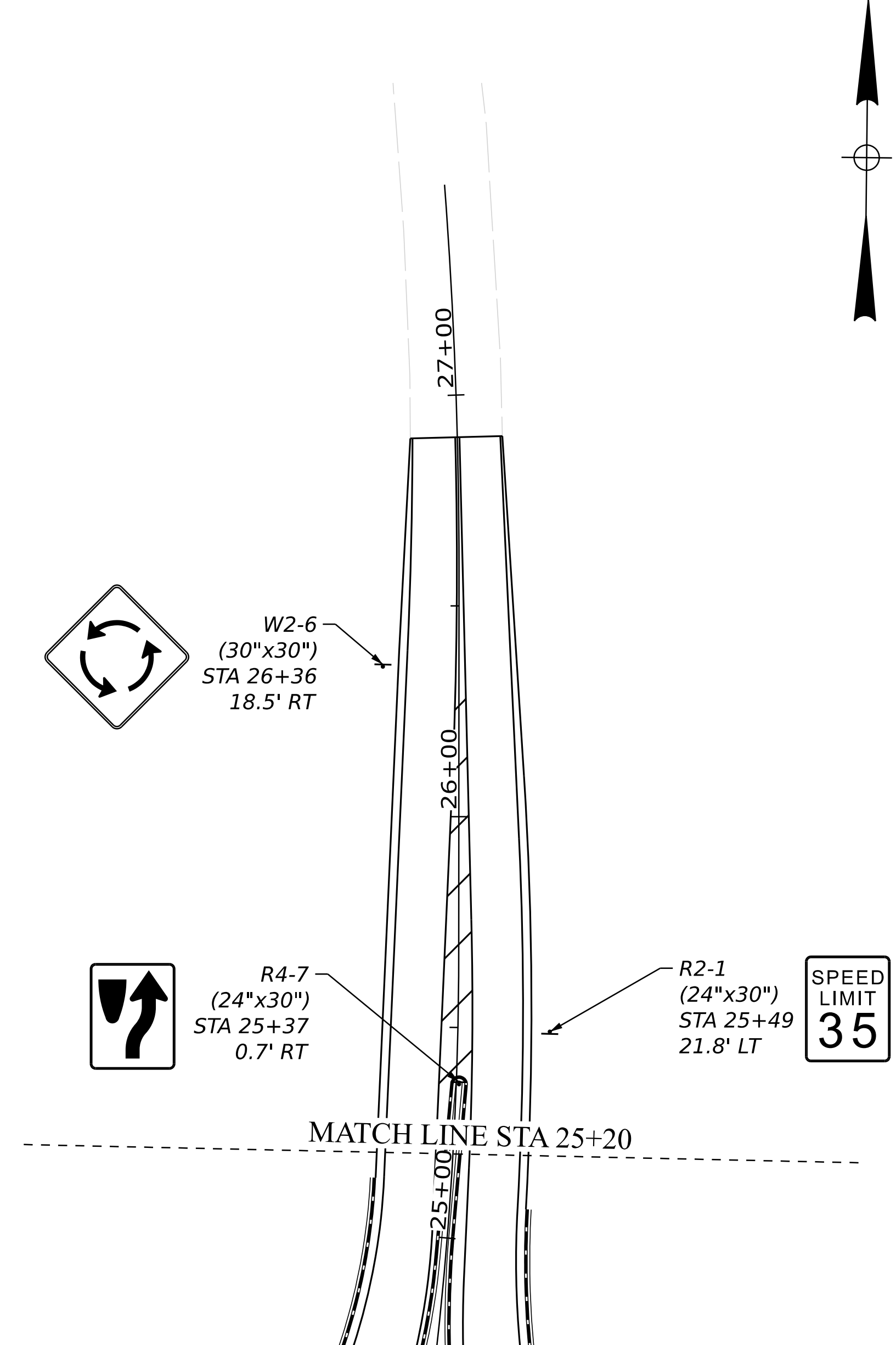
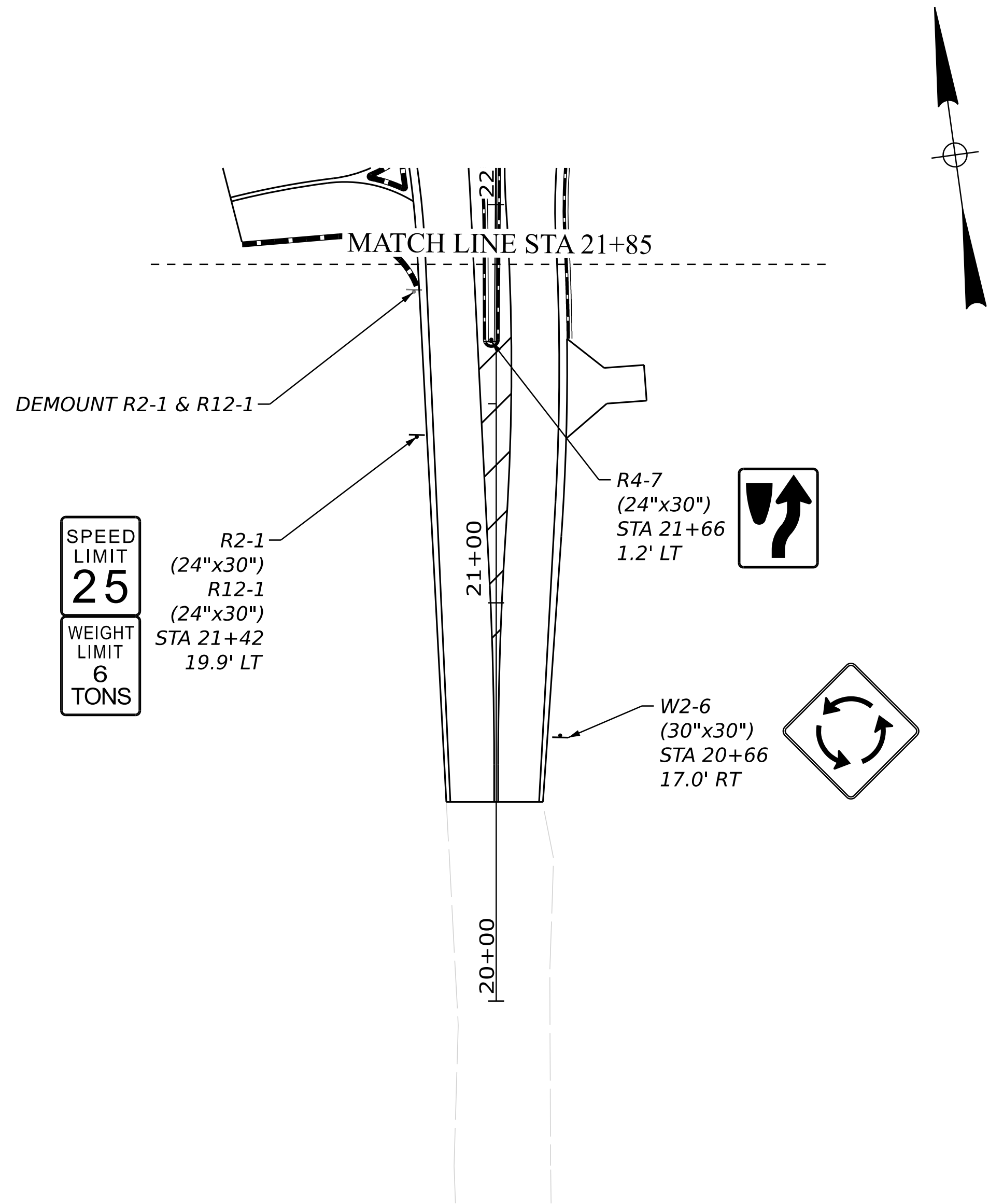

PROJ. MANAGER	BY	DATE	SIGNATURE
DESIGN-DETAILED			
CHECKED-REVIEWED			
DESIGN-DETAILED			
DESIGN-DETAILED			
REVISIONS 1			
REVISIONS 2			
REVISIONS 3			
REVISIONS 4			
FIELD CHANGES			
			P.E. NUMBER
			DATE

WARREN
ROUTE 90 AT WESTERN RD
SIGNING PLANS

SIGN SUMMARY

MUTCD NUMBER	SIZE OF SIGN (IN)		GRAPHIC	NUMBER OF SIGNS REQUIRED	COLOR		TOTAL AREA IN SQ. FT.	TYPE	SUPPORT	REMARK
	WIDTH	HEIGHT			BACK-GROUND	LEGEND BORDER				
R1-1	30	30		2	RED	WHITE	12.50	II	U-CHANNEL	-
R1-2	36	36		4	RED	WHITE	36.00	II	U-CHANNEL	-
R2-1	24	30		2	WHITE	BLACK	10.00	II (ALUM)	U-CHANNEL	-
R4-7	24	30		4	WHITE	BLACK	20.00	II (ALUM)	U-CHANNEL	-
R6-1	54	18		4	BLACK	BLACK/WHITE	27	II	2 - 4"x6" WOOD POST	-
R6-4	60	24		4	WHITE	BLACK	20.00	II	-	MOUNTED WITH R6-1
R12-1	24	30		1	WHITE	BLACK	5.00	II (ALUM)	U-CHANNEL	-
M1-5	24	24		2	WHITE	BLACK	8.00	II	ROUTE ASSEMBLY	SEE DETAILS
M3-2	24	12		1	WHITE	BLACK	2.00	II	ROUTE ASSEMBLY	SEE DETAILS
M3-4	24	12		1	WHITE	BLACK	2.00	II	ROUTE ASSEMBLY	SEE DETAILS
M6-2R	21	15		4	WHITE	BLACK	8.75	II	ROUTE ASSEMBLY	SEE DETAILS

SIGN SUMMARY

MUTCD NUMBER	SIZE OF SIGN (IN)		GRAPHIC	NUMBER OF SIGNS REQUIRED	COLOR		TOTAL AREA IN SQ. FT.	TYPE	SUPPORT	REMARK
	WIDTH	HEIGHT			BACK-GROUND	LEGEND BORDER				
W2-6	48	48		4	YELLOW	BLACK	64.00	II	4"x4" WOOD POST	-
W3-2	30	30		4	YELLOW	BLACK	25.00	II	4"x4" WOOD POST	-
D3-1	54	12		2	GREEN	WHITE	9.00	II	ROUTE ASSEMBLY	SEE DETAILS
CUSTOM	24	30		2	WHITE	BLACK	10.00	II	U-CHANNEL	-

ROUTE SIGN ASSEMBLY DETAILS

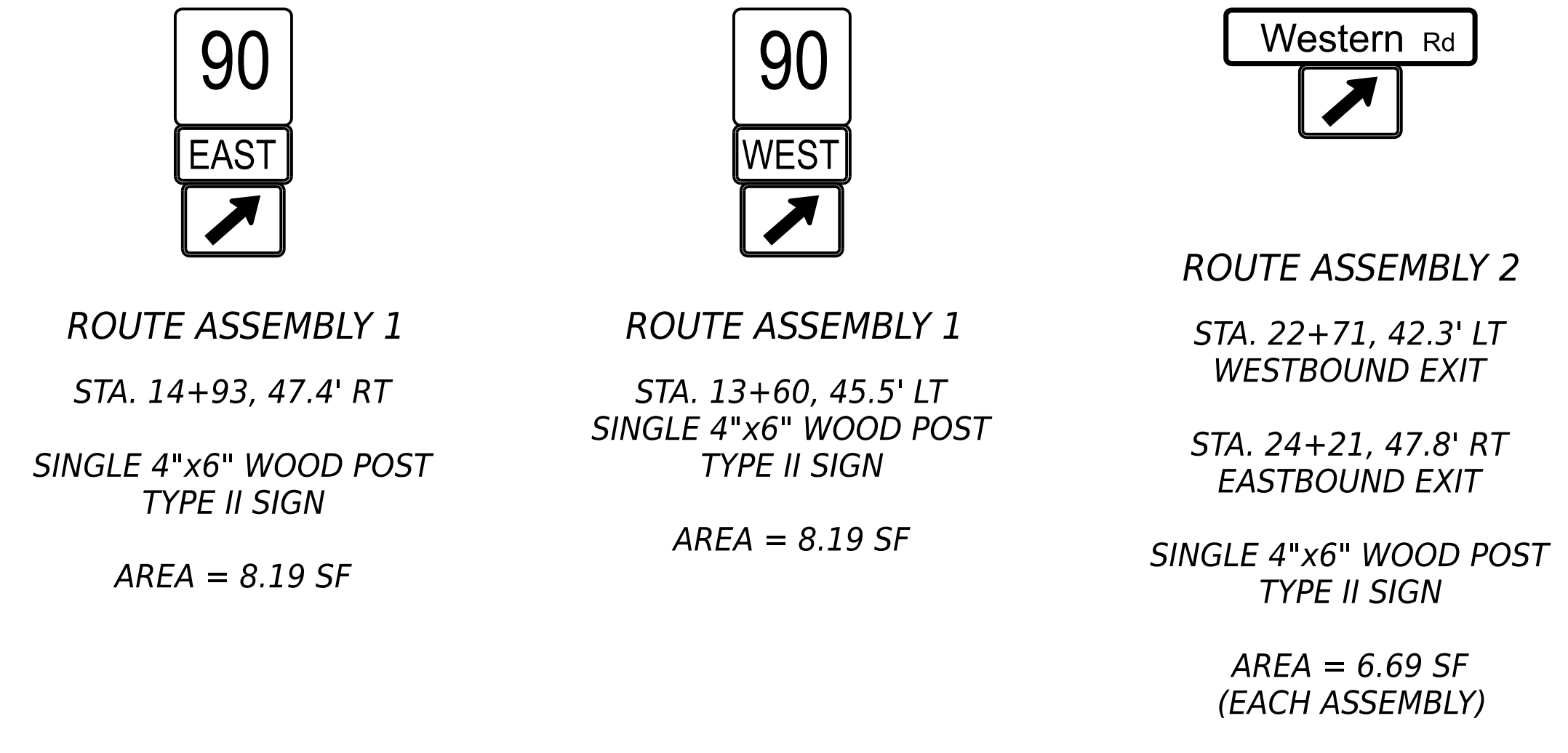

PROJ. MANAGER	DATE	BY	DATE	SIGNATURE	P.E. NUMBER	DATE
DESIGN-DETAILED						
CHECKED-REVIEWED						
DESIGN-DETAILED						
DESIGN-DETAILED						
REVISIONS 1						
REVISIONS 2						
REVISIONS 3						
REVISIONS 4						
FIELD CHANGES						

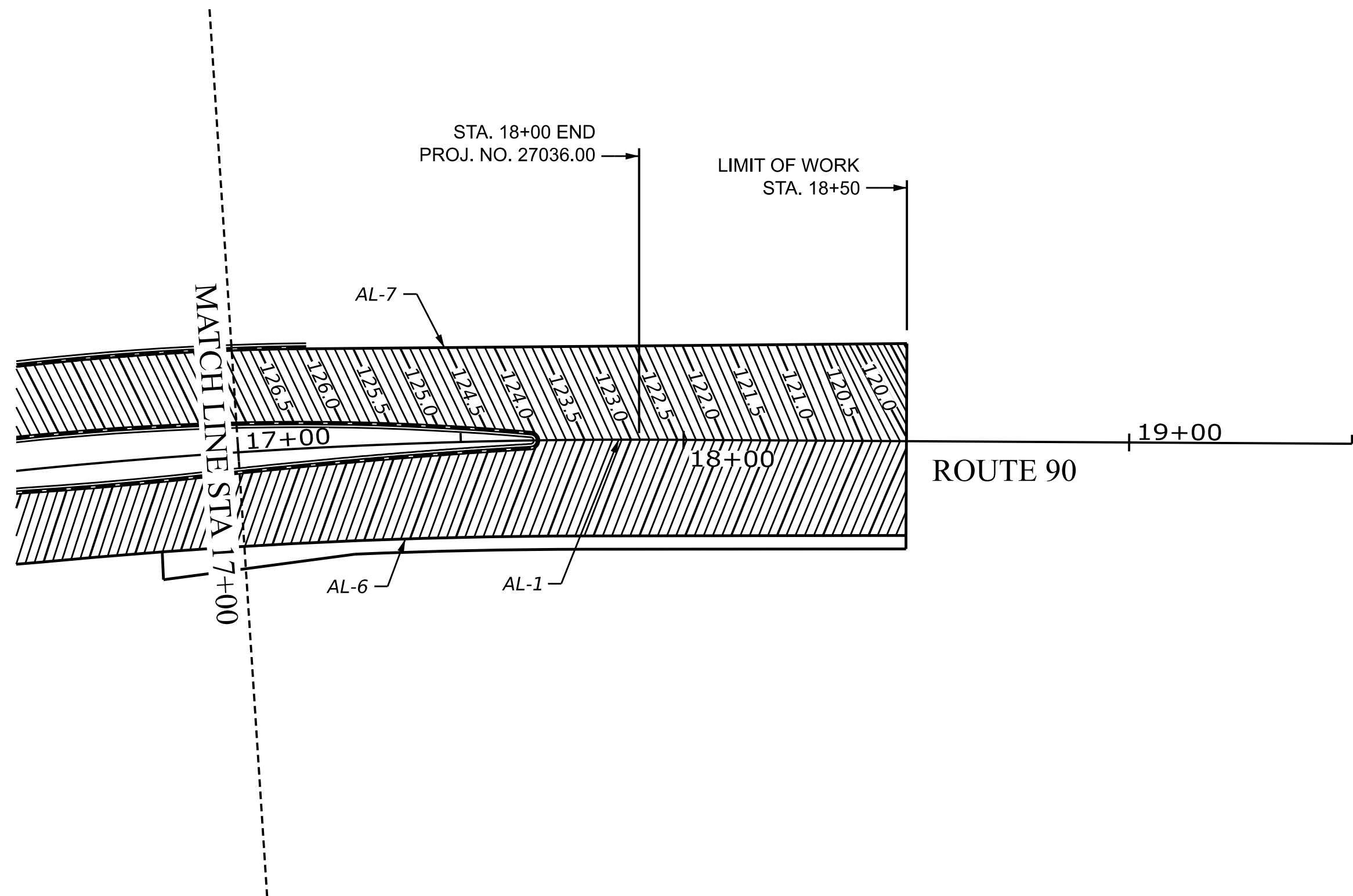
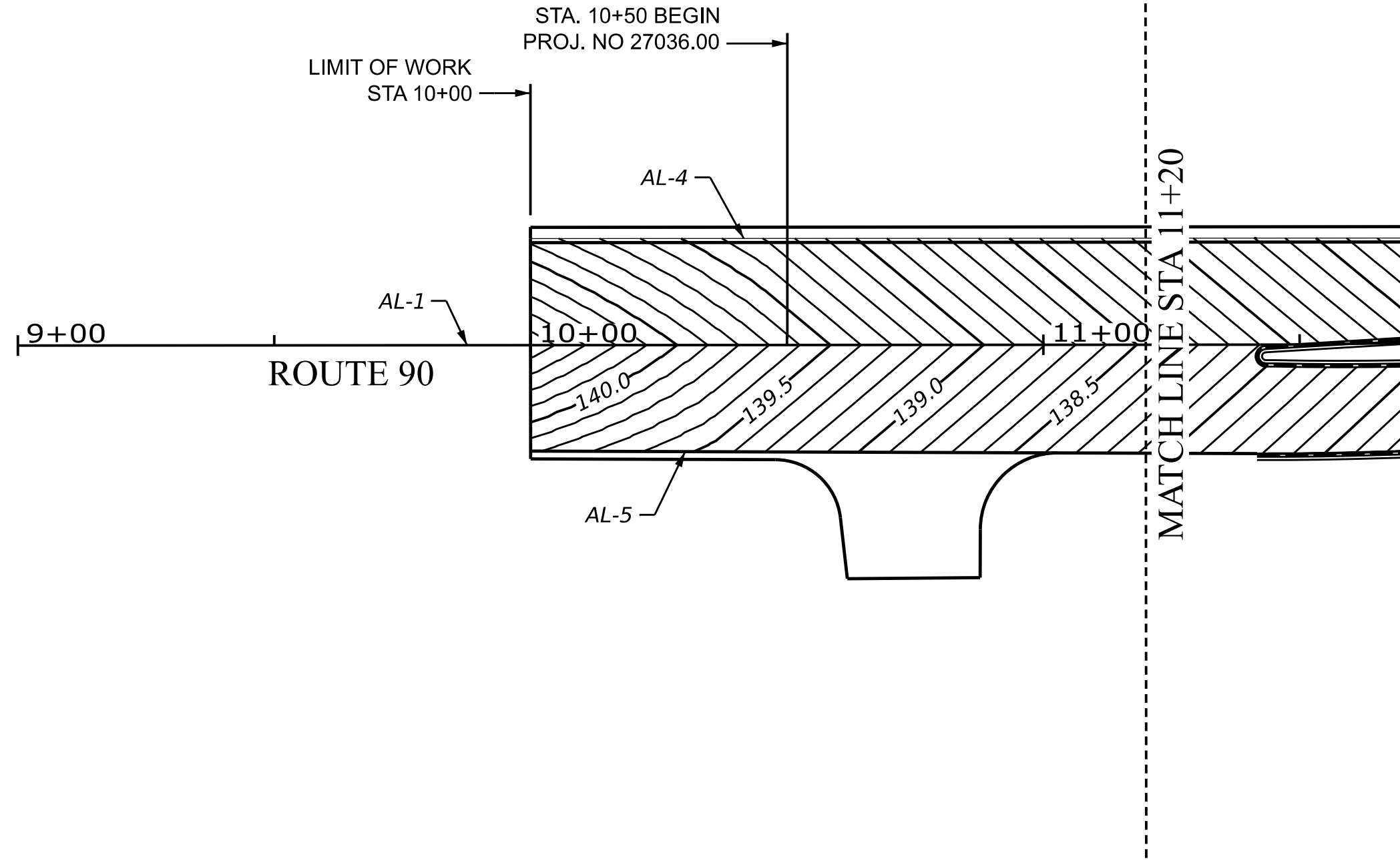
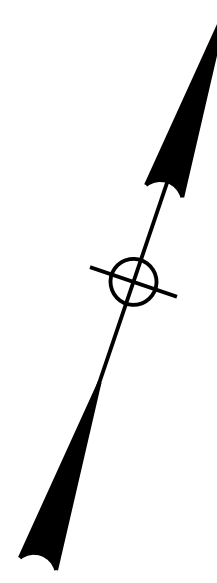

ELEVATIONS FOR AL-4			
STATION	ELEVATION	STATION	ELEVATION
40+00.00	139.87	43+60.00	136.09
40+10.00	139.74	43+70.00	136.10
40+20.00	139.62	43+80.00	136.07
40+30.00	139.49	43+90.00	136.00
40+40.00	139.37	44+00.00	135.91
40+50.00	139.23	44+10.00	135.77
40+60.00	139.06	44+20.00	135.60
40+70.00	138.89	44+30.00	135.41
40+80.00	138.72	44+40.00	135.22
40+90.00	138.56	44+50.00	135.02
41+00.00	138.39	44+60.00	134.83
41+10.00	138.22	44+70.00	134.64
41+20.00	138.06	44+80.00	134.45
41+30.00	137.89	44+90.00	134.31
41+40.00	137.72	45+00.00	134.23
41+50.00	137.55	45+10.00	134.21
41+60.00	137.39	45+20.00	134.24
41+70.00	137.22	45+30.00	134.33
41+80.00	137.05	45+40.00	134.43
41+90.00	136.88	45+50.00	134.51
42+00.00	136.72	45+60.00	134.59
42+10.00	136.55	45+70.00	134.64
42+20.00	136.38	45+80.00	134.67
42+30.00	136.22	45+90.00	134.68
42+40.00	136.05	46+00.00	134.68
42+50.00	135.88	46+10.00	134.66
42+60.00	135.73	46+20.00	134.61
42+70.00	135.64	46+30.00	134.55
42+80.00	135.59	46+40.00	134.47
42+90.00	135.59	46+50.00	134.38
43+00.00	135.65	46+60.00	134.28
43+10.00	135.73	46+70.00	134.19
43+20.00	135.81	46+80.00	134.10
43+30.00	135.90	46+90.00	134.00
43+40.00	135.98	46+97.95	133.93
43+50.00	136.05		

ELEVATIONS FOR AL-5			
STATION	ELEVATION	STATION	ELEVATION
50+00.00	139.82	53+20.00	135.82
50+10.00	139.72	53+30.00	135.91
50+20.00	139.62	53+40.00	136.00
50+30.00	139.52	53+50.00	136.05
50+40.00	139.39	53+60.00	135.99
50+50.00	139.23	53+70.00	135.84
50+60.00	139.06	53+80.00	135.65
50+70.00	138.90	53+90.00	135.45
50+80.00	138.73	54+00.00	135.25
50+90.00	138.57	54+10.00	135.08
51+00.00	138.40	54+20.00	134.99
51+10.00	138.24	54+30.00	134.99
51+20.00	138.08	54+40.00	135.07
51+30.00	137.91	54+50.00	135.24
51+40.00	137.75	54+60.00	135.50
51+50.00	137.58	54+70.00	135.81
51+60.00	137.42	54+80.00	136.13
51+70.00	137.25	54+90.00	136.42
51+80.00	137.09	55+00.00	136.67
51+90.00	136.92	55+10.00	136.90
52+00.00	136.76	55+20.00	137.09
52+10.00	136.59	55+30.00	137.25
52+20.00	136.43	55+40.00	137.41
52+30.00	136.26	55+50.00	137.57
52+40.00	136.10	55+60.00	137.73
52+50.00	135.93	55+70.00	137.89
52+60.00	135.77	55+80.00	138.04
52+70.00	135.66	55+90.00	138.12
52+80.00	135.60	55+97.79	138.12
52+90.00	135.59		
53+00.00	135.64		
53+10.00	135.72		

ELEVATIONS FOR AL-6			
STATION	ELEVATION	STATION	ELEVATION
60+00.00	137.95	63+40.00	133.95
60+10.00	137.90	63+50.00	133.72
60+20.00	137.85	63+60.00	133.47
60+30.00	137.80	63+70.00	133.19
60+40.00	137.69	63+80.00	132.90
60+50.00	137.53	63+90.00	132.58
60+60.00	137.37	64+00.00	132.23
60+70.00	137.21	64+10.00	131.87
60+80.00	137.05	64+20.00	131.48
60+90.00	136.86	64+30.00	131.07
61+00.00	136.64	64+40.00	130.64
61+10.00	136.38	64+50.00	130.19
61+20.00	136.09	64+60.00	129.71
61+30.00	135.78	64+70.00	129.23
61+40.00	135.48	64+80.00	128.74
61+50.00	135.18	64+90.00	128.26
61+60.00	134.95	65+00.00	127.77
61+70.00	134.82	65+10.00	127.28
61+80.00	134.79	65+20.00	126.80
61+90.00	134.85	65+30.00	126.31
62+00.00	134.93	65+40.00	125.83
62+10.00	135.00	65+50.00	125.34
62+20.00	135.06	65+60.00	124.86
62+30.00	135.09	65+70.00	124.37
62+40.00	135.10	65+80.00	123.89
62+50.00	135.08	65+90.00	123.40
62+60.00	135.04	66+00.00	122.92
62+70.00	134.98	66+10.00	122.43
62+80.00	134.90	66+20.00	121.94
62+90.00	134.79	66+30.00	121.46
63+00.00	134.66	66+40.00	120.97
63+10.00	134.51	66+50.00	120.49
63+20.00	134.35	66+60.00	120.00
63+30.00	134.16	66+68.38	119.59

ELEVATIONS FOR AL-7			
STATION	ELEVATION	STATION	ELEVATION
70+00.00	134.12	73+30.00	133.67
70+10.00	134.17	73+40.00	133.39
70+20.00	134.22	73+50.00	133.07
70+30.00	134.27	73+60.00	132.73
70+40.00	134.33	73+70.00	132.35
70+50.00	134.38	73+80.00	131.94
70+60.00	134.45	73+90.00	131.50
70+70.00	134.53	74+00.00	131.04
70+80.00	134.61	74+10.00	130.56
70+90.00	134.66	74+20.00	130.09
71+00.00	134.69	74+30.00	129.61
71+10.00	134.70	74+40.00	129.14
71+20.00	134.69	74+50.00	128.67
71+30.00	134.66	74+60.00	128.19
71+40.00	134.60	74+70.00	127.72
71+50.00	134.53	74+80.00	127.25
71+60.00	134.43	74+90.00	126.77
71+70.00	134.34	75+00.00	126.30
71+80.00	134.28	75+10.00	125.82
71+90.00	134.23	75+20.00	125.35
72+00.00	134.21	75+30.00	124.88
72+10.00	134.21	75+40.00	124.40
72+20.00	134.24	75+50.00	123.93
72+30.00	134.29	75+60.00	123.46
72+40.00	134.36	75+70.00	122.98
72+50.00	134.44	75+80.00	122.51
72+60.00	134.53	75+90.00	122.03
72+70.00	134.60	76+00.00	121.56
72+80.00	134.60	76+10.00	121.09
72+90.00	134.51	76+20.00	120.61
73+00.00	134.35	76+30.00	119.98
73+10.00	134.15	76+40.00	119.33
73+20.00	133.93	76+41.10	119.26

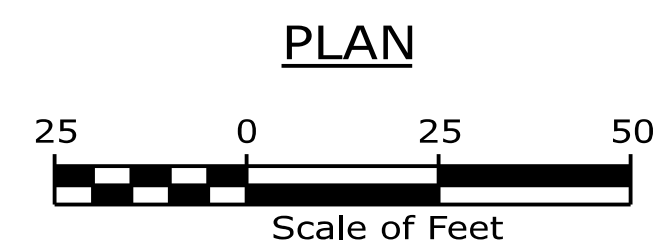

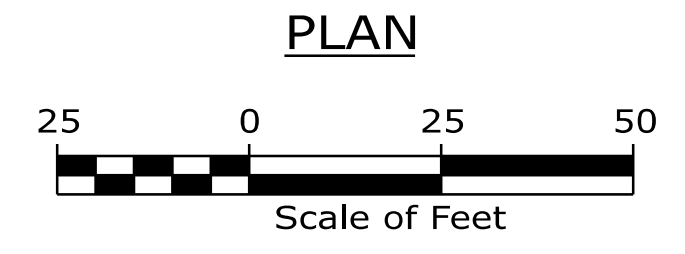
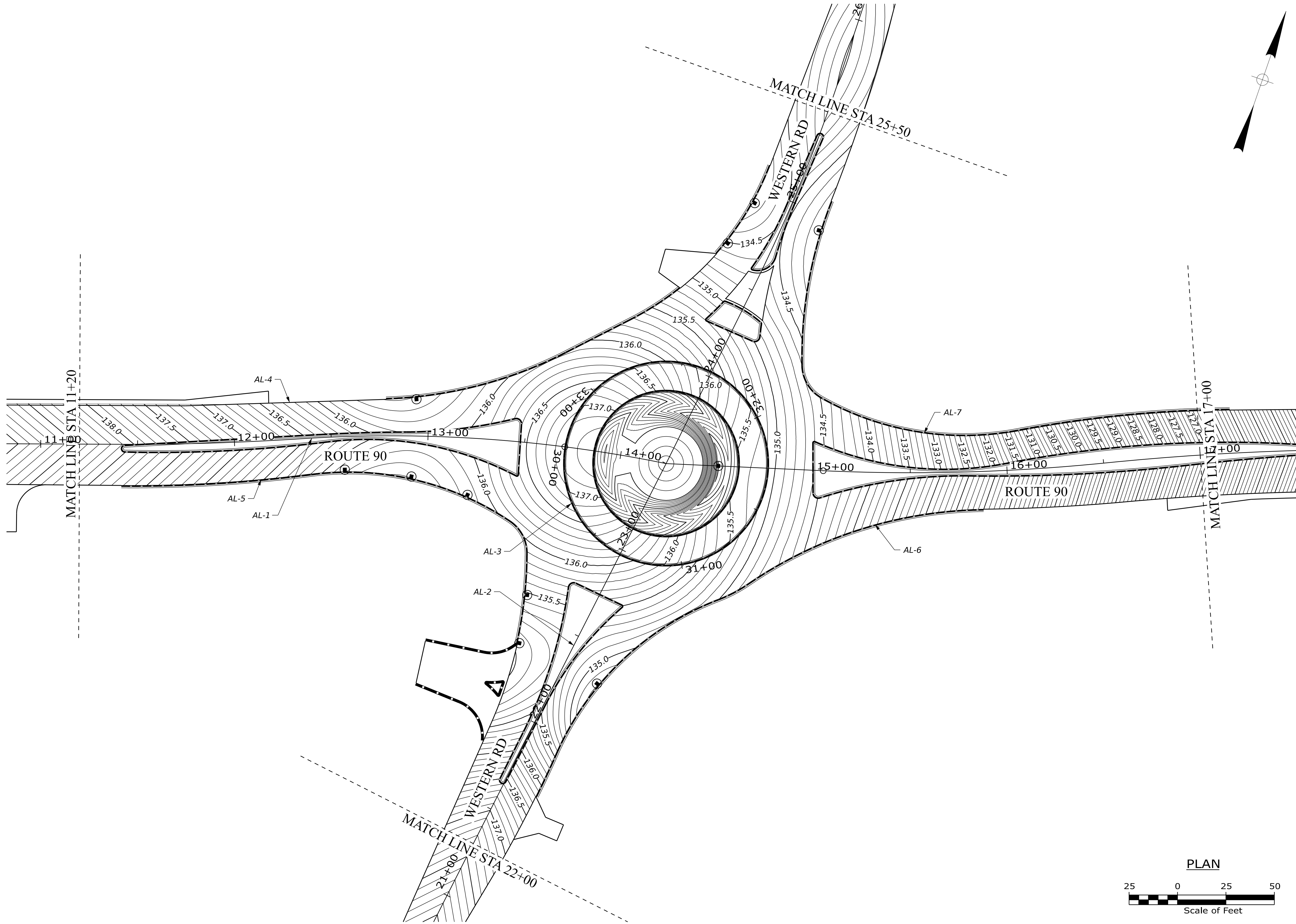

STATE OF MAINE
DEPARTMENT OF TRANSPORTATION

PROJ. MANAGER	BY	DATE
DESIGN-DETAILED	X	X
CHECKED-REVIEWED	X	X
DESIGN-DET FILED 02	X	X
DESIGN-DET FILED 03	X	X
REVISIONS 1		
REVISIONS 2		
REVISIONS 3		
REVISIONS 4		
FIELD CHANGES		

WARREN
ROUTE 90 AT WESTERN RD
GRADING PLANS

SHEET NUMBER
27
OF 64

WIN
27036.00
HIGHWAY PLANS

SIGNATURE
P.E. NUMBER
DATE

ALIGNMENT DATA FOR AL-4				
		STATION	X COORD	Y COORD
TANGENT				
POB		40+00.00	1606435.73	226193.99
PI		41+96.05	1606621.38	226257.00
BEARING	N71°15'13.07"E			
LENGTH	196.05			
TANGENT				
PI		41+96.05	1606621.38	226257.00
PC		42+78.20	1606698.15	226286.23
BEARING	N69°09'15.37"E			
LENGTH	82.15			
CURVE				
PC		42+78.20	1606698.15	226286.23
PI		43+35.28	1606751.49	226306.54
CC			1606619.86	226491.83
PRC		43+89.89	1606788.23	226350.22
R	220.00			
Δ	29°05'14.87"			
D	26°02'36.73"			
L	111.69			
T	57.08			
CHORD	110.49			
M.O.	7.05			
E	7.28			
CURVE				
PRC		43+89.89	1606788.23	226350.22
PI		43+95.39	1606791.77	226354.43
CC			1606845.63	226301.95
PRC		44+00.88	1606795.89	226358.08
R	75.00			
Δ	8°23'34.99"			
D	76°23'39.74"			
L	10.99			
T	5.50			
CHORD	10.98			
M.O.	0.20			
E	0.20			
CURVE				
PRC		44+00.88	1606795.89	226358.08
PI		44+65.38	1606844.17	226400.86
CC			1606696.42	226470.36
PT		45+22.72	1606846.33	226465.33
R	150.00			
Δ	46°32'23.56"			
D	38°11'49.87"			
L	121.84			
T	64.51			
CHORD	118.52			
M.O.	12.20			
E	13.28			
TANGENT				
PT		45+22.72	1606846.33	226465.33
PI		46+47.53	1606850.52	226590.08
BEARING	N1°55'11.92"E			
LENGTH	124.82			
TANGENT				
PI		46+47.53	1606850.52	226590.08
POE		46+97.89	1606852.62	226640.39
BEARING	N2°23'53.51"E			
LENGTH	50.36			

ALIGNMENT DATA FOR AL-5				
		STATION	X COORD	Y COORD
TANGENT				
PT		50+00.00	1606449.05	226154.73
PC		51+41.68	1606583.41	226199.71
BEARING	N71°29'26.33"E			
LENGTH	141.68			
CURVE				
PC		51+41.68	1606583.41	226199.71
PI		51+90.89	1606630.07	226215.33
CC			1606356.74	226876.78
PRC		52+39.94	1606674.15	226237.21
R	714.00			
Δ	7°53'05.39"			
D	8°01'28.63"			
L	98.26			
T	49.21			
CHORD	98.18			
M.O.	1.69			
E	1.69			
CURVE				
PRC		52+39.94	1606674.15	226237.21
PI		52+96.36	1606724.68	226262.29
CC			1606740.83	226102.84
PCC		53+47.87	1606779.22	226247.85
R	150.00			
Δ	41°13'27.69"			
D	38°11'49.87"			
L	107.93			
T	56.42			
CHORD	105.61			
M.O.	9.60			
E	10.26			
CURVE				
PCC		53+47.87	1606779.22	226247.85
PI		53+58.61	1606789.60	226245.10
CC			1606774.10	226228.51
PCC		53+67.58	1606793.05	226234.92
R	20.00			
Δ	56°28'16.14"			
D	286°28'44.03"			
L	19.71			
T	10.74			
CHORD	18.92			
M.O.	2.38			
E	2.70			
CURVE				
PCC		53+67.58	1606793.05	226234.92
PI		54+13.45	1606807.75	226191.47
CC			1606584.66	226164.39
PT		54+58.03	1606803.87	226145.77
R	220.00			
Δ	23°33'19.67"			
D	26°02'36.73"			
L	90.45			
T	45.87			
CHORD	89.81			
M.O.	4.63			
E	4.73			
TANGENT				
PT		54+58.03	1606803.87	226145.77
PC		55+97.79	1606792.04	226006.51
BEARING	S4°51'24.43"W			
LENGTH	139.76			

ALIGNMENT DATA FOR AL-6				
		STATION	X COORD	Y COORD
TANGENT				
POB		60+00.00	1606816.08	226003.17
PC		60+66.85	1606829.81	226068.59
BEARING	N11°51'04.63"E			
LENGTH	66.85			
CURVE				
PC		60+66.85	1606829.81	226068.59
PI		61+04.15	1606837.47	226105.10
CC			1606228.90	226194.69
PRC		61+41.36	1606840.65	226142.27
R	614.00			
Δ	6°57'12.22"			
D	9°19'53.62"			
L	74.51			
T	37.30			
CHORD	74.47			
M.O.	1.13			
E	1.13			
CURVE				
PRC		61+41.36	1606840.65	226142.27
PI		62+03.72	1606845.98	226204.41
CC			1606990.11	226129.46
PRC		62+59.57	1606893.79	226244.45
R	150.00			
Δ	45°09'03.72"			
D	38°11'49.87"			
L	118.21			
T	62.36			
CHORD	115.17			
M.O.	11.49			
E	12.45			
CURVE				
PRC		62+59.57	1606893.79	226244.45
PI		62+68.38	1606900.54	226250.11
CC			1606845.63	226301.95
PRC		62+77.11	1606905.80	226257.18
R	75.00			
Δ	13°24'21.38"			
D	76°23'39.74"			
L	17.55			
T	8.81			
CHORD	17.51			
M.O.	0.51			
E	0.52			
CURVE				
PRC		62+77.11	1606905.80	226257.18
PI		63+43.72	1606945.56	226310.63
CC			1607082.33	226125.88
PRC		64+06.46	1607008.27	226333.04
R	220.00			
Δ	33°41'14.35"			
D	26°02'36.73"			
L	129.35			
T	66.60			
CHORD	127.49			
M.O.	9.44			
E	9.86			
CURVE				
PRC		64+06.46	1607008.27	226333.04
PI		64+42.91	1607042.59	226345.31
CC			1606700.62	227193.71
PRC		64+79.32	1607075.82	226360.27
R	914.00			
Δ	4°34'00.39"			
D	6°16'07.27"			
L	72.85			
T	36.44			
CHORD	72.83			
M.O.	0.73			
E	0.73			
CURVE				
PRC		64+79.32	1607075.82	226360.27
PI		65+38.00	1607129.34	226384.36
CC			1607609.48	225174.86
PT		65+96.60	1607184.80	226403.53
R	1300.00			
Δ	5°10'09.72"			
D	4°24'26.52"			
L	117.29			
T	58.68			
CHORD	117.25			
M.O.	1.32			
E	1.32			
TANGENT				
PT		65+96.60	1607184.80	226403.53
POE		66+68.38	1607252.64	226426.98
BEARING	N70°55'58.43"E			
LENGTH	71.77			

ALIGNMENT DATA FOR AL-7				
		STATION	X COORD	Y COORD
TANGENT				
POB		70+00.00	1606874.45	226641.19
PC		70+80.81	1606880.49	226560.61
BEARING	S4°17'02.79"E			
LENGTH	80.81			
CURVE				
PC		70+80.81	1606880.49	226560.61
PI		71+32.27	1606884.33	226509.29
CC			1606018.90	226496.06
PRC		71+83.61	1606882.06	226457.88
R	864.00			
Δ	6°49'00.76"			
D	6°37'53.24"			
L	102.80			
T	51.46			
CHORD	102.74			
M.O.	1.53			
E	1.53			
CURVE				
PRC		71+83.61	1606882.06	226457.88
PI		72+27.62	1606880.11	226413.92
CC			1607101.84	226448.16
PCC		72+70.48	1606895.23	226372.59
R	220.00			
Δ	22°37'26.30"			
D	26°02'36.73"			
L	86.87			
T	44.01			
CHORD	86.31			
M.O.	4.27			
E	4.36			
CURVE				
PCC		72+70.48	1606895.23	226372.59
PI		72+81.90	1606899.15	226361.86
CC			1606914.01	226379.46
PCC		72+91.24	1606910.39	226359.79
R	20.00			
Δ	59°28'25.12"			
D	286°28'44.03"			
L	20.76			
T	11.42			
CHORD	19.84			
M.O.	2.63			
E	3.03			
CURVE				
PCC		72+91.24	1606910.39	226359.79
PI		73+46.11		

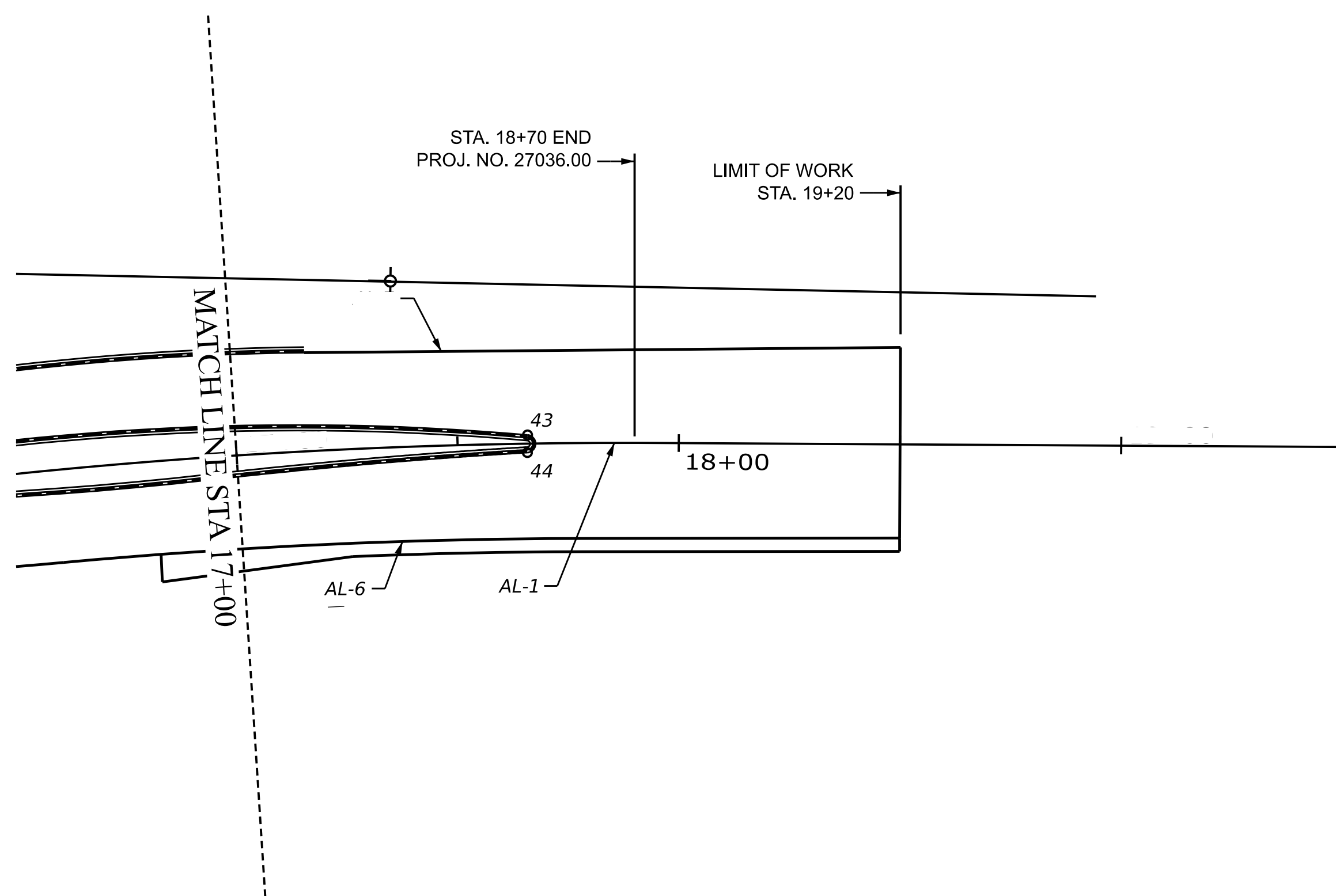
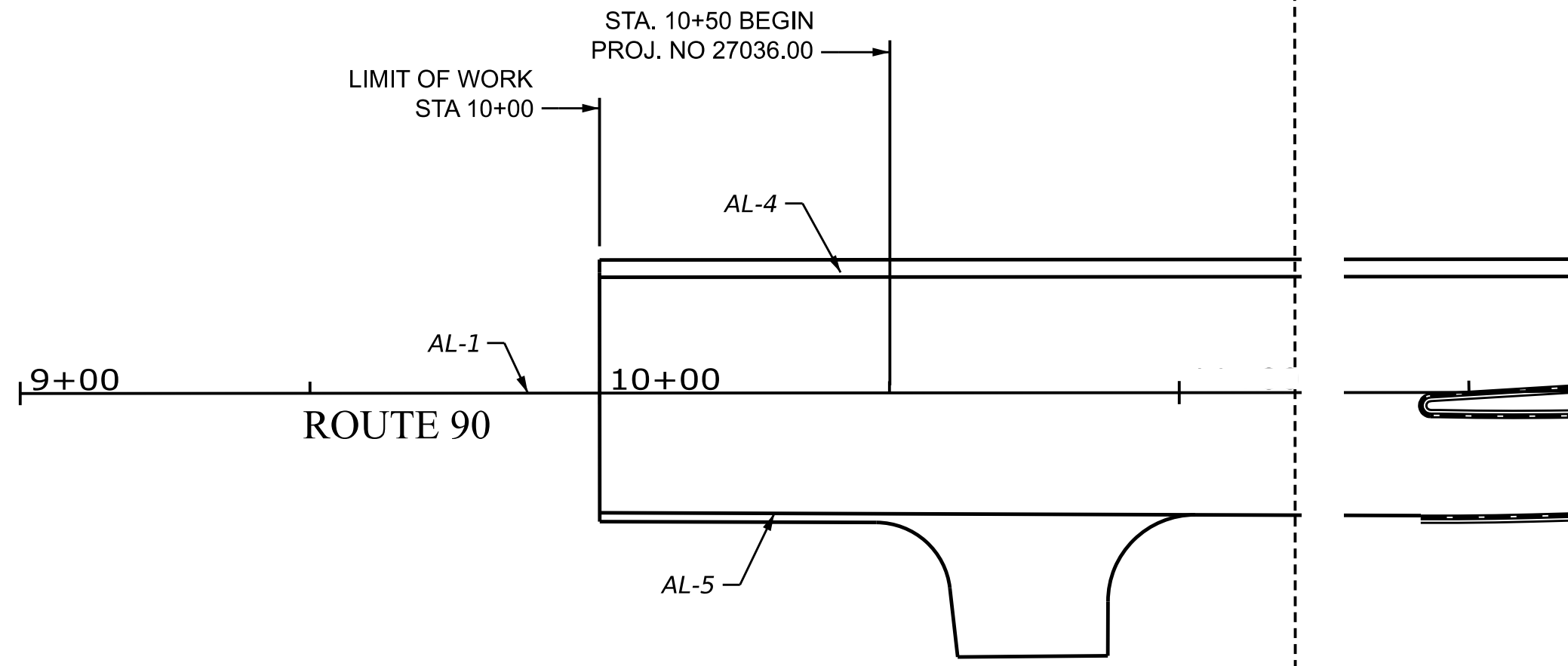
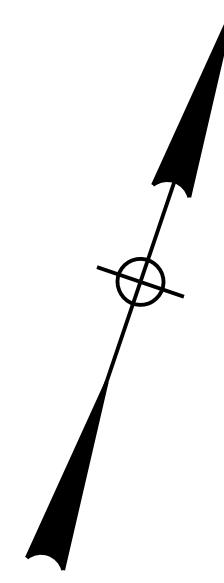

ITEM 609.21 CONCRETE SLIPFORM CURB - MOLD 5							
PT TO PT	LENGTH	RADIUS	BEARING/DELTA	PT TO PT	LENGTH	RADIUS	BEARING/DELTA
TANGENT & CURVE DATA FOR NW				TANGENT & CURVE DATA FOR ISLO3			
2 TO 3	92.66'	220.00'	024°07'59.01"	49 TO 50	27.23'	-	N07°38'00.41"E
3 TO 4	37.71'	-	N43°58'46.04"E	50 TO 51	78.29'	240.00'	018°41'21.61"
4 TO 5	26.29'	150.00'	010°02'34.66"	51 TO 52	5.63'	3.00'	107°30'49.82"
8 TO 9	45.45'	150.00'	017°21'40.74"	52 TO 53	26.27'	-	S83°32'31.38"E
TANGENT & CURVE DATA FOR SW				TANGENT & CURVE DATA FOR ISLO4			
12 TO 13	94.26'	714.00'	007°33'49.85"	53 TO 54	1.99'	1.00'	113°53'38.68"
13 TO 14	107.93'	150.00'	041°13'27.69"	54 TO 55	63.48'	165.00'	022°02'30.10"
14 TO 15	19.71'	20.00'	056°28'16.14"	55 TO 56	45.50'	-	S08°18'37.20"W
15 TO 16	47.63'	220.00'	012°24'19.17"	56 TO 49	6.26'	2.00'	179°19'23.22"
TANGENT & CURVE DATA FOR SE				TANGENT & CURVE DATA FOR ISLO5			
18 TO 19	20.85'	614.00'	001°56'44.52"	57 TO 58	1.99'	1.00'	114°02'58.70"
19 TO 20	118.21'	150.00'	045°09'03.72"	58 TO 59	12.61'	165.00'	004°22'39.71"
20 TO 21	17.51'	75.00'	013°22'40.94"	59 TO 60	1.17'	1.00'	066°57'31.55"
21 TO 22	125.35'	220.00'	032°38'44.03"	60 TO 61	21.76'	60.00'	020°46'43.84"
TANGENT & CURVE DATA FOR NE				TANGENT & CURVE DATA FOR ISLO6			
25 TO 26	82.87'	220.00'	021°34'55.98"	61 TO 62	0.99'	1.00'	056°36'34.76"
26 TO 27	20.76'	20.00'	059°28'25.12"	62 TO 63	6.83'	240.00'	001°37'47.12"
27 TO 28	105.20'	150.00'	040°11'05.05"	63 TO 64	5.63'	3.00'	107°36'37.99"
28 TO 29	105.83'	614.00'	009°52'31.69"	64 TO 57	25.92'	-	N85°12'53.72"W
TANGENT & CURVE DATA FOR ISLO1				TANGENT & CURVE DATA FOR ISLO7			
31 TO 32	100.24'	-	N67°50'18.22"E	65 TO 66	1.91'	1.00'	109°24'17.13"
32 TO 33	45.43'	900.00'	002°53'30.75"	66 TO 67	34.54'	165.00'	011°59'32.23"
33 TO 34	56.55'	240.00'	013°30'05.31"	67 TO 68	41.74'	-	N04°36'15.27"E
34 TO 35	5.63'	3.00'	107°31'02.90"	68 TO 69	6.28'	2.00'	179°46'24.46"
35 TO 36	26.25'	-	S15°15'13.43"E	69 TO 70	36.12'	-	S04°22'39.72"W
36 TO 37	1.99'	1.00'	113°53'59.62"	70 TO 71	30.00'	240.00'	007°09'39.03"
37 TO 38	100.19'	165.00'	034°47'31.51"	71 TO 65	15.70'	10.00'	089°58'29.67"
38 TO 39	105.10'	700.00'	008°36'09.16"	TANGENT & CURVE DATA FOR MISCO1			
39 TO 31	6.12'	2.00'	175°22'54.39"	78 TO 79	8.08'	34.00'	013°36'40.44"
TANGENT & CURVE DATA FOR ISLO2				TANGENT & CURVE DATA FOR MISCO1			
40 TO 41	1.99'	1.00'	114°05'23.74"	79 TO 80	2.07'	1.00'	118°20'27.58"
41 TO 42	100.66'	165.00'	034°57'12.55"	80 TO 81	6.79'	-	S00°02'57.74"W
42 TO 43	166.80'	600.00'	015°55'43.17"	81 TO 82	2.15'	1.00'	122°55'16.54"
43 TO 44	5.99'	2.00'	171°38'48.93"	82 TO 83	8.35'	34.00'	014°04'30.37"
44 TO 45	71.62'	1351.00'	003°02'14.79"	83 TO 78	2.56'	1.00'	146°25'26.69"
45 TO 46	114.13'	900.00'	007°15'56.83"				
46 TO 47	77.81'	240.00'	018°34'32.90"				
47 TO 48	5.64'	3.00'	107°38'07.57"				
48 TO 40	25.83'	-	N19°05'58.58"W				

ITEM 609.21 CONCRETE SLIPFORM CURB - MOLD 2			
PT TO PT	LENGTH	RADIUS	BEARING/DELTA
TANGENT & CURVE DATA FOR MISCO1			
73 TO 74	21.80'	20.00'	062°27'09.53"
74 TO 75	24.23'	-	N86°51'26.31"W
16 TO 76	18.47'	20.00'	052°55'08.17"
76 TO 77	30.77'	-	N82°54'42.19"E

ITEM 609.21 CONCRETE SLIPFORM CURB - MOLD 4			
PT TO PT	LENGTH	RADIUS	BEARING/DELTA
TANGENT & CURVE DATA FOR TA01			
- TO -	238.63'	38.00'	360°00'00.00"

ITEM 609.219 - CONCRETE SLIPFORM CURB - 4' TERMINAL END			
PT TO PT	LENGTH	RADIUS	BEARING/DELTA
TANGENT & CURVE DATA FOR NW			
1 TO 2	4.00'	220.00'	001°02'30.32"
5 TO 6	4.00'	150.00'	001°31'40.55"
7 TO 8	4.00'	150.00'	001°31'40.82"
9 TO 10	4.00'	150.00'	001°31'40.56"
TANGENT & CURVE DATA FOR SW			
11 TO 12	4.00'	714.00'	000°19'15.55"
TANGENT & CURVE DATA FOR SE			
17 TO 18	4.00'	614.00'	000°22'23.75"
22 TO 23	4.00'	220.00'	001°02'30.32"
TANGENT & CURVE DATA FOR NE			
24 TO 25	4.00'	220.00'	001°02'30.32"
29 TO 30	4.00'	614.00'	000°22'23.75"

ITEM 609.341 - CURB TYPE 5 - TRUCK APRON			
PT TO PT	LENGTH	RADIUS	BEARING/DELTA
TANGENT & CURVE DATA FOR TA01			
- TO -	333.01'	53.00'	360°00'00.00"

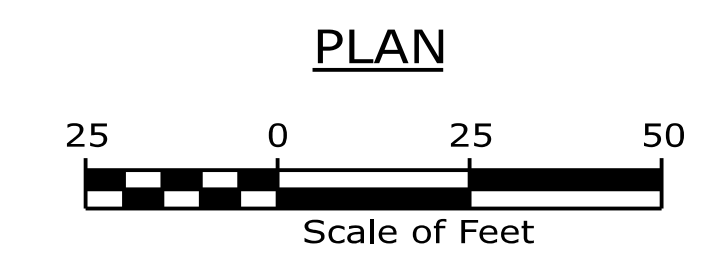

STATE OF MAINE DEPARTMENT OF TRANSPORTATION	WARREN ROUTE 90 AT WESTERN RD GEOMETRIC PLANS	SHEET NUMBER 30 OF 64
HIGHWAY PLANS 27036.00 WIN	BY: _____ PROJ. M-N-GER: _____ DESIGN-DET-LED: _____ CHECKED-REVIEWED: _____ DESIGN-DET-LEAD: _____ DESIGN-DET-LEAD: _____ REVISIONS 1: _____ REVISIONS 2: _____ REVISIONS 3: _____ REVISIONS 4: _____ FIELD CHANGES: _____	DATE: _____ P.E. NUMBER: _____ SIGNATURE: _____

CONTROL POINTS FOR NW					
POINT	STATION	OFFSET	SIDE	EASTING (X-COORD)	NORTHING (Y-COORD)
1	42+78.20	0.00'	-	1606698.15	226286.23
2	42+82.20	0.00'	-	1606701.88	226287.68
3	43+74.87	0.00'	-	1606778.17	226339.06
4	44+12.57	0.00'	-	1606804.36	226366.20
5	44+38.86	0.00'	-	1606820.87	226386.62
6	44+42.86	0.00'	-	1606823.06	226389.96
7	44+68.87	0.00'	-	1606835.03	226413.02
8	44+72.87	0.00'	-	1606836.51	226416.73
9	45+18.32	0.00'	-	1606846.13	226460.98
10	45+22.68	0.00'	-	1606846.34	226465.33

CONTROL POINTS FOR ISL01					
POINT	STATION	OFFSET	SIDE	EASTING (X-COORD)	NORTHING (Y-COORD)
31	11+43.28	0.27'	RT	1606578.18	226220.10
32	12+43.55	1.88'	LT	1606671.01	226257.91
33	12+88.84	2.29'	LT	1606713.50	226273.98
34	13+43.89	11.98'	LT	1606764.20	226298.73
35	13+47.81	9.22'	LT	1606768.72	226297.00
36	13+48.58	17.02'	RT	1606775.63	226271.67
37	13+47.17	17.98'	RT	1606774.51	226270.42
38	12+48.17	2.67'	RT	1606677.00	226255.41
39	11+43.35	4.26'	RT	1606579.54	226216.34

CONTROL POINTS FOR ISL04					
POINT	STATION	OFFSET	SIDE	EASTING (X-COORD)	NORTHING (Y-COORD)
57	24+24.97	14.02'	LT	1606841.38	226378.10
58	24+26.34	14.99'	LT	1606840.59	226379.58
59	24+38.23	10.84'	LT	1606846.24	226390.84
60	24+38.94	9.99'	LT	1606847.17	226391.43
61	24+37.27	11.59'	RT	1606868.36	226387.00
62	24+36.62	12.28'	RT	1606868.96	226386.27
63	24+30.19	14.55'	RT	1606870.38	226379.59
64	24+26.15	11.87'	RT	1606867.21	226375.94

CONTROL POINTS FOR ISL05					
POINT	STATION	OFFSET	SIDE	EASTING (X-COORD)	NORTHING (Y-COORD)
65	24+59.17	4.48'	LT	1606855.18	226410.74
66	24+60.33	5.63'	LT	1606854.17	226412.02
67	24+94.84	2.57'	LT	1606860.51	226445.91
68	25+36.66	1.34'	LT	1606863.86	226487.51
69	25+36.45	2.65'	RT	1606867.85	226487.20
70	25+00.44	1.62'	RT	1606865.09	226451.19
71	24+70.63	3.80'	RT	1606864.68	226421.21

CONTROL POINTS FOR NE					
POINT	STATION	OFFSET	SIDE	EASTING (X-COORD)	NORTHING (Y-COORD)
24	71+83.61	0.00'	-	1606882.06	226457.88
25	71+87.61	0.00'	-	1606881.92	226453.89
26	72+70.48	0.00'	-	1606895.23	226372.59
27	72+91.24	0.00'	-	1606910.39	226359.79
28	73+96.44	0.00'	-	1607011.99	226377.08
29	75+02.27	0.00'	-	1607107.93	226421.43
30	75+06.27	0.00'	-	1607111.70	226422.78

CONTROL POINTS FOR ISL02					
POINT	STATION	OFFSET	SIDE	EASTING (X-COORD)	NORTHING (Y-COORD)
40	14+98.82	14.08'	LT	1606913.56	226336.61
41	15+00.19	15.06'	LT	1606914.59	226337.94
42	15+99.57	3.86'	LT	1607011.36	226359.37
43	17+65.83	1.98'	LT	1607165.52	226421.65
44	17+65.71	2.01'	RT	1607166.76	226417.86
45	16+93.97	5.08'	RT	1607101.30	226388.84
46	15+80.01	2.35'	RT	1606995.39	226346.50
47	15+04.08	14.39'	RT	1606926.64	226310.79
48	15+00.04	11.72'	RT	1606922.01	226312.21

CONTROL POINTS FOR SW					
POINT	STATION	OFFSET	SIDE	EASTING (X-COORD)	NORTHING (Y-COORD)
11	51+41.68	0.00'	-	1606583.41	226199.71
12	51+45.68	0.00'	-	1606587.20	226200.99
13	52+39.94	0.00'	-	1606674.15	226237.21
14	53+47.87	0.00'	-	1606779.22	226247.85
15	53+67.58	0.00'	-	1606793.05	226234.92
16	54+15.21	0.00'	-	1606803.33	226188.51

CONTROL POINTS FOR MISC01					
POINT	STATION	OFFSET	SIDE	EASTING (X-COORD)	NORTHING (Y-COORD)
72	21+79.79	19.40'	LT	1606803.04	226136.01
73	21+83.37	21.19'	LT	1606801.76	226139.80
74	21+92.61	39.75'	LT	1606784.64	226151.51
75	21+90.61	63.89'	LT	1606760.45	226152.83
76	22+20.04	39.68'	LT	1606788.48	226178.66
77	22+12.08	69.40'	LT	1606757.95	226174.86
78	22+07.96	31.80'	LT	1606794.63	226165.62
79	22+11.91	24.78'	LT	1606802.13	226168.57
80	22+11.24	23.19'	LT	1606803.60	226167.69
81	22+04.52	22.27'	LT	1606803.59	226160.90
82	22+03.48	23.68'	LT	1606802.05	226160.06
83	22+06.06	31.60'	LT	1606794.56	226163.70

CONTROL POINTS FOR SE					
POINT	STATION	OFFSET	SIDE	EASTING (X-COORD)	NORTHING (Y-COORD)
17	61+16.51	0.00'	-	1606838.03	226117.56
18	61+20.51	0.00'	-	1606838.52	226121.53
19	61+41.36	0.00'	-	1606840.65	226142.27
20	62+59.06	0.00'	-	1606893.40	226244.13
21	62+77.11	0.00'	-	1606905.80	226257.18
22	64+02.46	0.00'	-	1607004.52	226331.66
23	64+06.46	0.00'	-	1607008.27	226333.04

CONTROL POINTS FOR ISL03					
POINT	STATION	OFFSET	SIDE	EASTING (X-COORD)	NORTHING (Y-COORD)
49	21+66.09	3.21'	LT	1606817.19	226120.22
50	21+93.32	3.33'	LT	1606820.81	226147.21
51	22+70.17	16.34'	LT	1606818.48	226225.11
52	22+74.14	13.57'	LT	1606821.77	226228.67
53	22+74.80	12.68'	RT	1606847.86	226225.71
54	22+73.41	13.63'	RT	1606848.61	226224.21
55	22+11.58	1.12'	RT	1606827.73	226164.69
56	21+66.08	0.79'	RT	1606821.16	226119.66

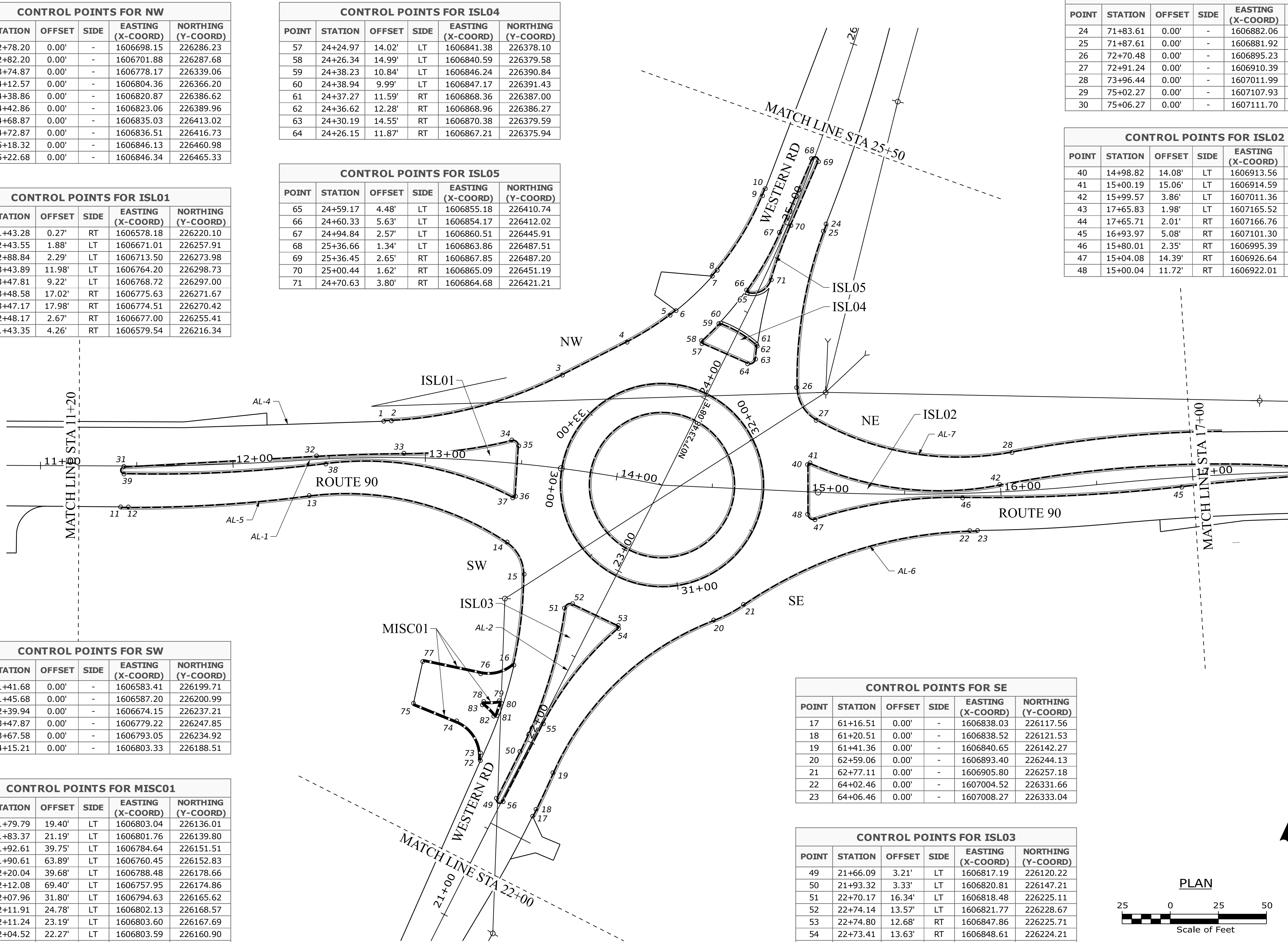

STATE OF MAINE
DEPARTMENT OF TRANSPORTATION

WARREN
ROUTE 90 AT WESTERN RD
GEOMETRIC PLANS

SHEET NUMBER
31
OF 64

WIN
27036.00
HIGHWAY PLANS

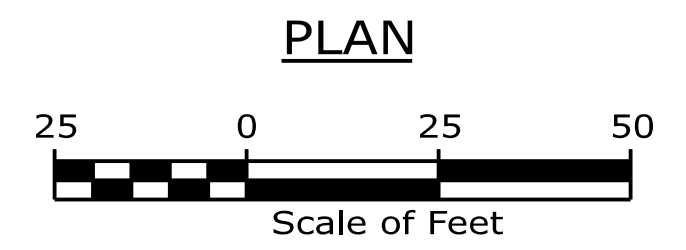
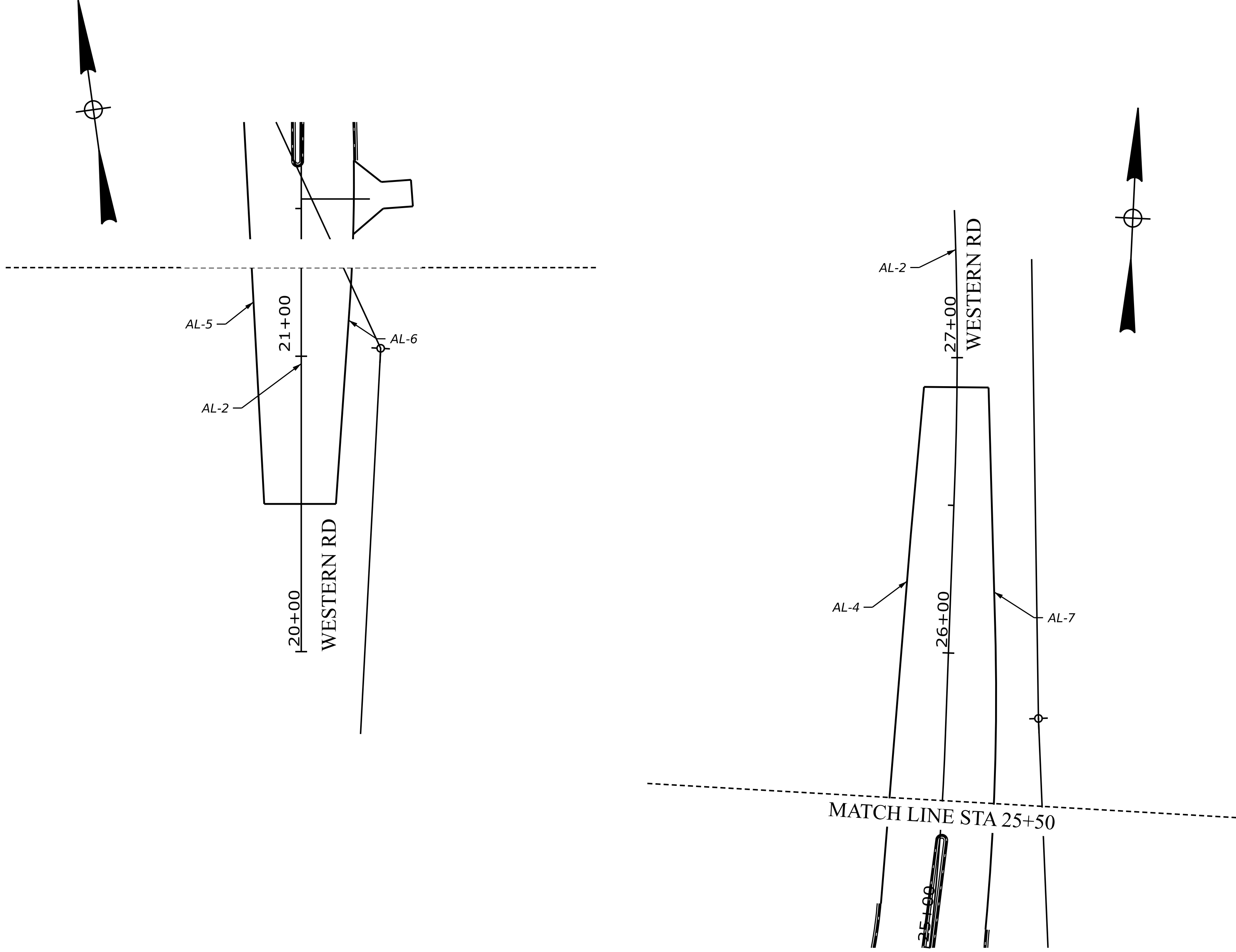

SHEET NUMBER

32

OF 64

WARREN
ROUTE 90 AT WESTERN RD
GEOMETRIC PLANS

PROJ. M-N-GER	BY	D-TE
DESIGN-DET-LED		
CHECKED-REVIEWED		
DESIGN-DET-LED		
DESIGN-DET-LED		
REVISIONS 1		
REVISIONS 2		
REVISIONS 3		
REVISIONS 4		
FIELD CHANGES		

SIGNATURE	P.E. NUMBER	DATE

STATE OF MAINE
DEPARTMENT OF TRANSPORTATION

WIN
27036.00
HIGHWAY PLANS

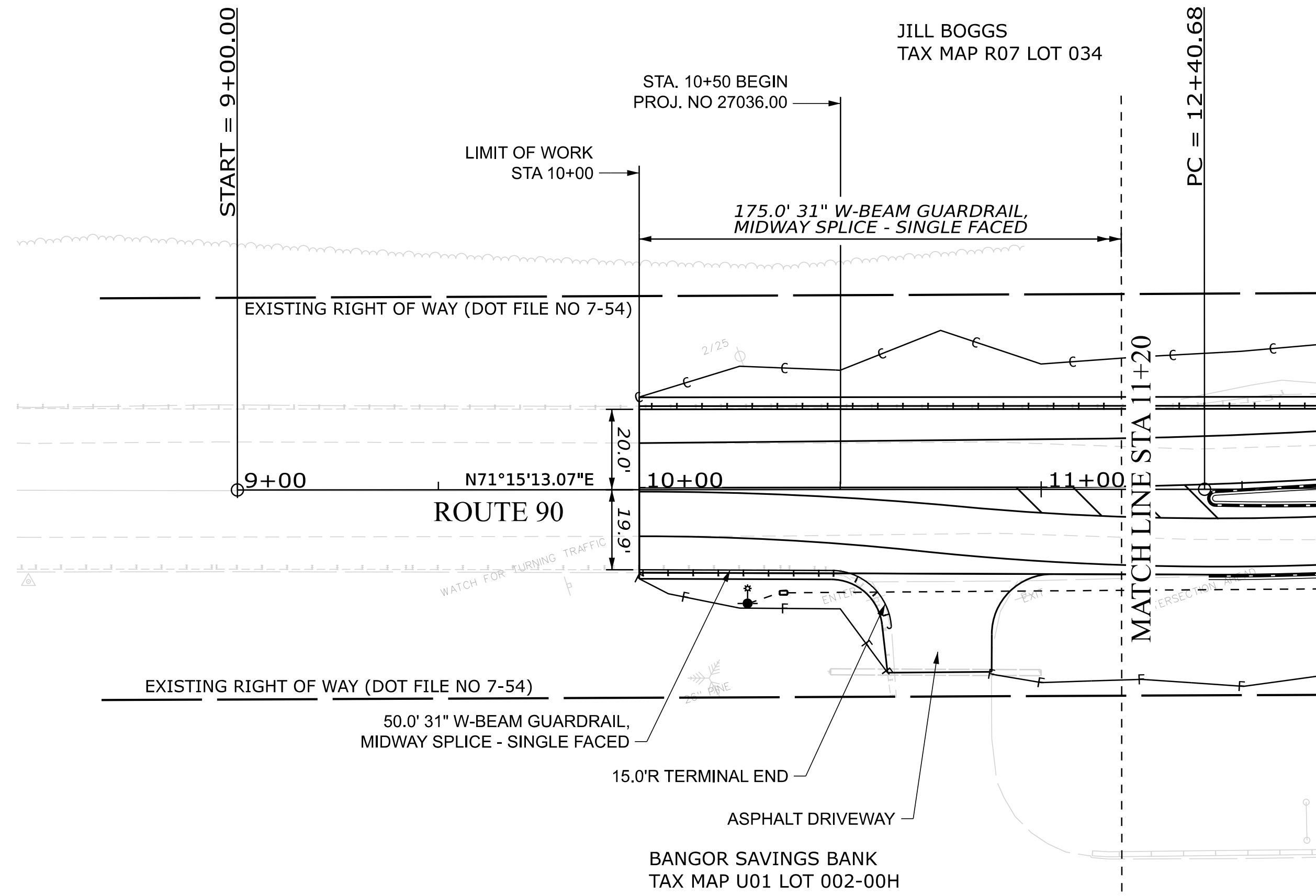

CURVE DATA
 PI = 17+23.48
 D = 04°14'38.84"
 Δ = 06°06'36.29" (RT)
 R = 1,350.00'
 L = 143.97'
 T = 72.05'
 E = 1.92'

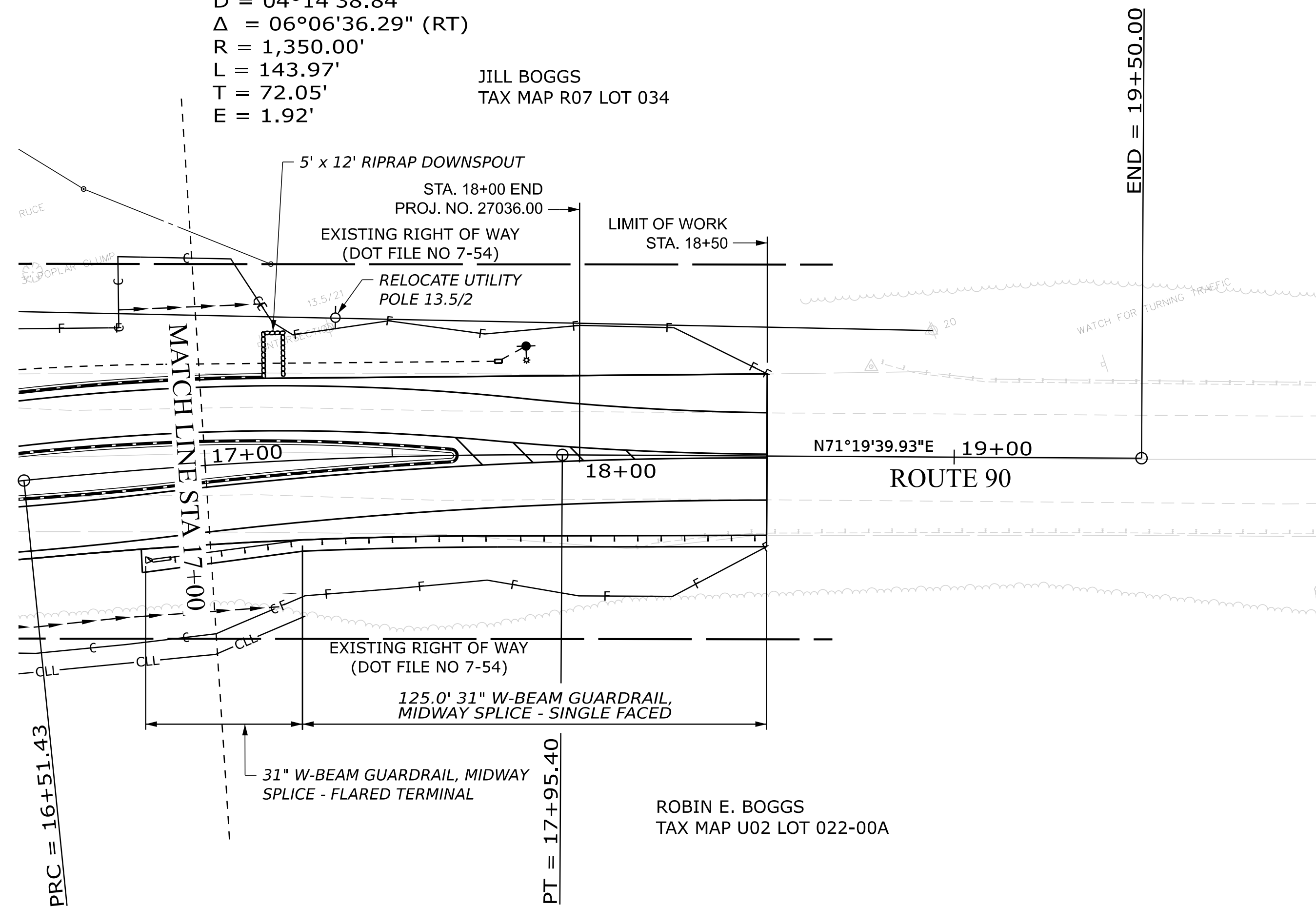

ROBIN E. BOGGS
 TAX MAP U02 LOT 022-00A

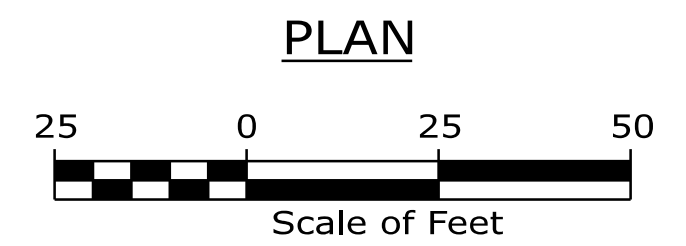

PLAN

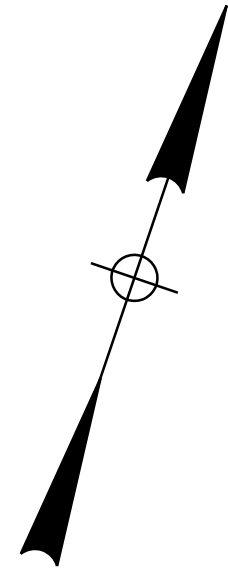

STATE OF MAINE
 DEPARTMENT OF TRANSPORTATION

SIGNATURE
 P.E. NUMBER
 DATE

PROJ. MANAGER	BY	DATE
DESIGN-DETAILED		
CHECKED-REVIEWED		
DESIGN-DETAILED 02		
DESIGN-DETAILED 03		
REVISIONS 1		
REVISIONS 2		
REVISIONS 3		
REVISIONS 4		
FIELD CHANGES		

WARREN
 ROUTE 90 AT WESTERN RD
 PLANS

SHEET NUMBER

33

OF 64

WIN
 27036.00
 HIGHWAY PLANS

Date: 2005/09/07

Username:

Division:

Filename: c:\pw_pit\strongwa\44321790\033_plans.dgn

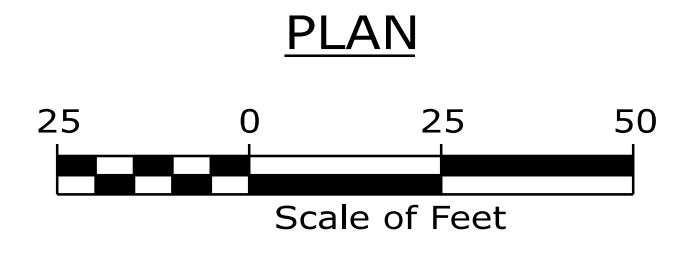
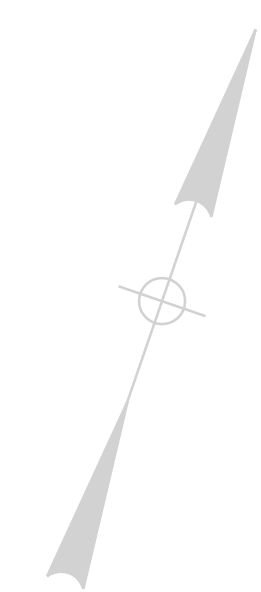
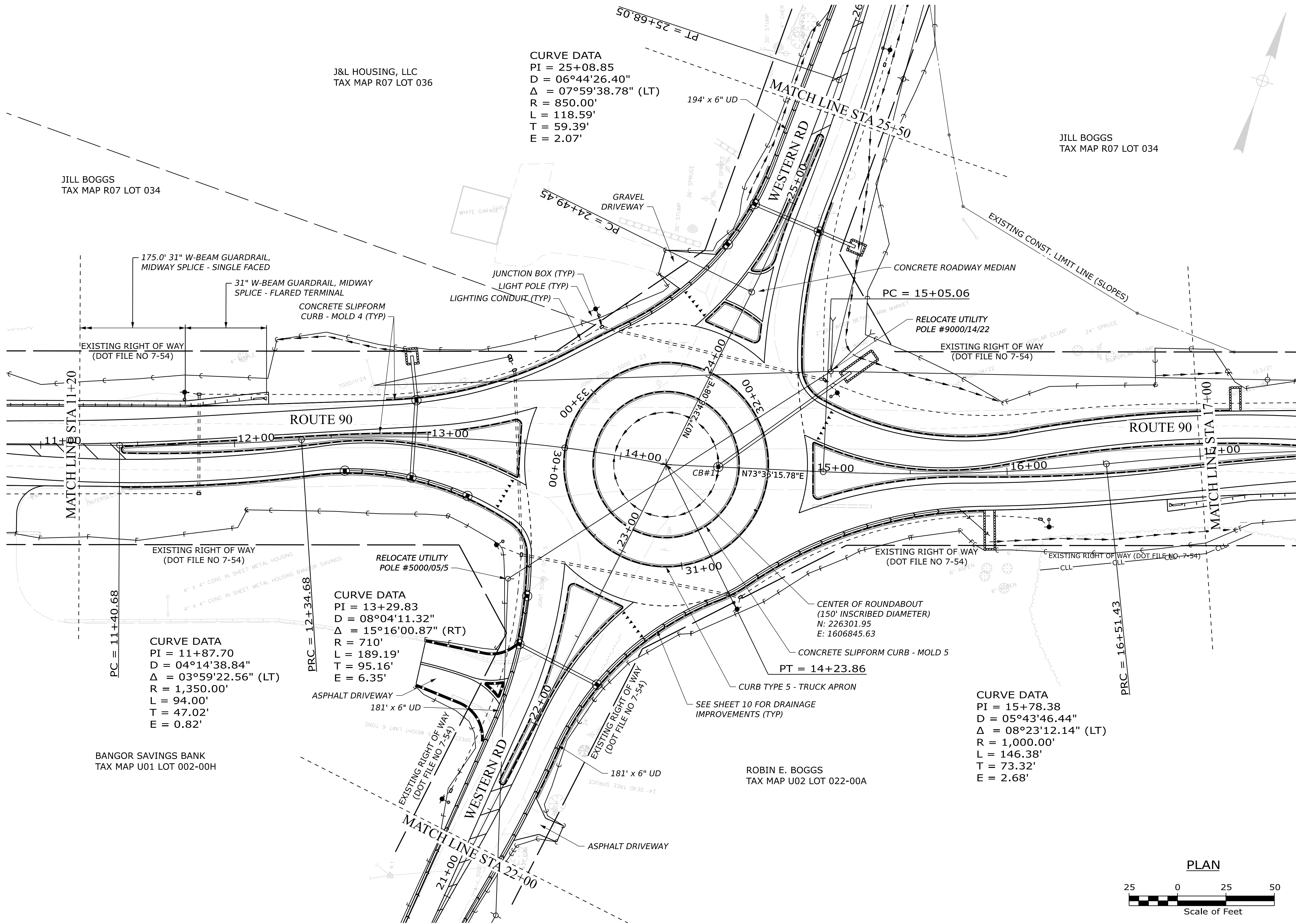

STATE OF MAINE
 DEPARTMENT OF TRANSPORTATION

PROJ. MANAGER	BY	DATE	DATE
DESIGN-DETAILED	X		
CHECKED-REVIEWED	X		
DESIGN-NET FILED	X		
DESIGN-DETAILED	X		
REVISIONS 1			
REVISIONS 2			
REVISIONS 3			
REVISIONS 4			
FIELD CHANGES			

WARREN
 ROUTE 90 AT WESTERN RD
 PLANS

SHEET NUMBER
 34
 OF 64

WIN
 27036.00
 HIGHWAY PLANS

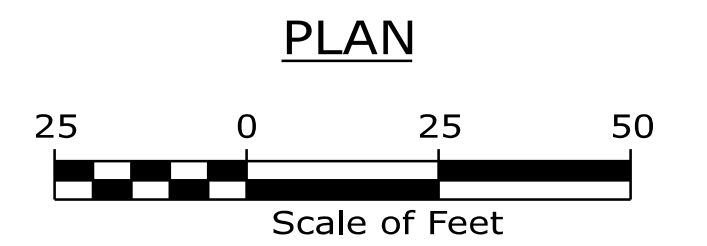
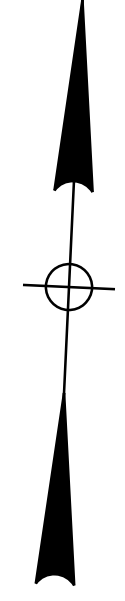
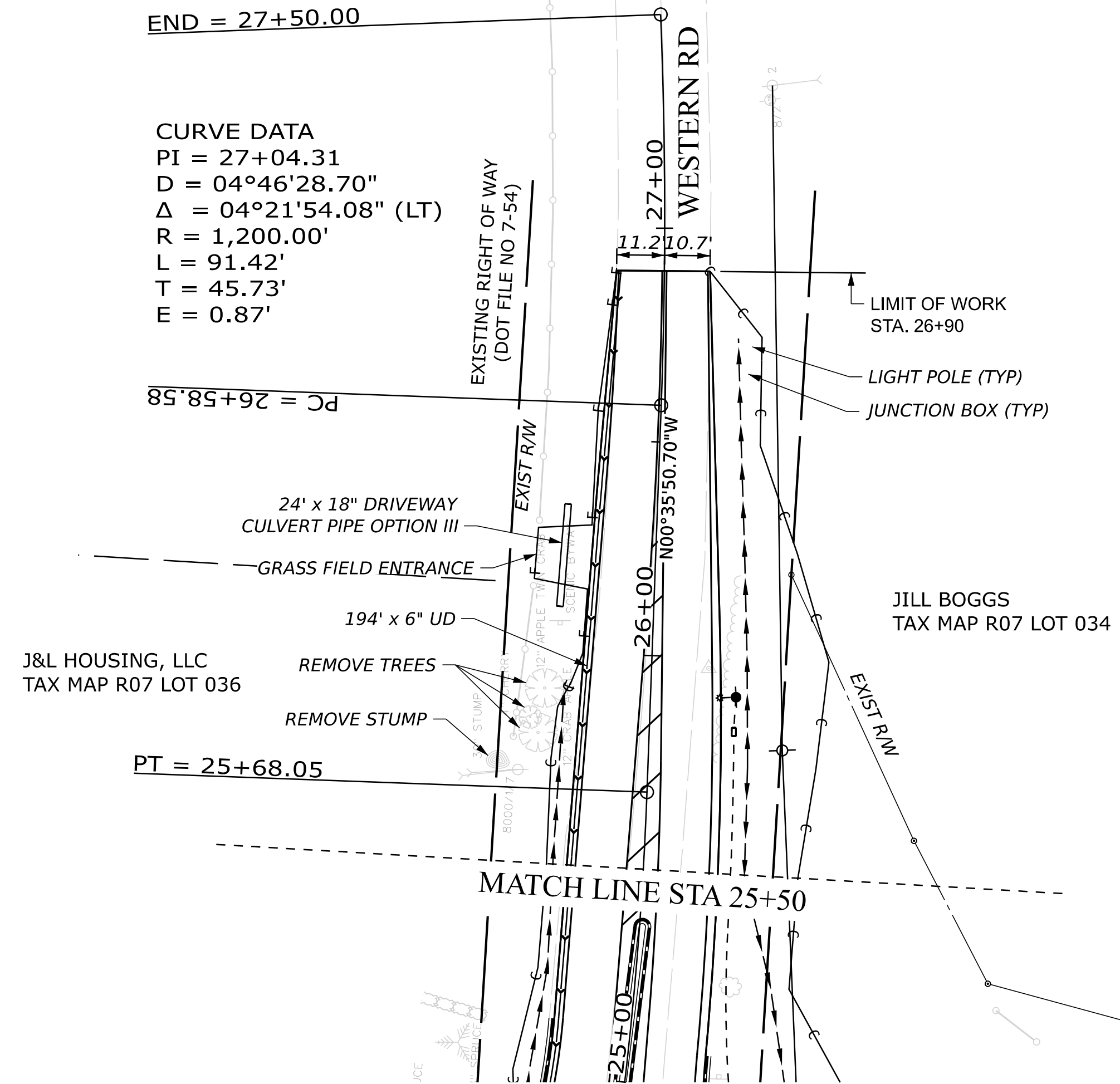
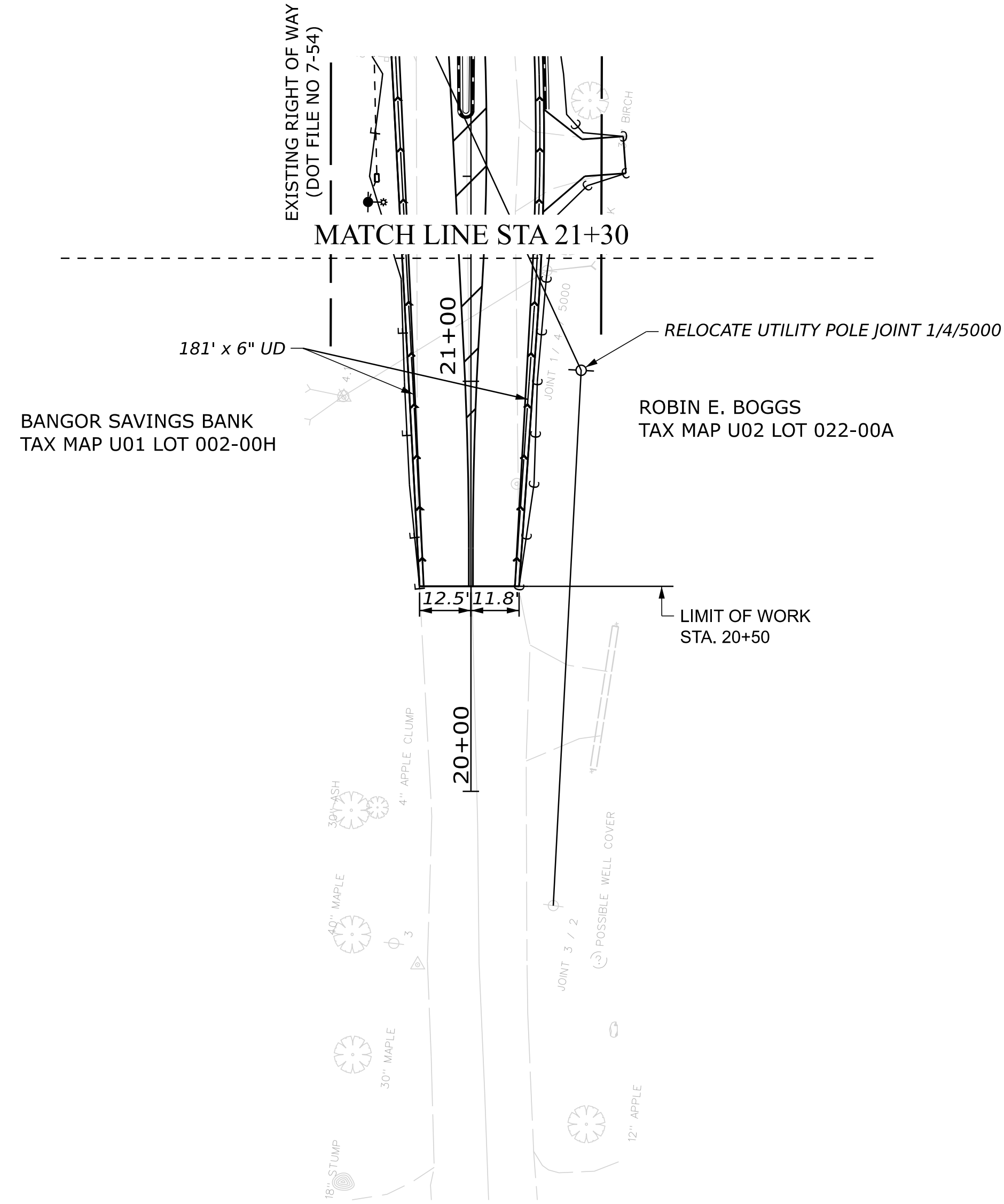
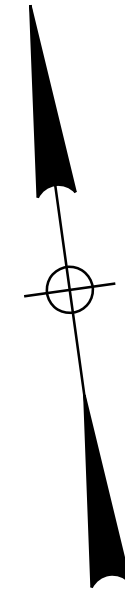

WARREN
ROUTE 90 AT WESTERN RD
PLANS

SHEET NUMBER

35

OF 64

STATE OF MAINE
DEPARTMENT OF TRANSPORTATION

PROJ. MANAGER	BY	DATE	SIGNATURE	P.E. NUMBER	DATE
DESIGN-DETAILED					
CHECKED-REVIEWED					
DESIGN-DET FILED 02					
DESIGN-DET FILED 03					
REVISIONS 1					
REVISIONS 2					
REVISIONS 3					
REVISIONS 4					
FIELD CHANGES					

WIN
27036.00
HIGHWAY PLANS

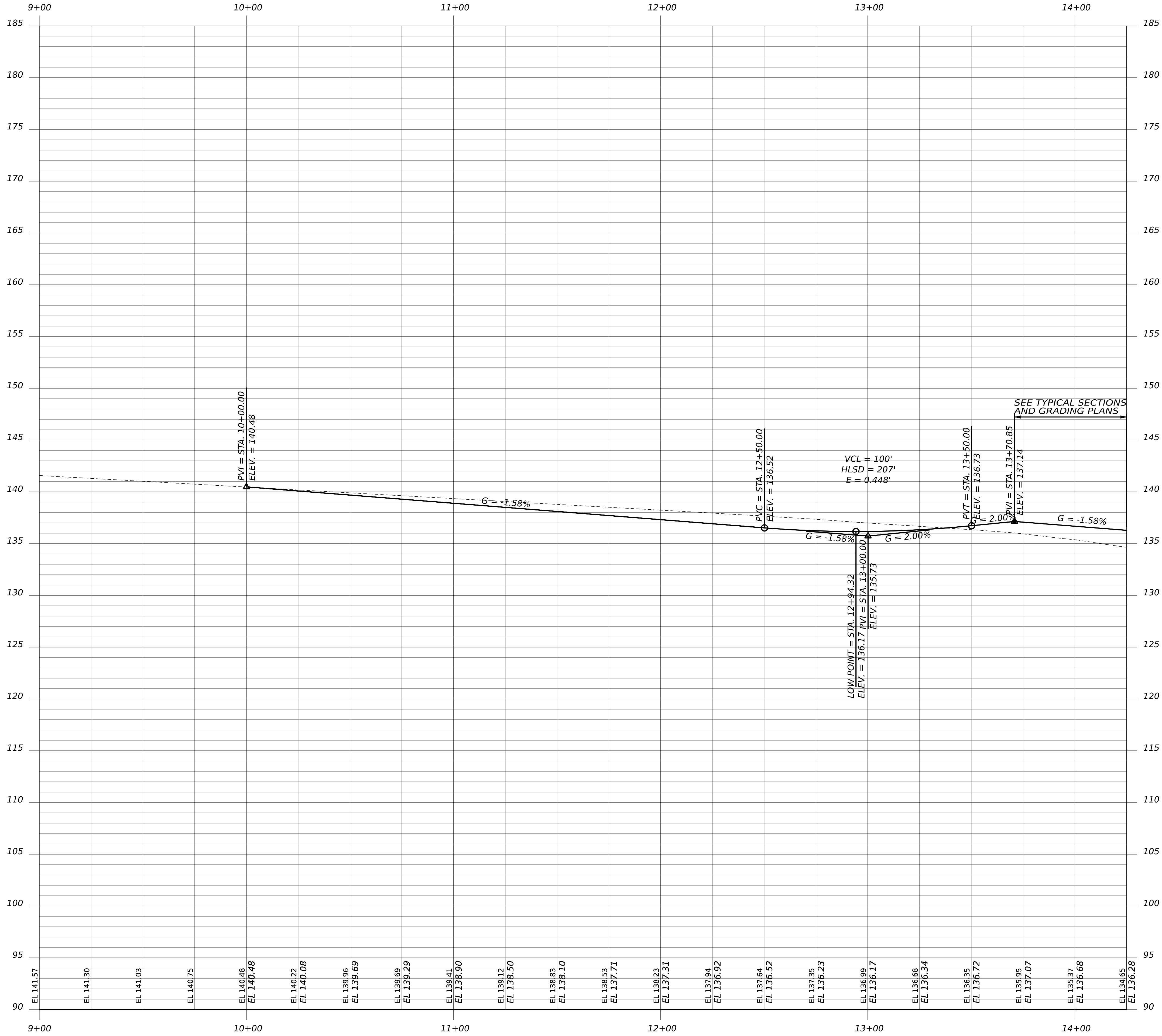

WARREN ROUTE 90 AT WESTERN RD		PROFILES	
STATE OF MAINE DEPARTMENT OF TRANSPORTATION			
PROJ. M-N-GER	BY	D-TE	SIGNATURE
DESIGN-DET-LED			
CHECKED-REVIEWED			
DESIGN-DET-LED			
DESIGN-DET-LED			
REVISIONS 1			P.E. NUMBER
REVISIONS 2			DATE
REVISIONS 3			
REVISIONS 4			
FIELD CHANGES			
SHEET NUMBER		HIGHWAY PLANS	
36		WIN 27036.00	
OF 64			

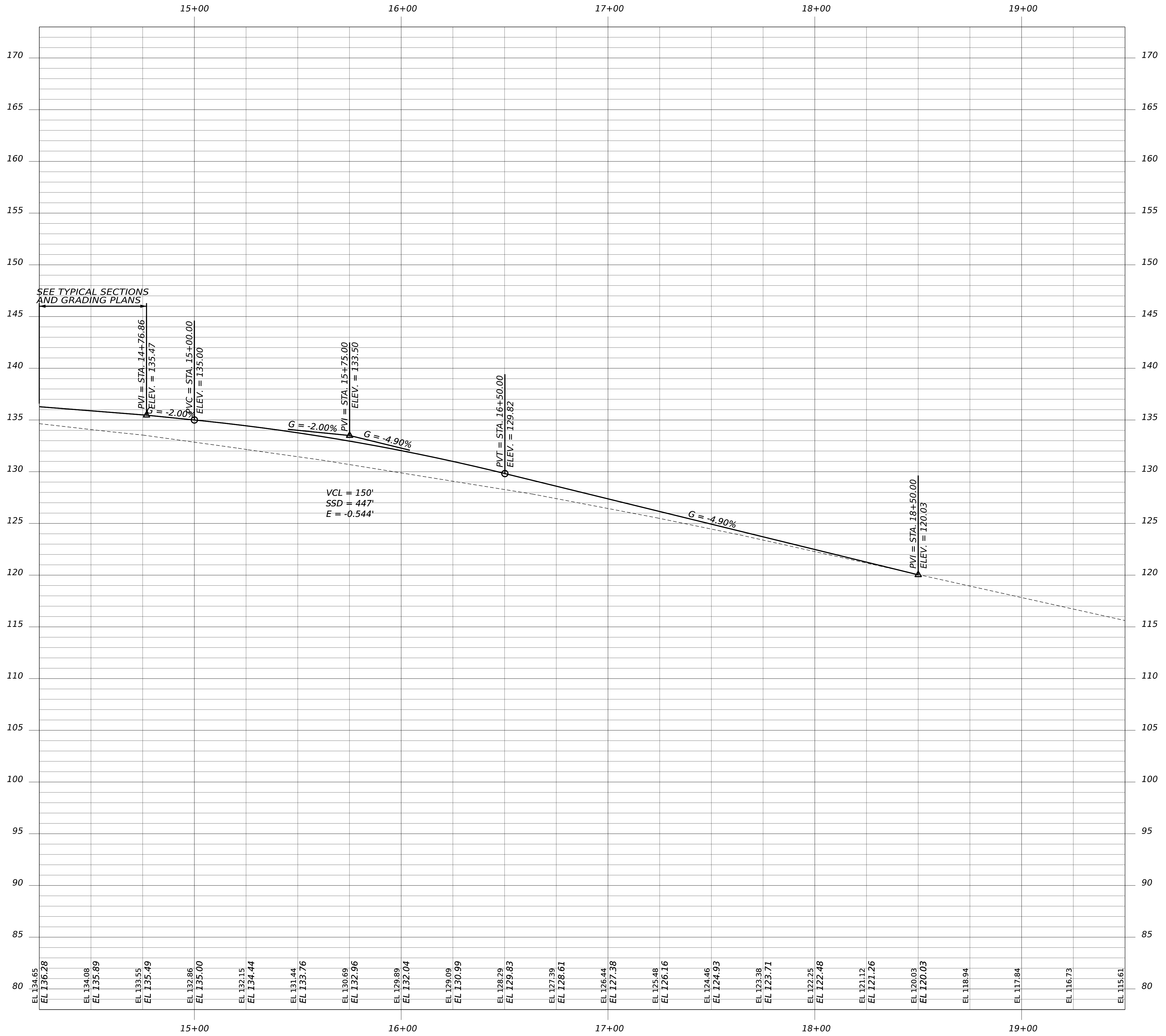

WARREN ROUTE 90 AT WESTERN RD		PROFILES	
SHEET NUMBER			
37			
OF 64			
		STATE OF MAINE DEPARTMENT OF TRANSPORTATION	WIN 27036.00 HIGHWAY PLANS
		BY	SIGNATURE
		PROJ. M-N-GER	P.E. NUMBER
		D-TE	DATE
		DESIGN-DET-LED	
		CHECKED-REVIEWED	
		DESIGN-DET-LED	
		DESIGN-DET-LED	
		REVISIONS 1	
		REVISIONS 2	
		REVISIONS 3	
		REVISIONS 4	
		FIELD CHANGES	

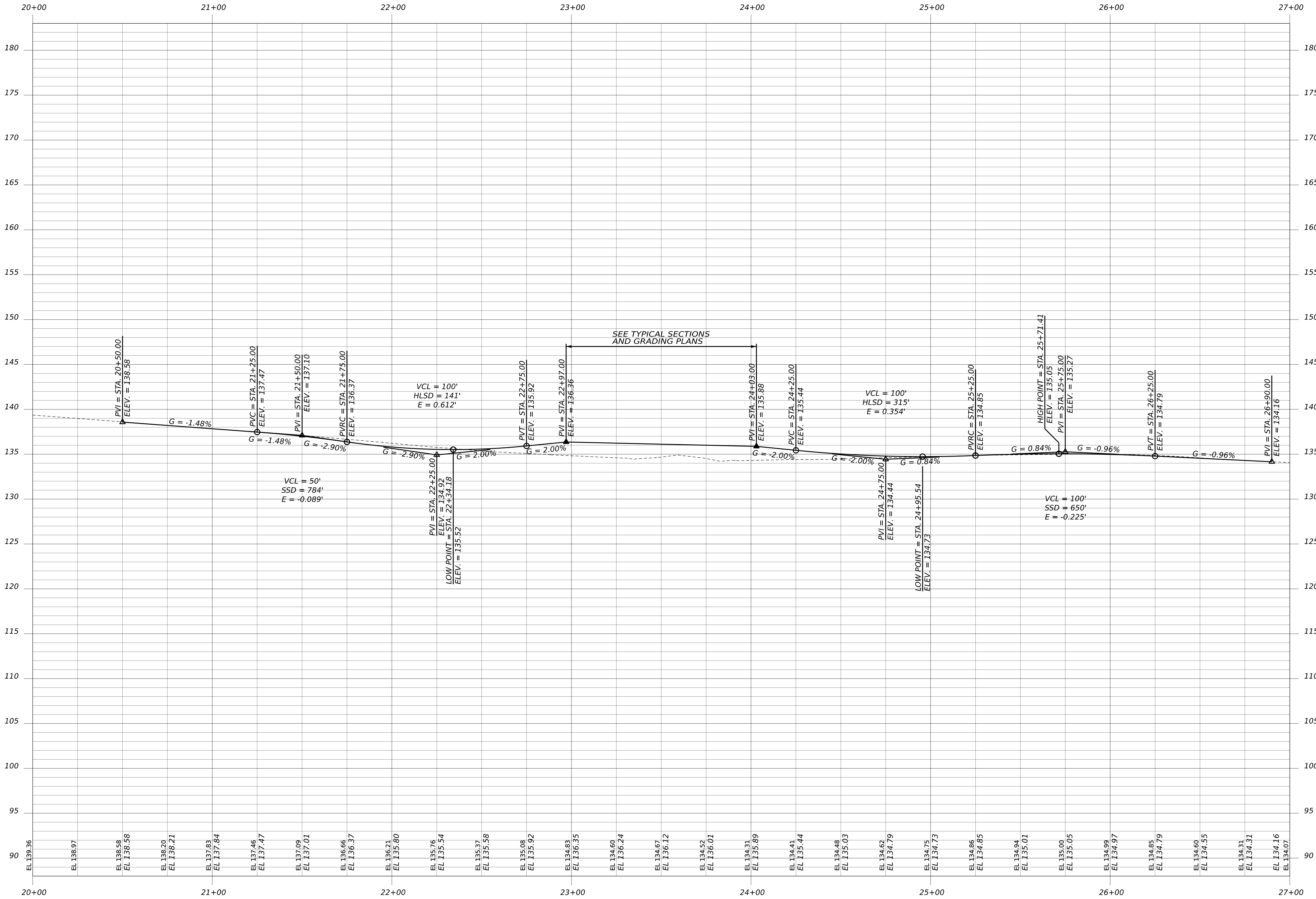

WARREN ROUTE 90 AT WESTERN RD		PROFILES	
SHEET NUMBER			
38			
OF 64			
PROJ. MANAGER	BY	DATE	SIGNATURE
DESIGN-DETAILED			
CHECKED-REVIEWED			
DESIGN-DETAILED			
DESIGN-DETAILED			
REVISIONS 1			P.E. NUMBER
REVISIONS 2			DATE
REVISIONS 3			
REVISIONS 4			
FIELD CHANGES			
STATE OF MAINE DEPARTMENT OF TRANSPORTATION		WIN 27036.00 HIGHWAY PLANS	

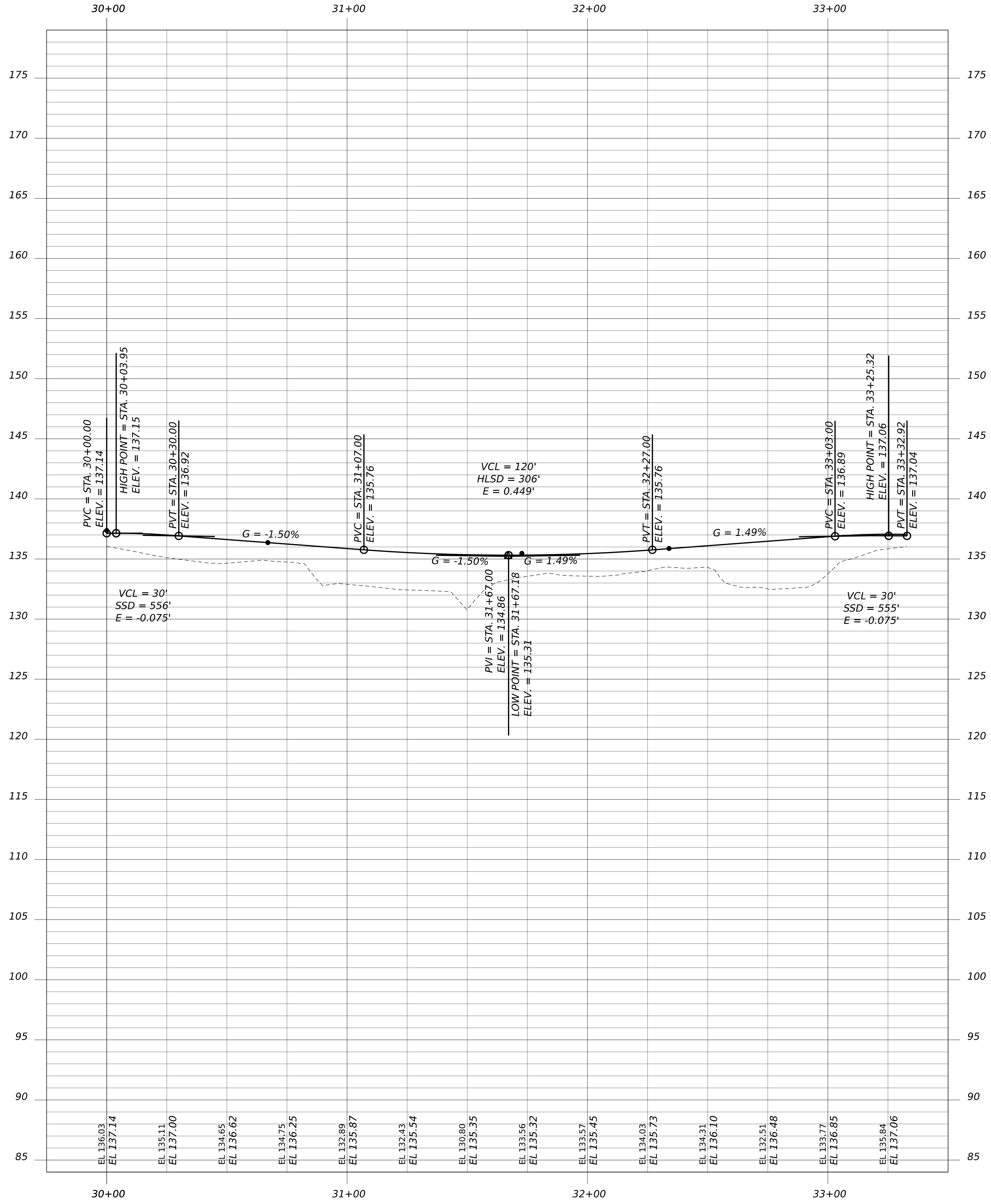

PROJ. M-N-GR	BY	D-T-E
DESIGN-DET-LED		
CHECKED-REVIEWED		
DESIGN-DET-LED		
DESIGN-DET-LED		
REVISIONS 1		
REVISIONS 2		
REVISIONS 3		
REVISIONS 4		
FIELD CHANGES		

SIGNATURE	P.E. NUMBER	DATE

Date: 2005/09/07

Username: \$user\$

Division:

Filename: c:\pw_pl\strongwa\44321790\040_cross_sections.dgn

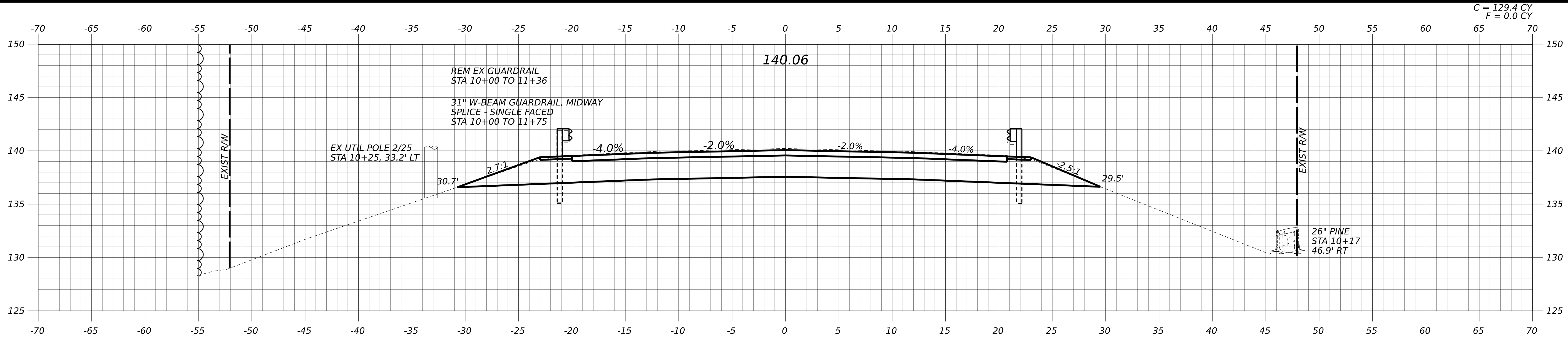

C = 129.4 CY
F = 0.0 CY

10+25.00

C = 72.9 CY
F = 0.0 CY

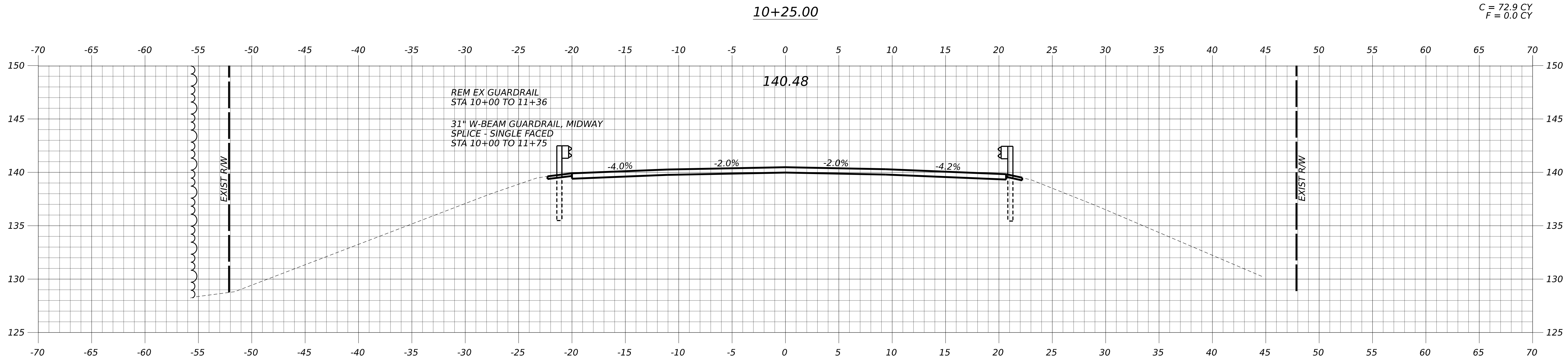

10+00.00 - LIMIT OF WORK

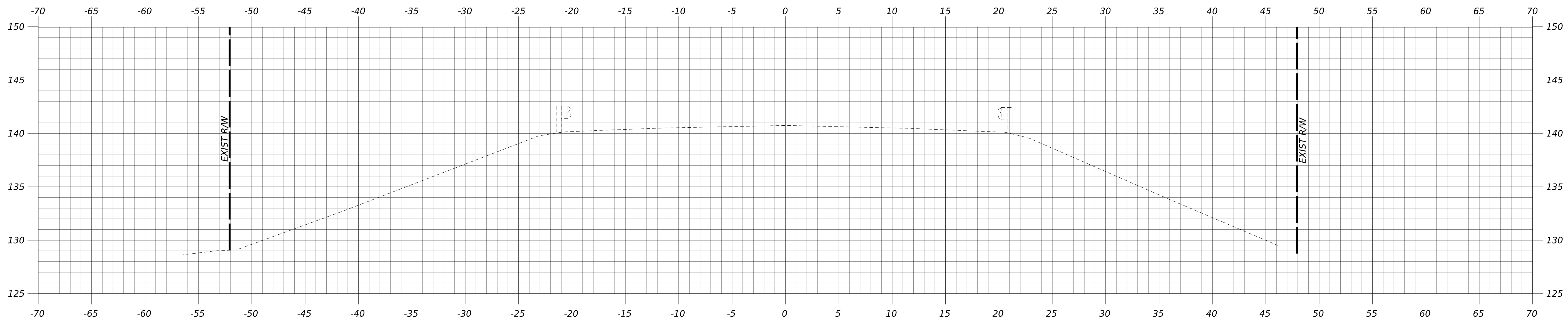

9+75.00

STATE OF MAINE
DEPARTMENT OF TRANSPORTATION

HIGHWAY PLANS
WIN
27036.00

PROJ. M-N-GER	BY	D-TE	SIGNATURE
DESIGN-DET-LED			
CHECKED-REVIEWED			
DESIGN-DET-LED			P.E. NUMBER
DESIGN-DET-LED			DATE
REVISIONS 1			
REVISIONS 2			
REVISIONS 3			
REVISIONS 4			
FIELD CHANGES			

WARREN
ROUTE 90 AT WESTERN RD
CROSS SECTIONS

SHEET NUMBER

40

OF 64

Date: 2005/09/07

Username: \$user\$

Division:

Filename: c:\pw_pl\strongwa\4321790\040_cross_sections.dgn



C = 149.5 CY
F = 13.3 CY

138.89

REM EX GUARDRAIL
STA 10+00 TO 11+36
31" W-BEAM GUARDRAIL, MIDWAY
SPlice - SINGLE FACED
STA 10+00 TO 11+75

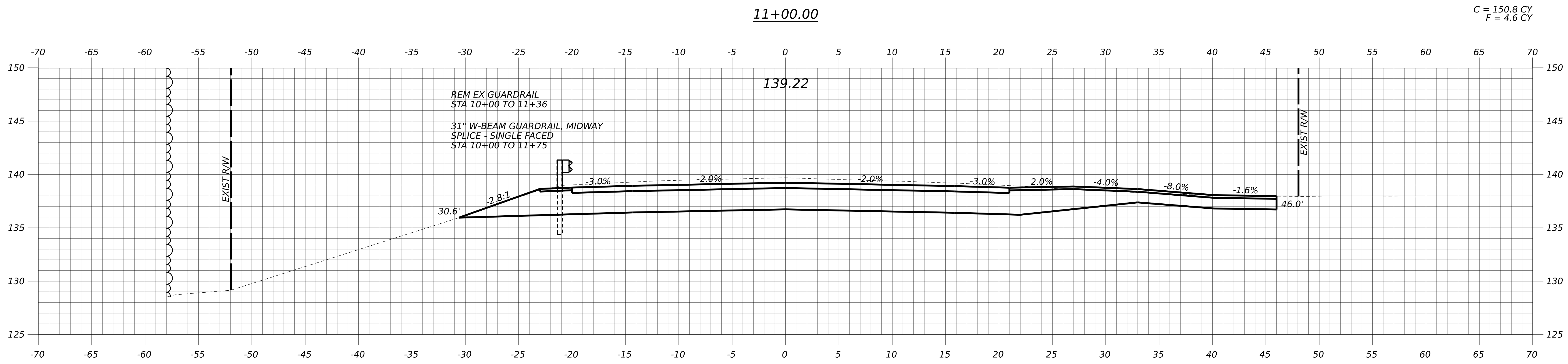

C = 150.8 CY
F = 4.6 CY

11+00.00

139.22

REM EX GUARDRAIL
STA 10+00 TO 11+36
31" W-BEAM GUARDRAIL, MIDWAY
SPlice - SINGLE FACED
STA 10+00 TO 11+75

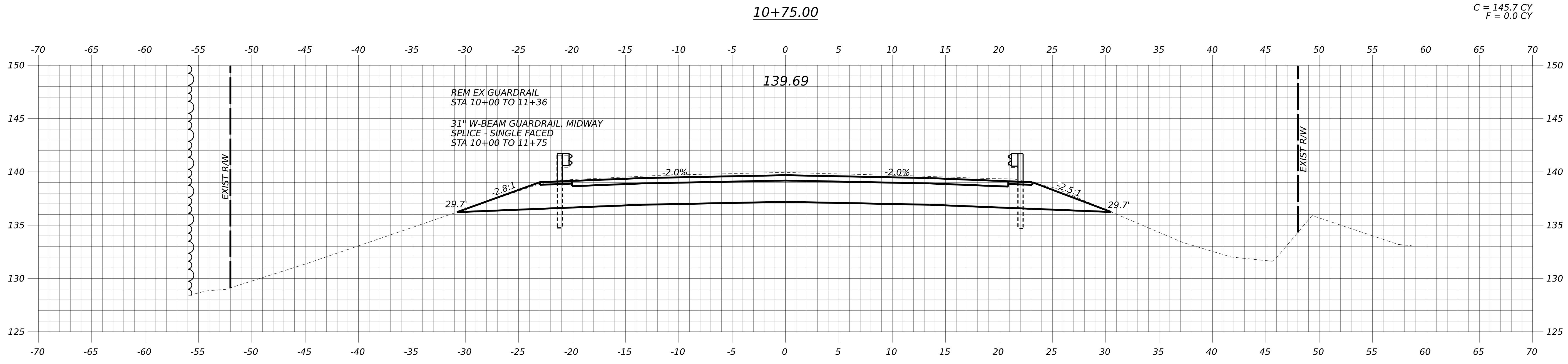

C = 145.7 CY
F = 0.0 CY

10+75.00

139.69

REM EX GUARDRAIL
STA 10+00 TO 11+36
31" W-BEAM GUARDRAIL, MIDWAY
SPlice - SINGLE FACED
STA 10+00 TO 11+75

10+50.00 - BEGIN PROJECT

STATE OF MAINE
DEPARTMENT OF TRANSPORTATION

PROJ. MANAGER	DATE	SIGNATURE
CHECKED-REVIEWED		
DESIGN-REVIEWED		
DESIGN-DETAILED		
REVISIONS 1		
REVISIONS 2		
REVISIONS 3		
REVISIONS 4		
FIELD CHANGES		

WARREN
ROUTE 90 AT WESTERN RD
CROSS SECTIONS

SHEET NUMBER
41
OF 64

HIGHWAY PLANS
WIN
27036.00

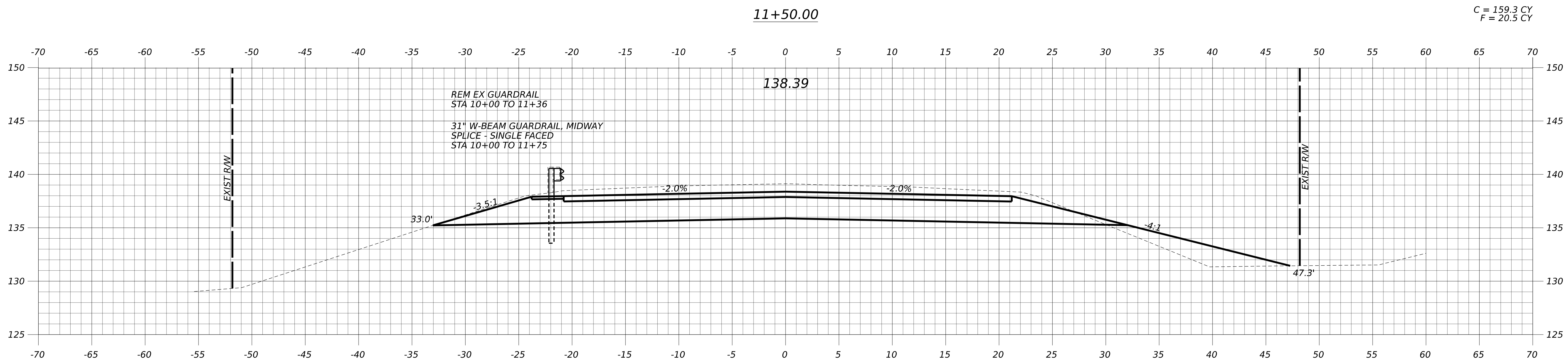
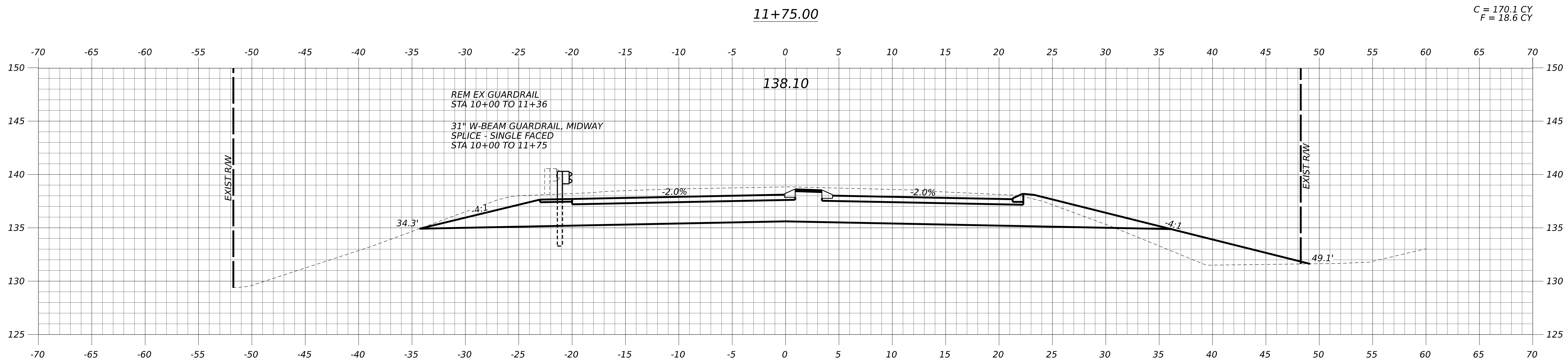
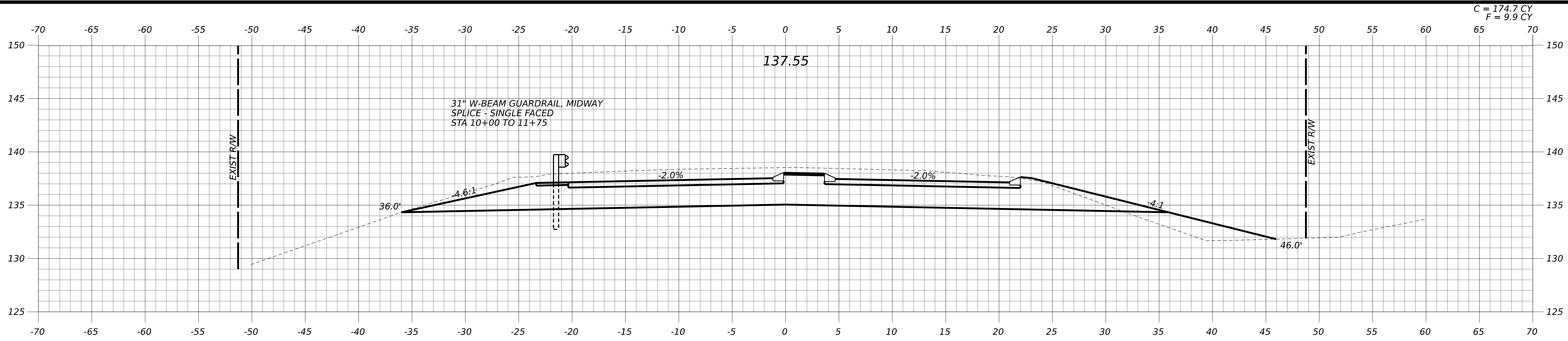

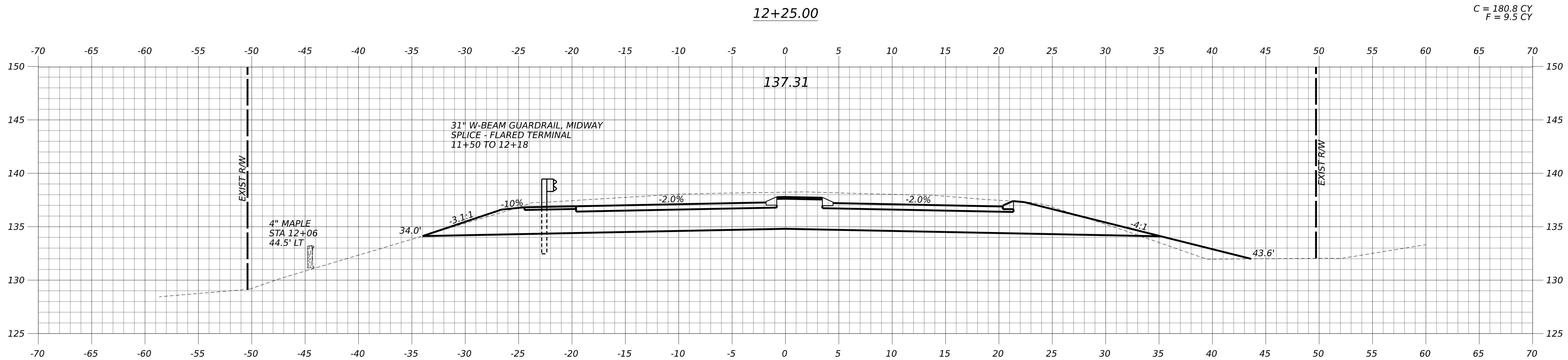
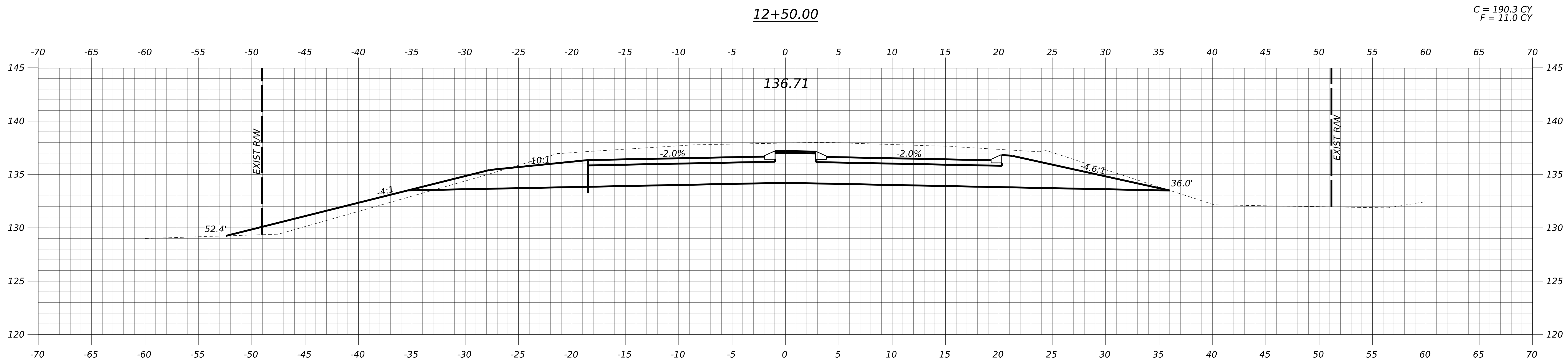
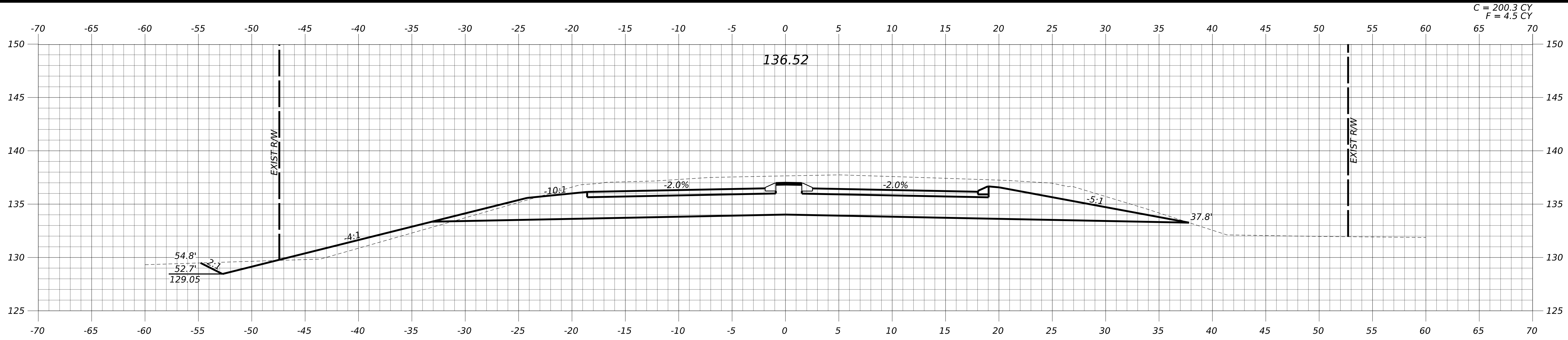

STATE OF MAINE
DEPARTMENT OF TRANSPORTATION

PROJ. M-N-GER	DESIGN-DET-LED	CHECKED-REVISED	DESIGN-DET-LED	DESIGN-DET-LED	REVISIONS 1	REVISIONS 2	REVISIONS 3	REVISIONS 4	FIELD CHANGES

WARREN
ROUTE 90 AT WESTERN RD

CROSS SECTIONS

SHEET NUMBER

43

OF 64

WIN
27036.00
HIGHWAY PLANS

Date: 2005/09/07

Username: \$user\$

Division:

Filename: c:\pw_pit\strongwa\4321790\040_cross_sections.dgn

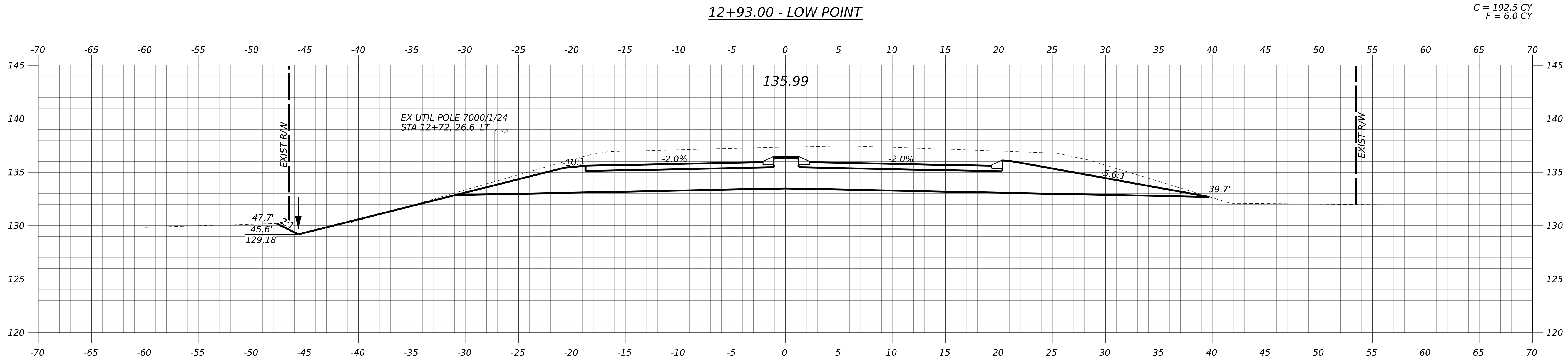
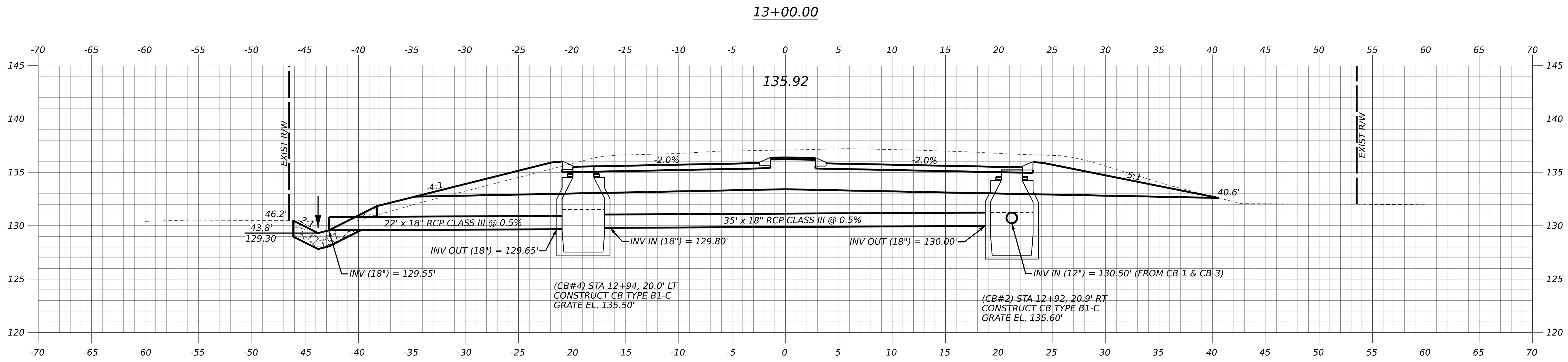
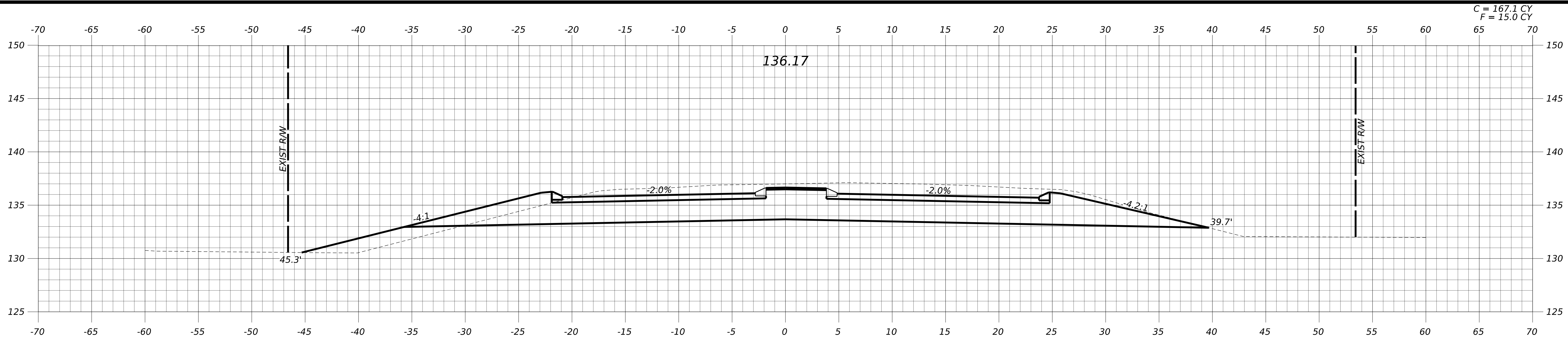

STATE OF MAINE
DEPARTMENT OF TRANSPORTATION

WIN
27036.00
HIGHWAY PLANS

PROJ. MANAGER	DATE	BY	SIGNATURE	P.E. NUMBER	DATE
DESIGN-DETAILED					
CHECKED-REVIEWED					
DESIGN-DETAILED					
REVISIONS 1					
REVISIONS 2					
REVISIONS 3					
REVISIONS 4					
FIELD CHANGES					

WARREN
ROUTE 90 AT WESTERN RD
CROSS SECTIONS

SHEET NUMBER

44

OF 64

Date: 2005/09/07

Username: \$user\$

Division:

Filename: c:\pw_pl\strongwa\44321790\040_cross_sections.dgn

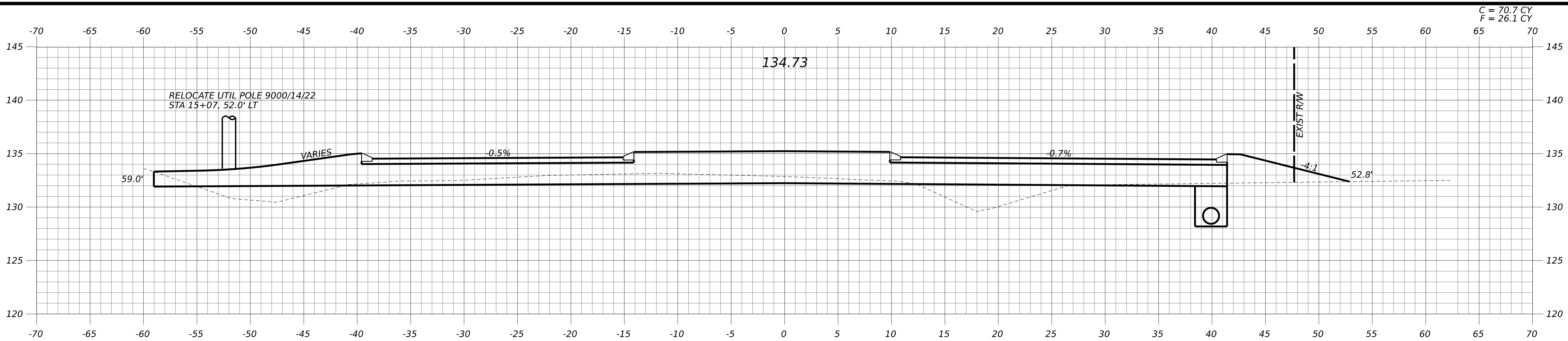

C = 70.7 CY
F = 26.1 CY

15+00.00

NOTE: REFER TO SHEETS 52 TO 56 FOR CROSS SECTIONS THROUGH THE ROUNDABOUT.

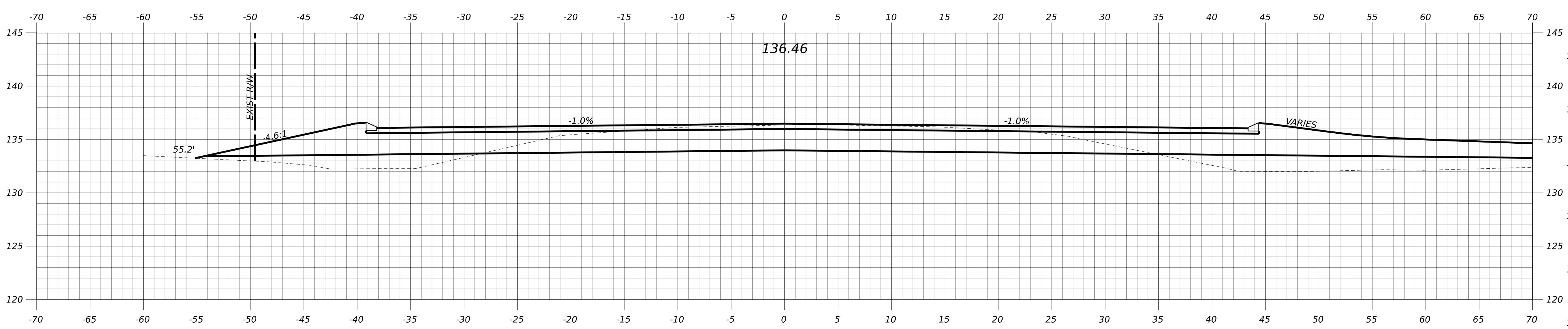

13+50.00

C = 133.5 CY
F = 38.3 CY

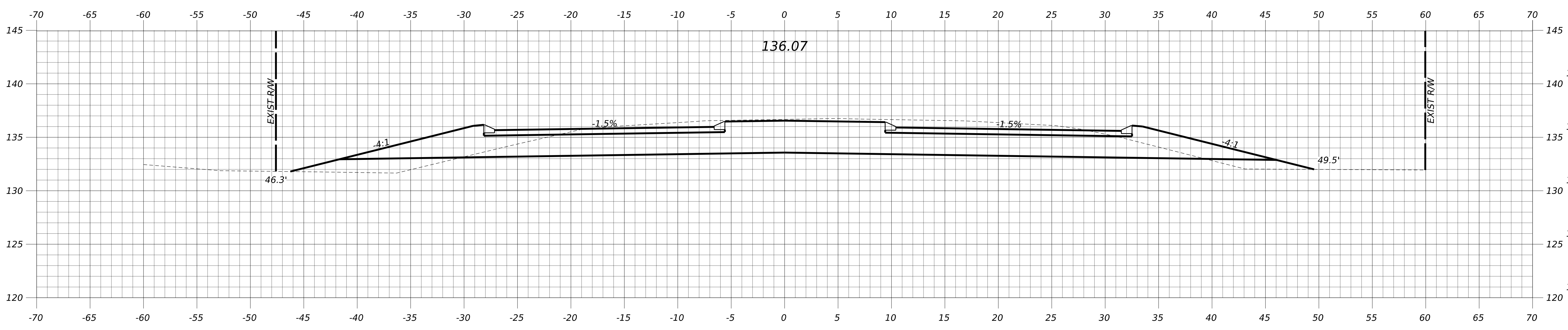

13+25.00

STATE OF MAINE
DEPARTMENT OF TRANSPORTATION

PROJ. M-N-NGER	BY	D-TE	SIGNATURE	P.E. NUMBER	DATE
DESIGN-DET-LED					
CHECKED-REVIEWED					
DESIGN-DET-LED					
DESIGN-DET-LED					
REVISIONS 1					
REVISIONS 2					
REVISIONS 3					
REVISIONS 4					
FIELD CHANGES					

WARREN
ROUTE 90 AT WESTERN RD
CROSS SECTIONS

SHEET NUMBER
45
OF 64

WIN 27036.00
HIGHWAY PLANS

Date: 2005/09/07

Username: \$user\$

Division:

Filename: c:\pw_pl\strongwa\44321790\040_cross_sections.dgn

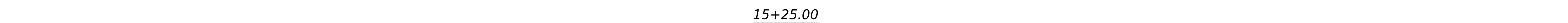
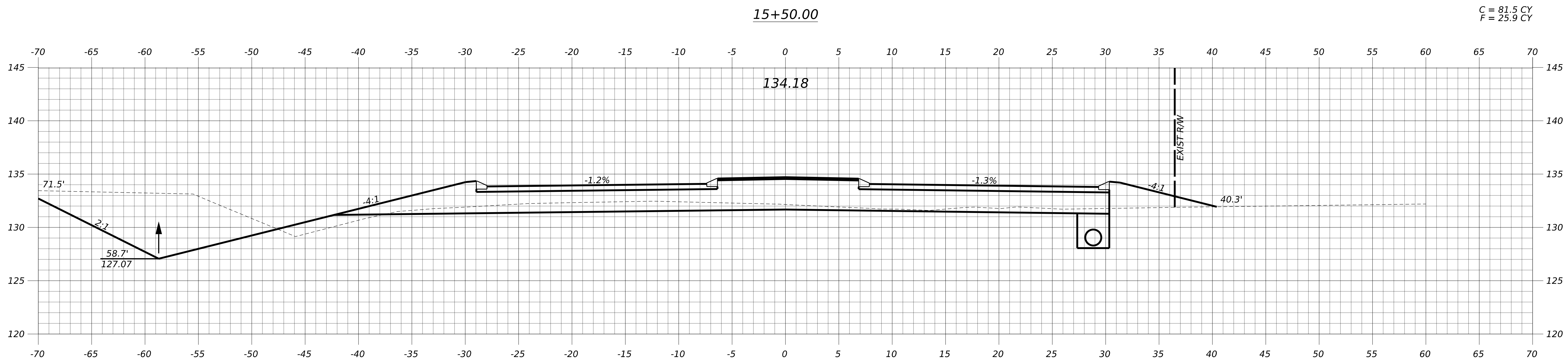
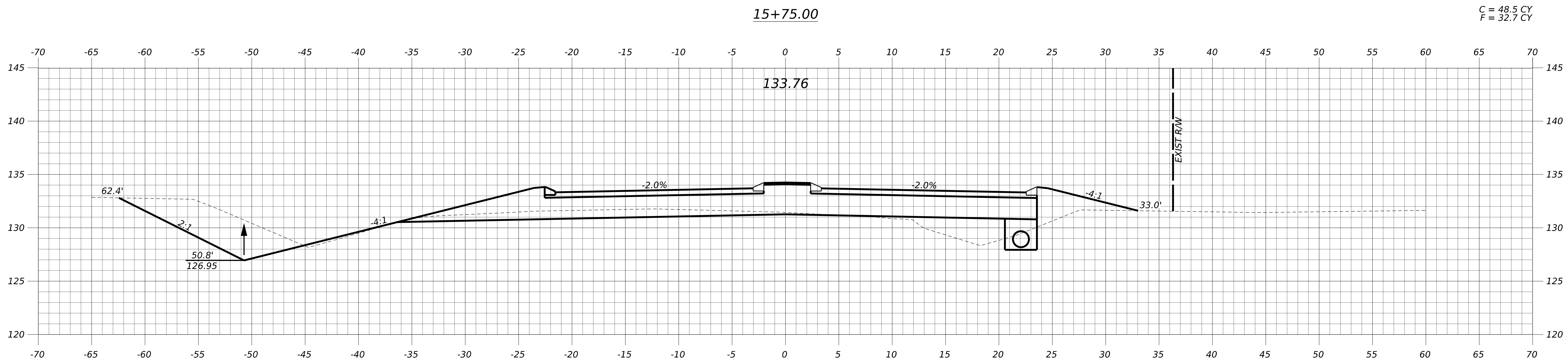
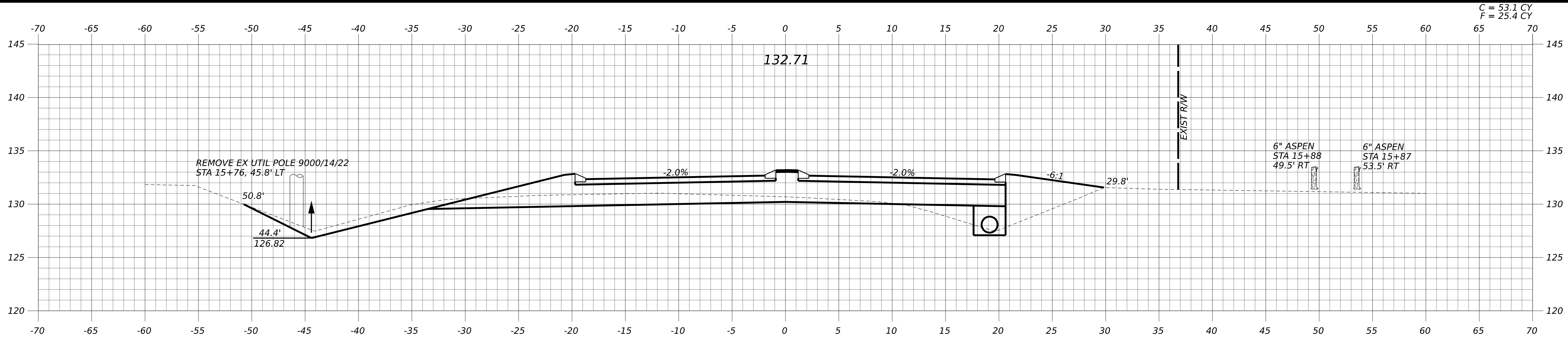

STATE OF MAINE
DEPARTMENT OF TRANSPORTATION

SIGNATURE

P.E. NUMBER

DATE

PROJ. M-N-GER

DESIGN-DET-LED

CHECKED-REVISED

DESIGN-DET-LED

DESIGN-DET-LED

REVISIONS 1

REVISIONS 2

REVISIONS 3

REVISIONS 4

FIELD CHANGES

WARREN
ROUTE 90 AT WESTERN RD

CROSS SECTIONS

SHEET NUMBER

46

OF 64

WIN
27036.00

HIGHWAY PLANS

Date: 2005/09/07

Username: \$user\$

Division:

Filename: c:\pw_pit\strongwa\44321790\040_cross_sections.dgn

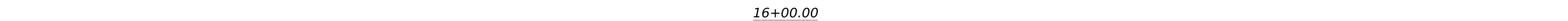
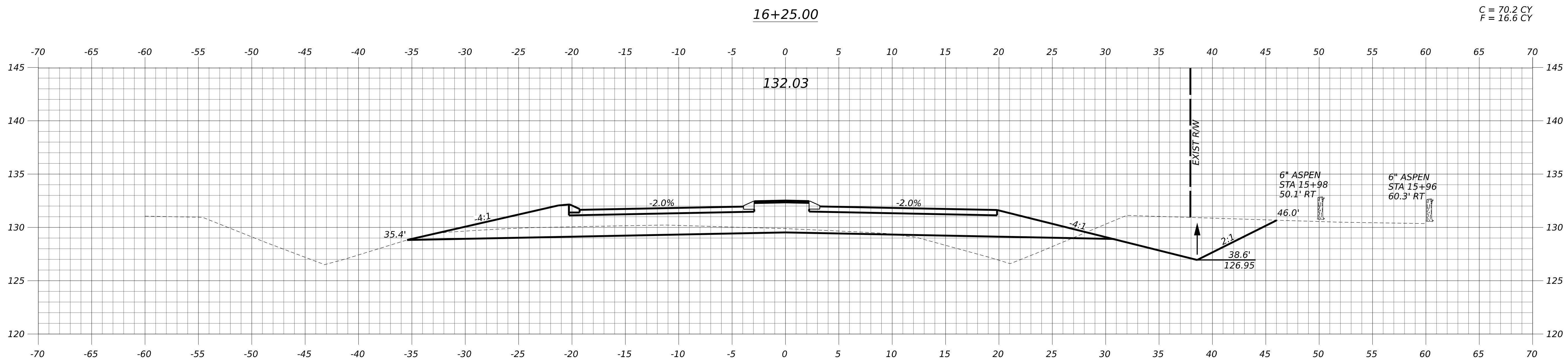
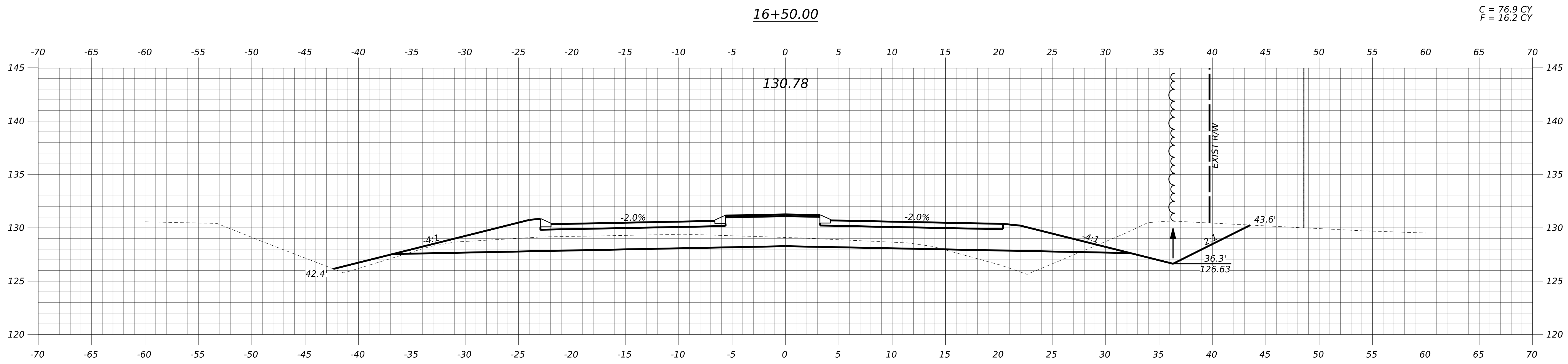
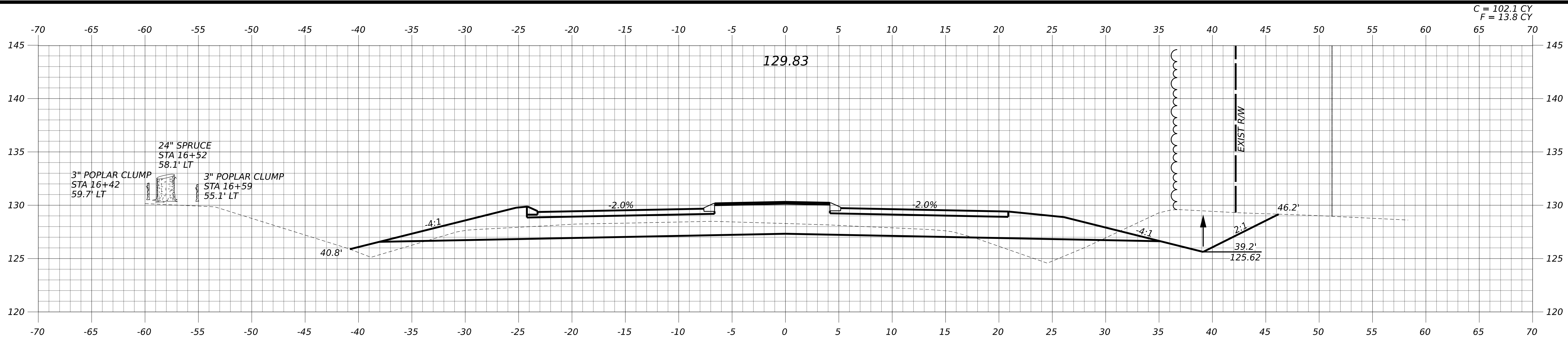

STATE OF MAINE
DEPARTMENT OF TRANSPORTATION

WARREN
ROUTE 90 AT WESTERN RD

CROSS SECTIONS

SHEET NUMBER
47
OF 64

WIN
27036.00
HIGHWAY PLANS

PROJ. MANAGER	DATE	BY	DATE	SIGNATURE	P.E. NUMBER	DATE
DESIGN-DETAILED						
CHECKED-REVIEWED						
DESIGN-DETAILED						
DESIGN-DETAILED						
REVISIONS 1						
REVISIONS 2						
REVISIONS 3						
REVISIONS 4						
FIELD CHANGES						

Date: 2005/09/07

Username: \$user\$

Division:

Filename: c:\pw_pl\strongwa\4321790\040_cross_sections.dgn

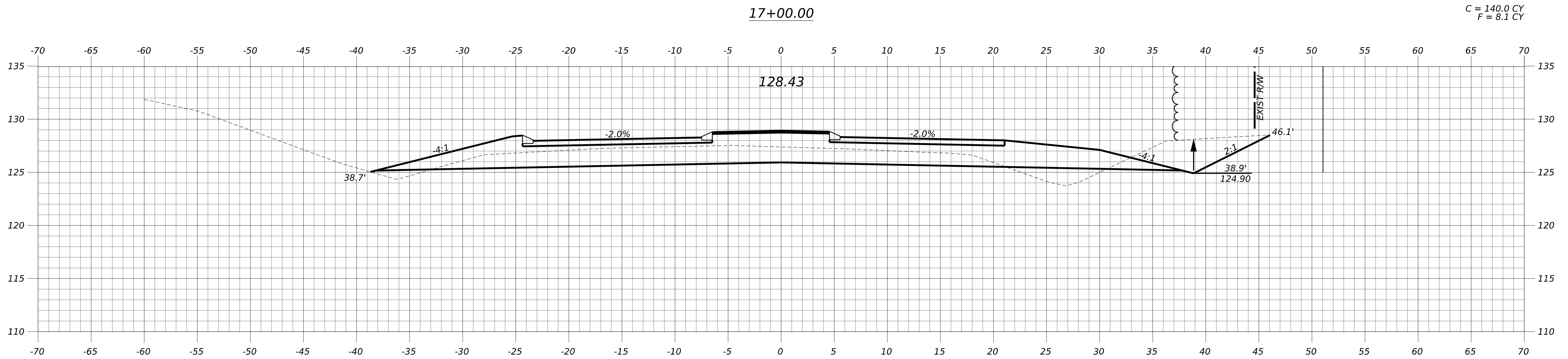
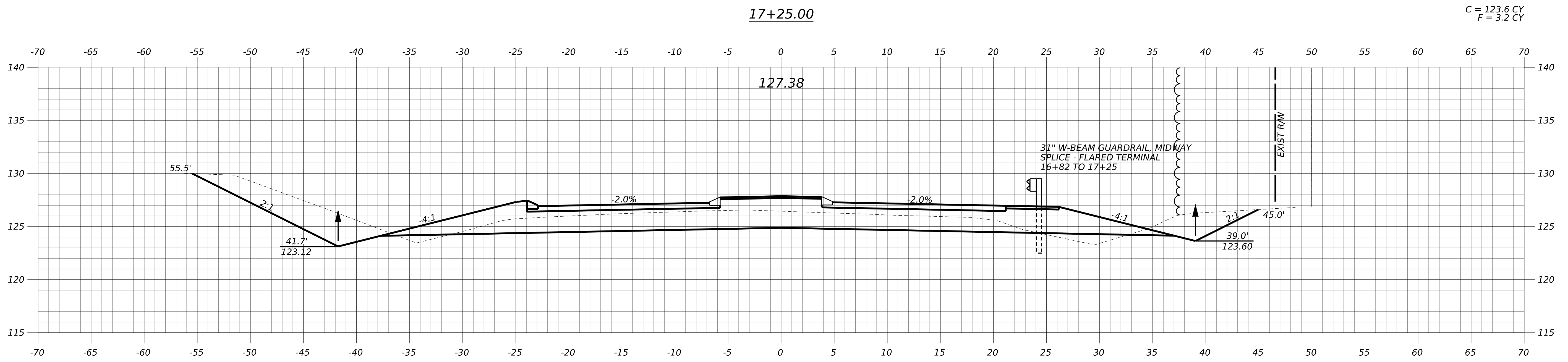
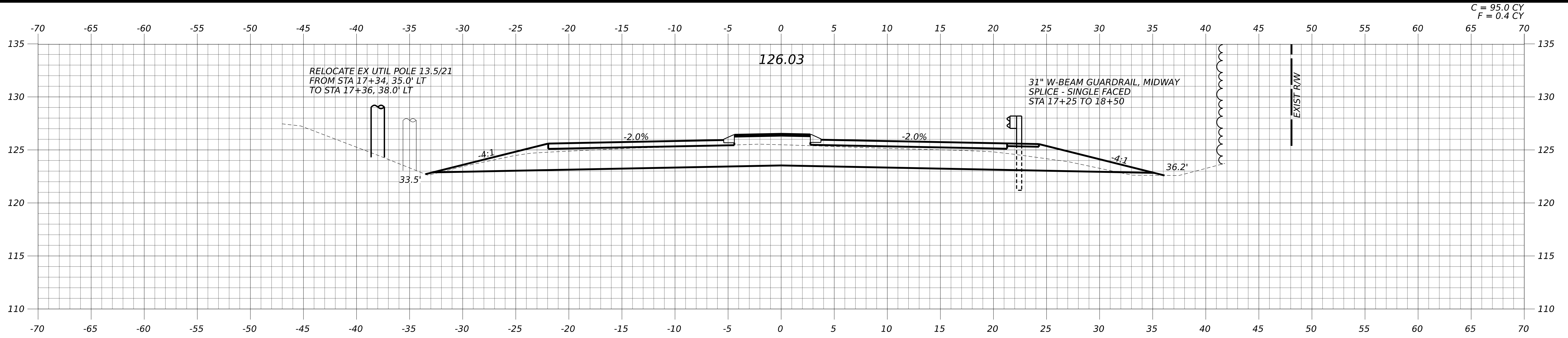

STATE OF MAINE
DEPARTMENT OF TRANSPORTATION

WIN
27036.00
HIGHWAY PLANS

PROJ. MANAGER	DATE	BY	DATE
DESIGN-DETAILED			
CHECKED-REVIEWED			
DESIGN-DETAILED			
DESIGN-DETAILED			
REVISIONS 1			
REVISIONS 2			
REVISIONS 3			
REVISIONS 4			
FIELD CHANGES			

WARREN
ROUTE 90 AT WESTERN RD

CROSS SECTIONS

SHEET NUMBER

48

OF 64

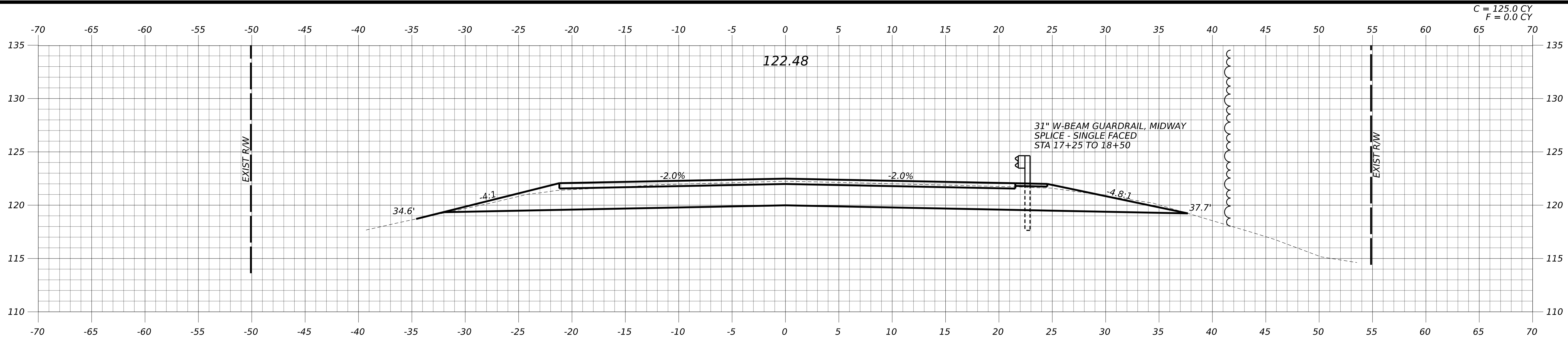

18+00.00 - END PROJECT

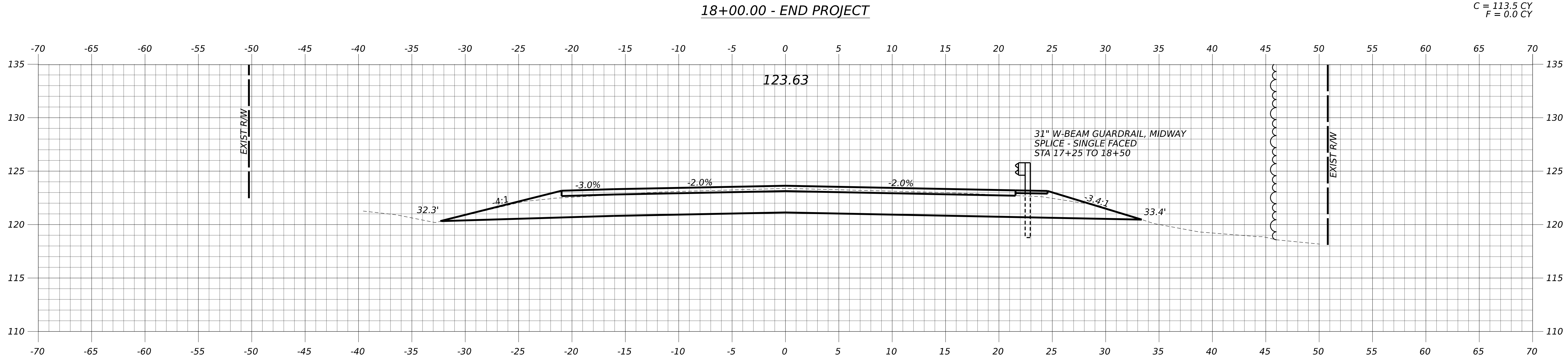

17+75.00

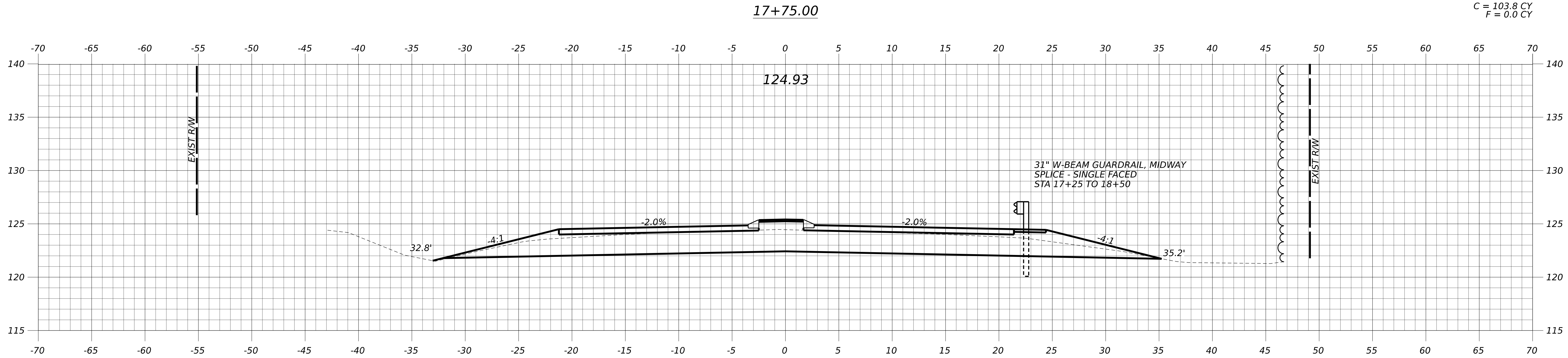

17+50.00

PROJ. M-N-GER	BY	D-TE	SIGNATURE	P.E. NUMBER	DATE
DESIGN-DET-LED					
CHECKED-REVIEWED					
DESIGN-DET-LED					
DESIGN-DET-LED					
REVISIONS 1					
REVISIONS 2					
REVISIONS 3					
REVISIONS 4					
FIELD CHANGES					

WARREN
ROUTE 90 AT WESTERN RD

CROSS SECTIONS

SHEET NUMBER

49

OF 64

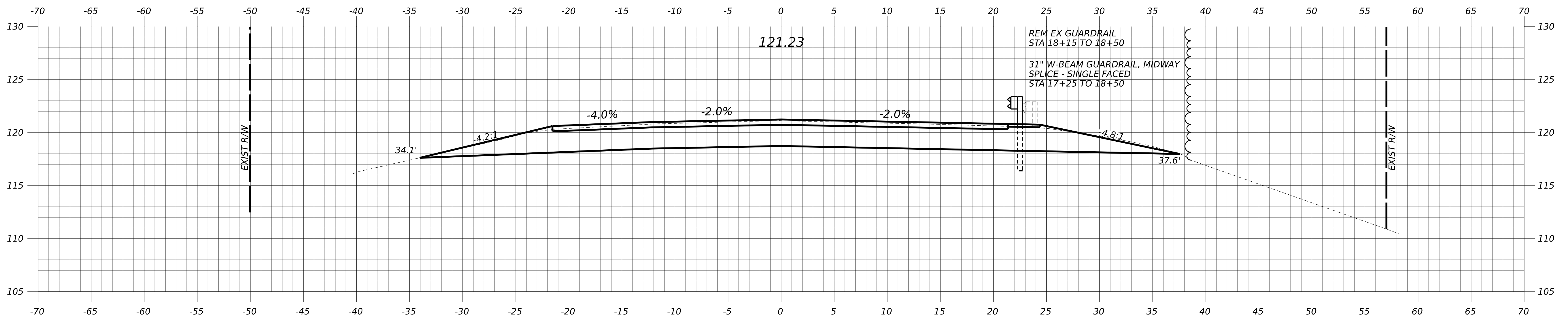
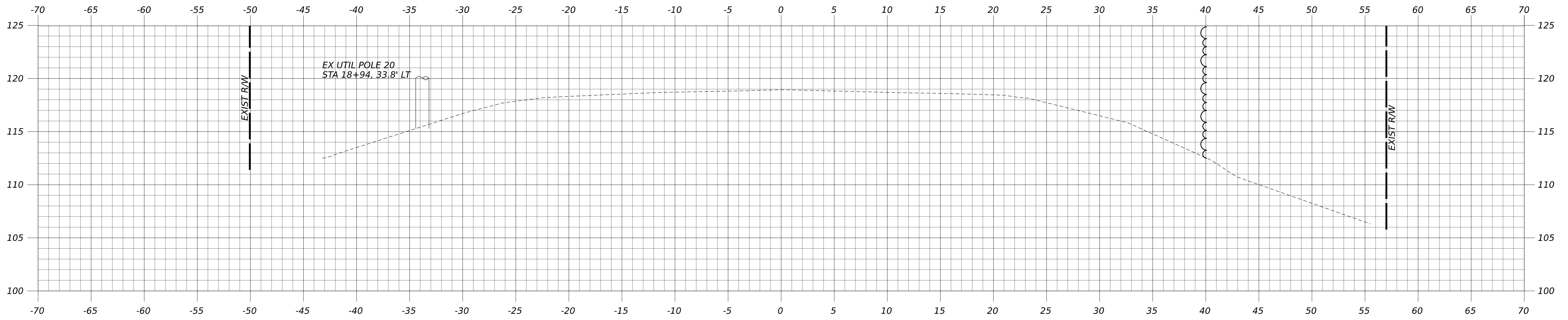

Date: 2005/09/07

Username: \$user\$

Division:

Filename: c:\pw_pit\strongwa\4321790\040_cross_sections.dgn

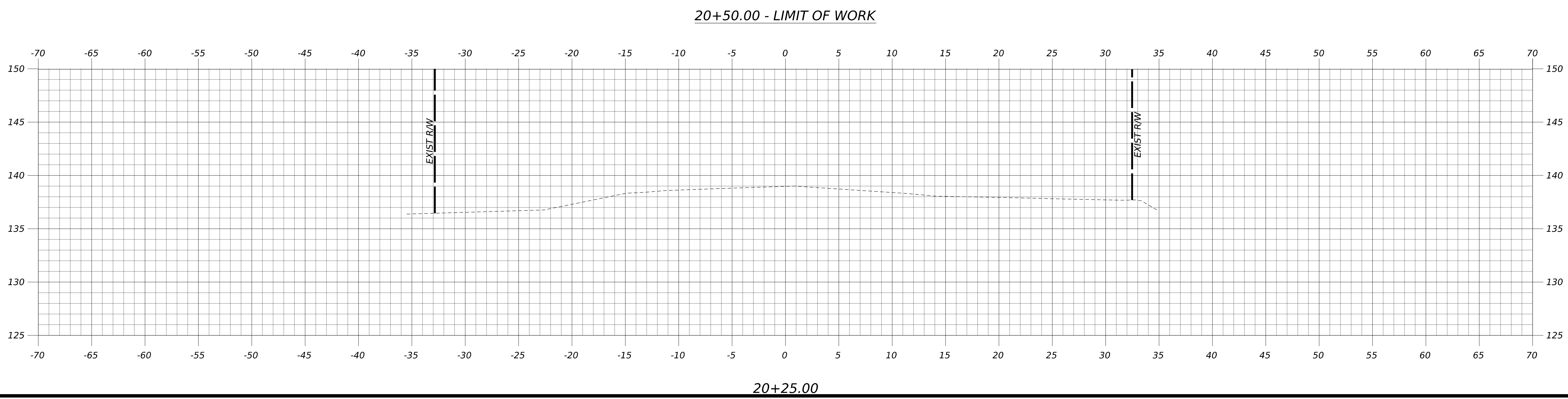
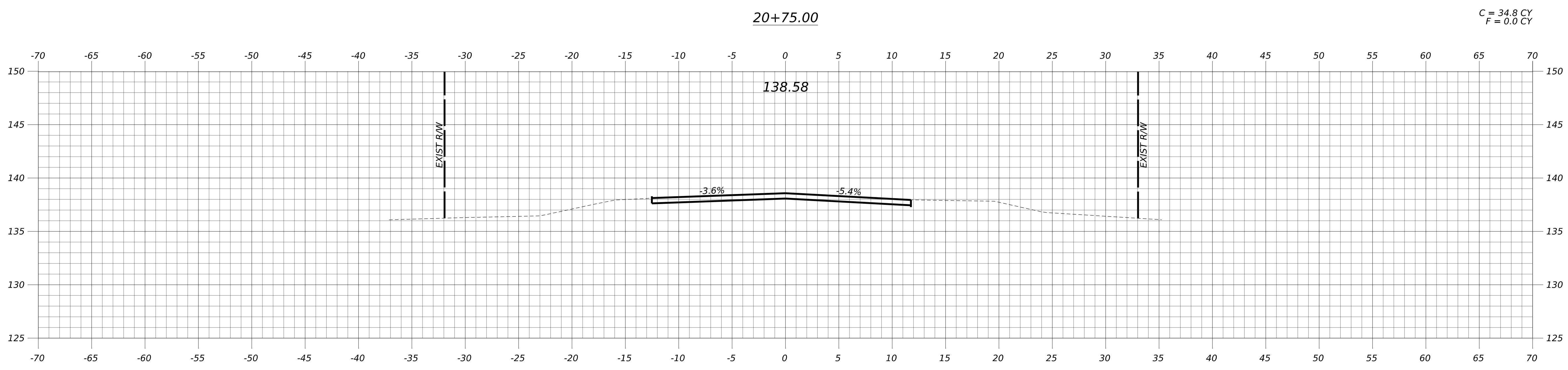
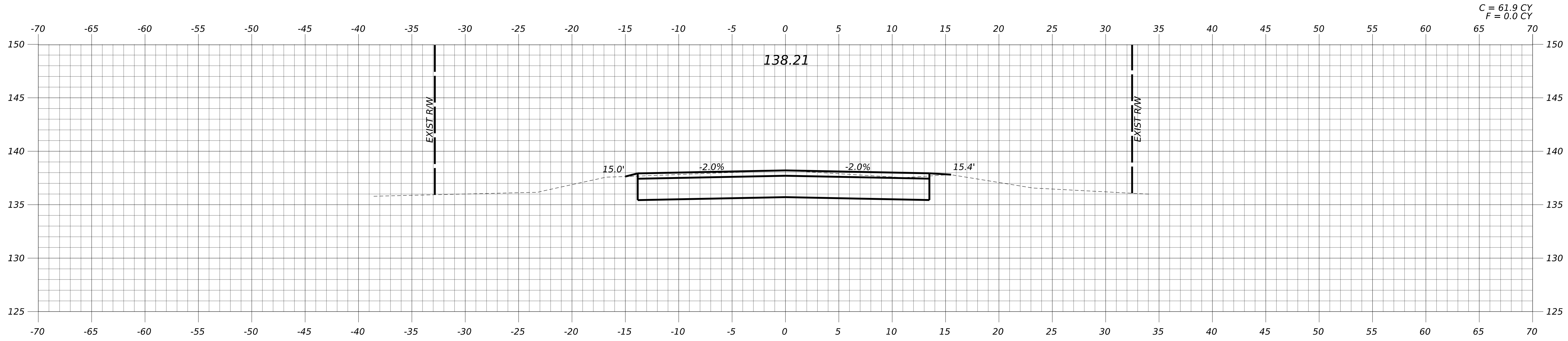

STATE OF MAINE
DEPARTMENT OF TRANSPORTATION

WIN
27036.00
HIGHWAY PLANS

PROJ. M-N-GER	BY	D-TE	SIGNATURE	P.E. NUMBER	DATE
DESIGN-DET-LED					
CHECKED-REVIEWED					
DESIGN-DET-LED					
DESIGN-DET-LED					
REVISIONS 1					
REVISIONS 2					
REVISIONS 3					
REVISIONS 4					
FIELD CHANGES					

WARREN
ROUTE 90 AT WESTERN RD
CROSS SECTIONS

SHEET NUMBER
51
OF 64

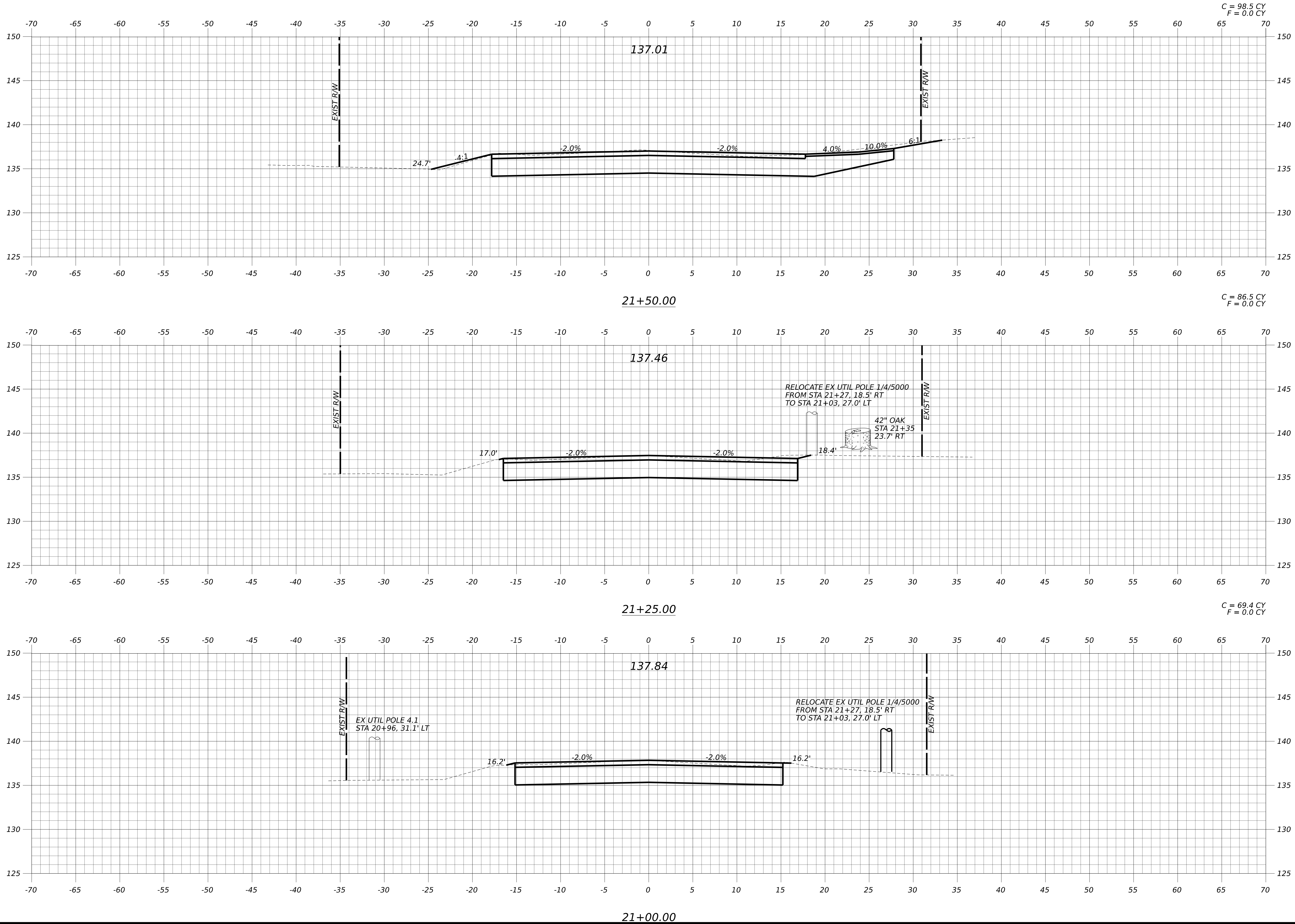

STATE OF MAINE
DEPARTMENT OF TRANSPORTATION

WIN
27036.00
HIGHWAY PLANS

PROJ. M-N-GER	D-TE	BY	SIGNATURE	P.E. NUMBER	DATE
DESIGN-DET-LED					
CHECKED-REV-LED					
DESIGN-DET-LED					
DESIGN-DET-LED					
REVISIONS 1					
REVISIONS 2					
REVISIONS 3					
REVISIONS 4					
FIELD CHANGES					

WARREN
ROUTE 90 AT WESTERN RD
CROSS SECTIONS

SHEET NUMBER

52

OF 64

Date: 2005/09/07

Username: \$user\$

Division:

Filename: c:\pw_pit\strongwa\4321790\040_cross_sections.dgn

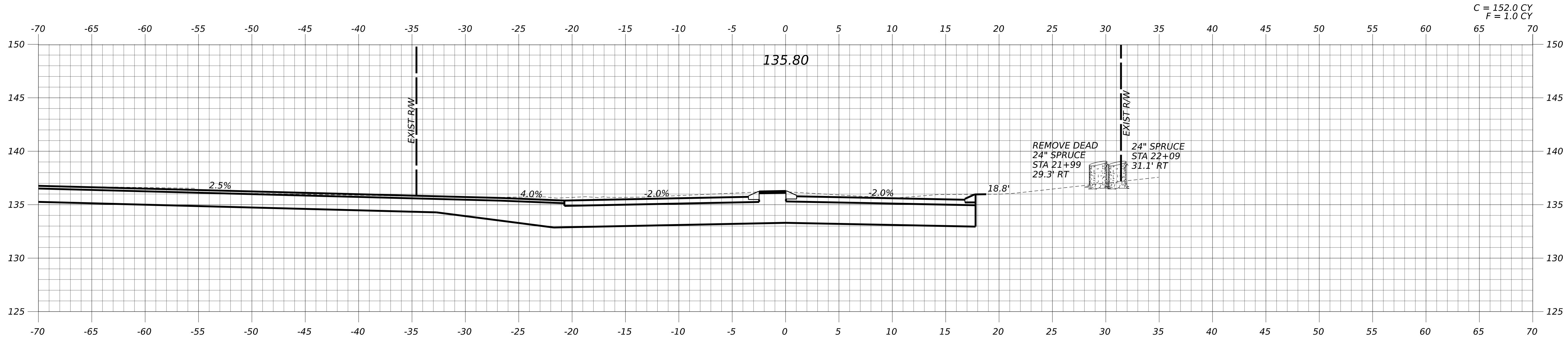

135.80

C = 152.0 CY
F = 1.0 CY

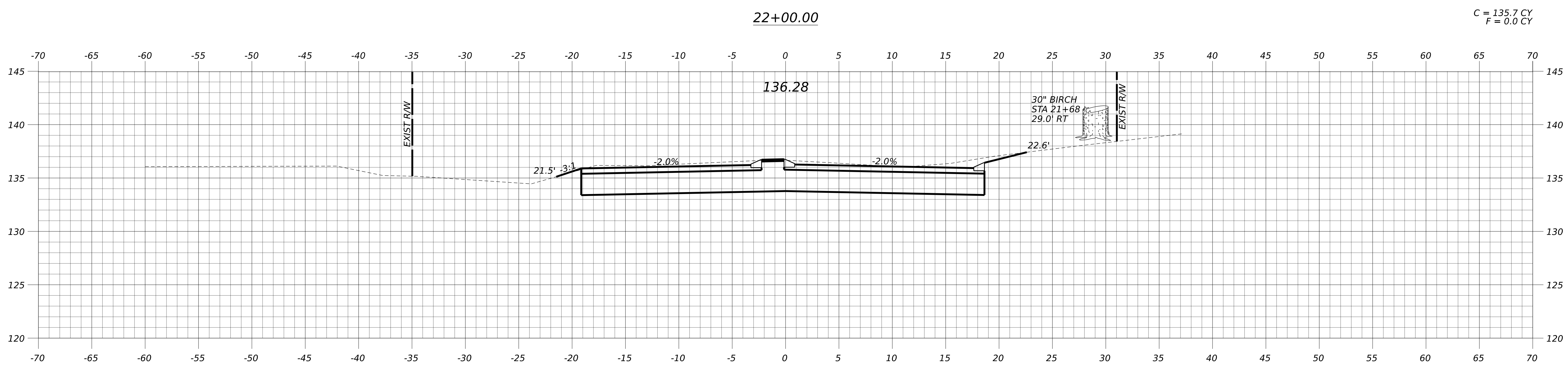

22+00.00

C = 135.7 CY
F = 0.0 CY

136.28

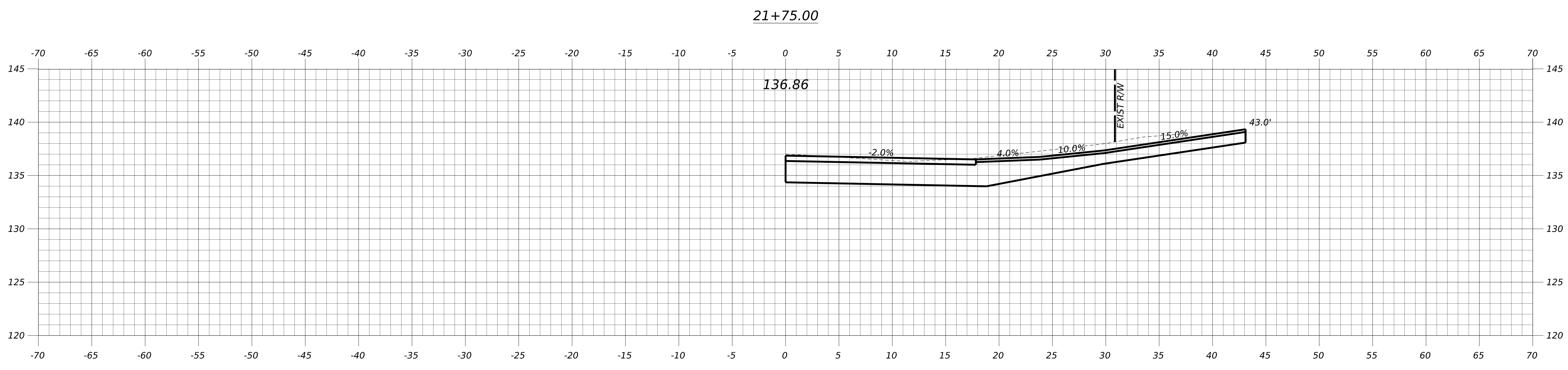

21+75.00

136.86

21+55.00 - DRIVEWAY RT

STATE OF MAINE
DEPARTMENT OF TRANSPORTATION

WIN
27036.00
HIGHWAY PLANS

PROJ. M-N-GER	BY	D-TE	SIGNATURE	P.E. NUMBER	DATE
DESIGN-DET-LED					
CHECKED-REVIEWED					
DESIGN-DET-LED					
DESIGN-DET-LED					
REVISIONS 1					
REVISIONS 2					
REVISIONS 3					
REVISIONS 4					
FIELD CHANGES					

WARREN
ROUTE 90 AT WESTERN RD
CROSS SECTIONS

SHEET NUMBER
53
OF 64

Date: 2005/09/07

Username: \$user\$

Division:

Filename: c:\pw_pit\strongwa\4321790\040_cross_sections.dgn

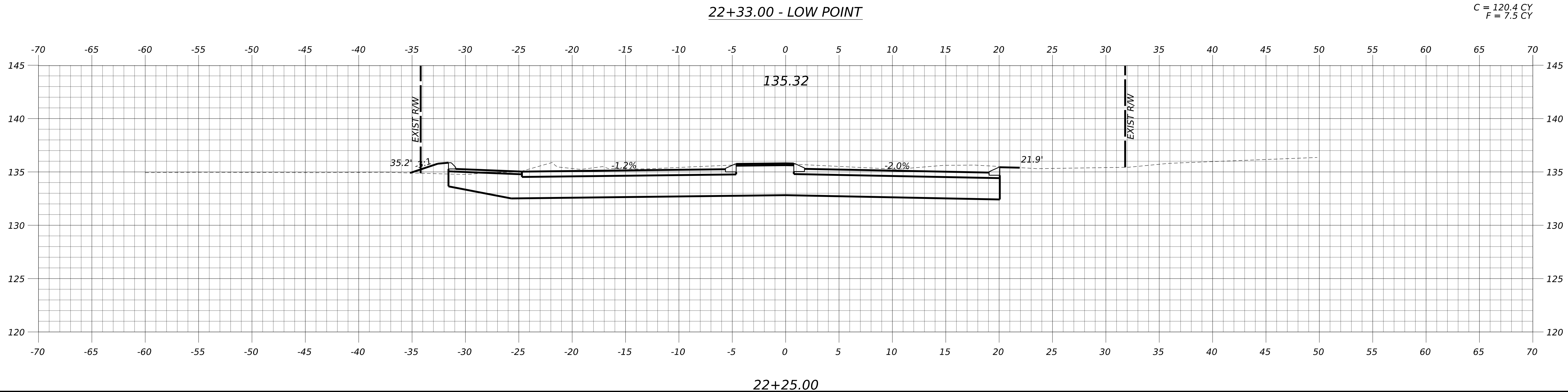
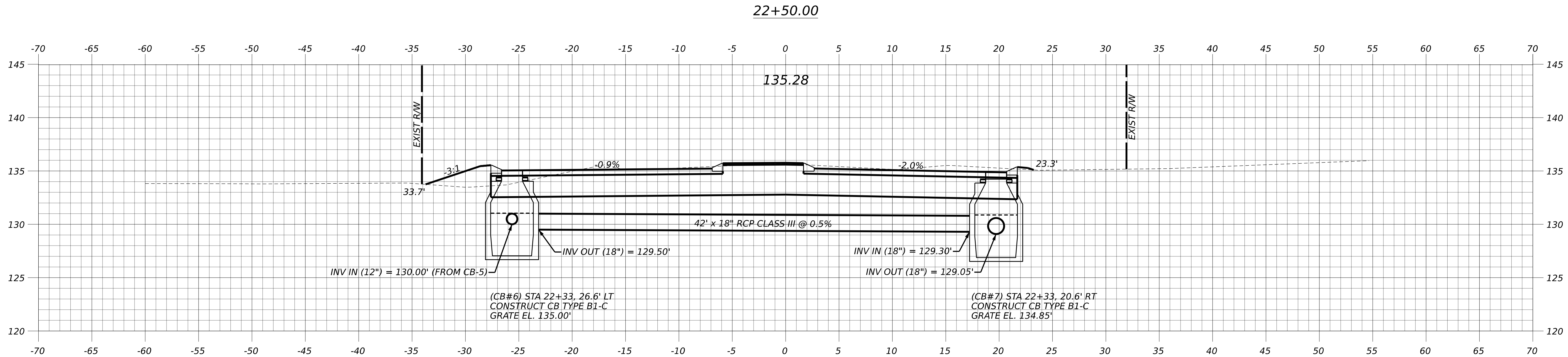
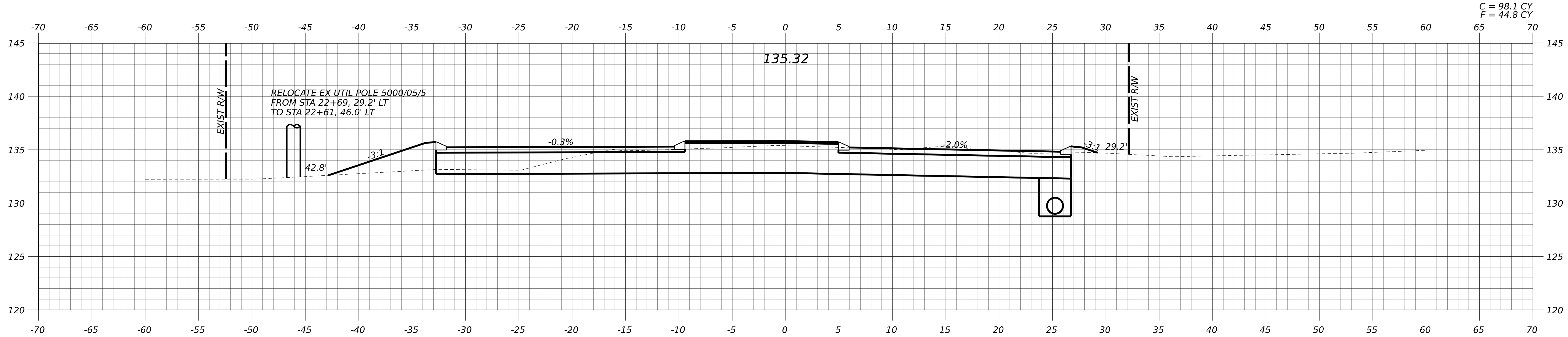

STATE OF MAINE
DEPARTMENT OF TRANSPORTATION

WIN
27036.00
HIGHWAY PLANS

PROJ. M-N-GER	BY	D-TE	SIGNATURE	P.E. NUMBER	DATE
DESIGN-DET-LED					
CHECKED-REV-LED					
DESIGN-DET-LED					
DESIGN-DET-LED					
REVISIONS 1					
REVISIONS 2					
REVISIONS 3					
REVISIONS 4					
FIELD CHANGES					

WARREN
ROUTE 90 AT WESTERN RD
CROSS SECTIONS

SHEET NUMBER

54

OF 64

Date: 2005/09/07

Username: \$user\$

Division:

Filename: c:\pw_pit\strongwa\4321790\040_cross_sections.dgn

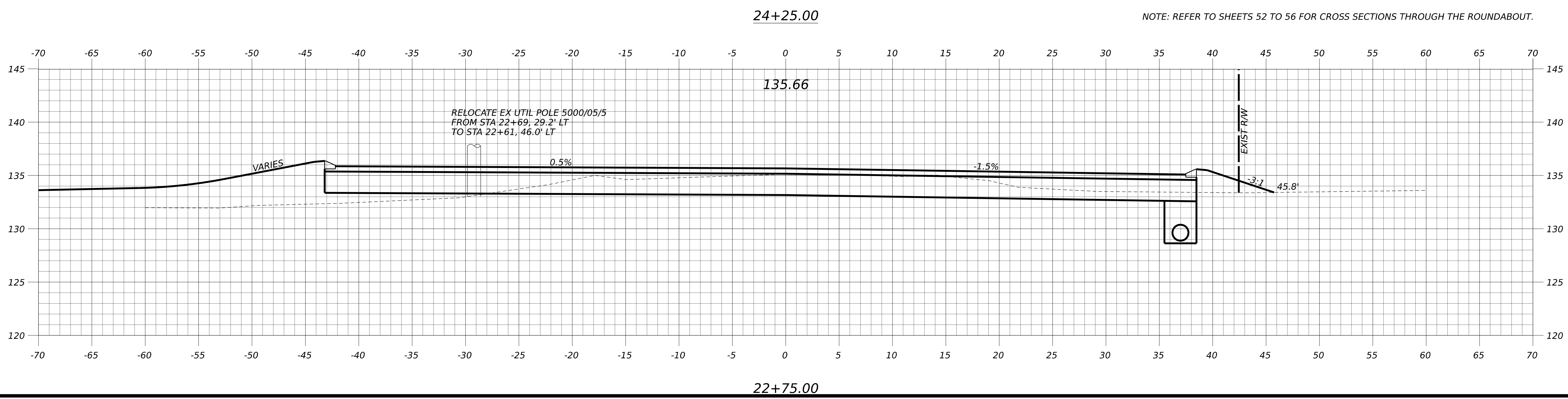
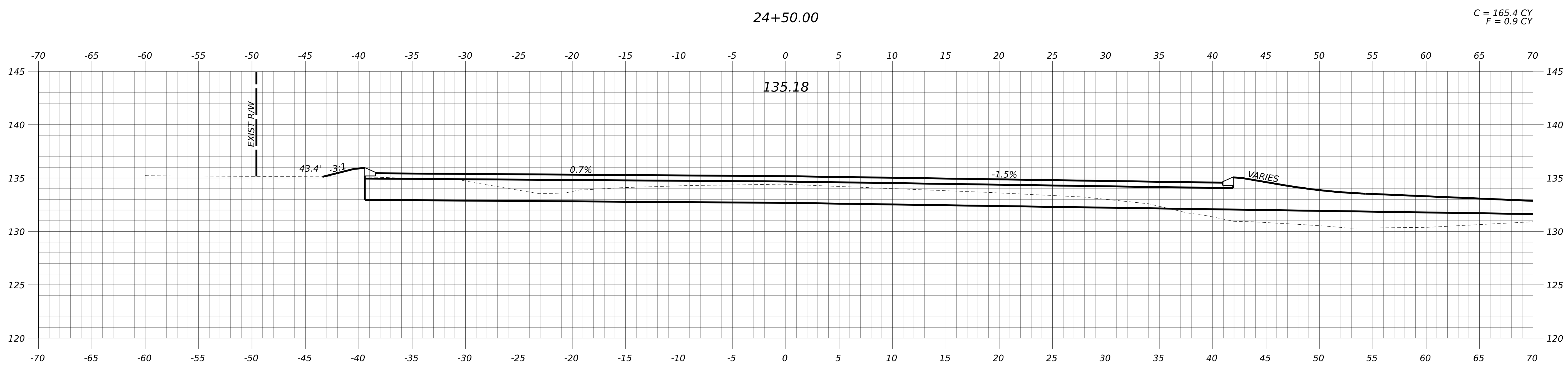

STATE OF MAINE
DEPARTMENT OF TRANSPORTATION

PROJ. M-N-GR	BY	D-T-E	SIGNATURE	P.E. NUMBER	DATE
DESIGN-DET-LED					
CHECKED-REVIED					
DESIGN-DET-LED					
DESIGN-DET-LED					
REVISIONS 1					
REVISIONS 2					
REVISIONS 3					
REVISIONS 4					
FIELD CHANGES					

WARREN
ROUTE 90 AT WESTERN RD
CROSS SECTIONS

SHEET NUMBER
55
OF 64

WIN
27036.00
HIGHWAY PLANS

Date: 2005/09/07

Username: \$user\$

Division:

Filename: c:\pw_pit\strongwa\4321790\040_cross_sections.dgn

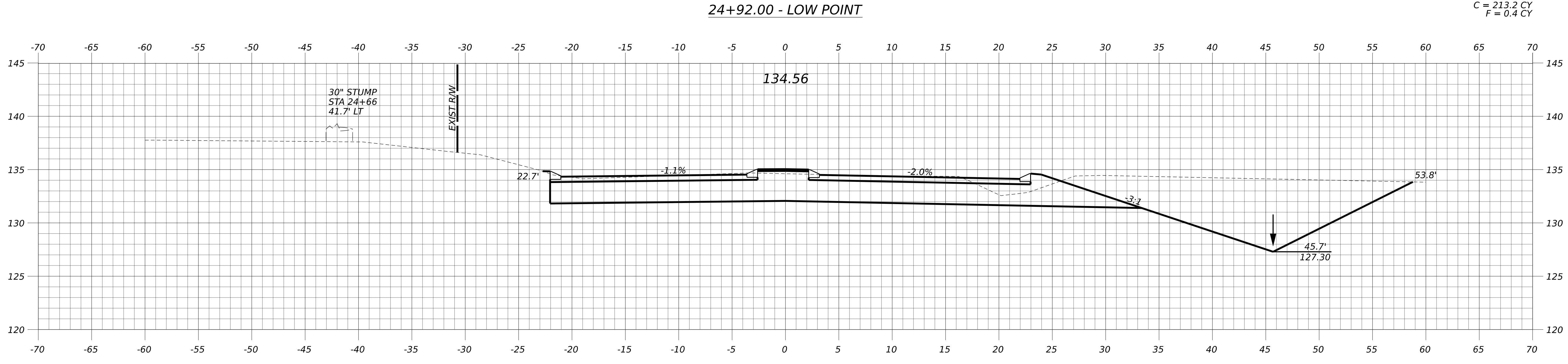
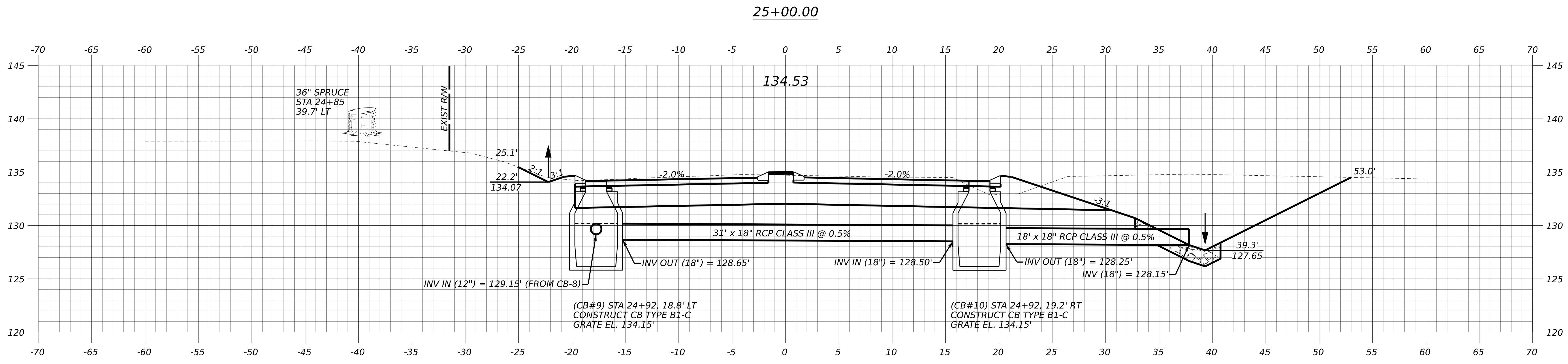
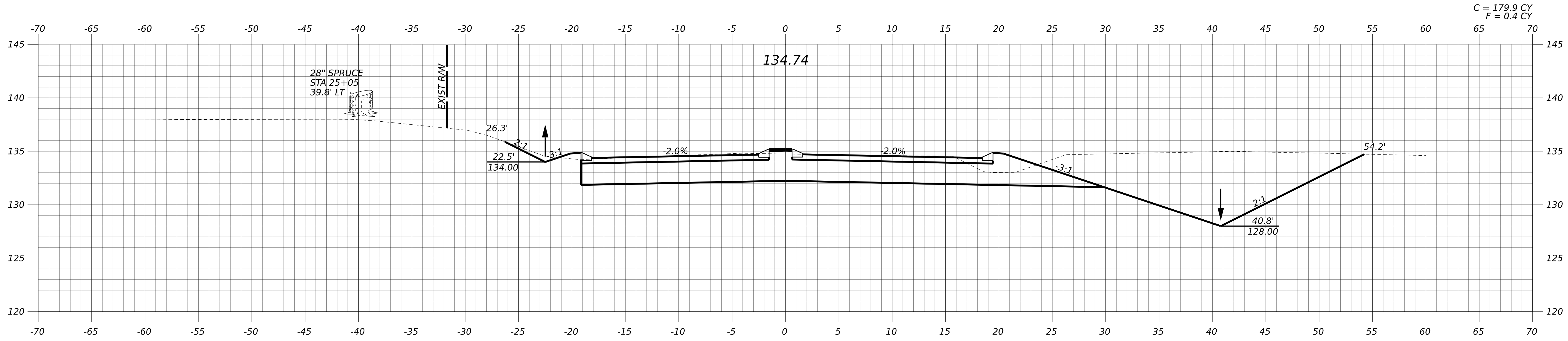

C = 179.9 CY
F = 0.4 CY

C = 213.2 CY
F = 0.4 CY

STATE OF MAINE
DEPARTMENT OF TRANSPORTATION

PROJ. MANAGER	DATE	BY	DATE	SIGNATURE	P.E. NUMBER	DATE
DESIGN-DETAILED						
CHECKED-REVIEWED						
DESIGN-DETAILED						
REVISIONS 1						
REVISIONS 2						
REVISIONS 3						
REVISIONS 4						
FIELD CHANGES						

WARREN
ROUTE 90 AT WESTERN RD

CROSS SECTIONS

SHEET NUMBER
56
OF 64

WIN
27036.00
HIGHWAY PLANS

Date: 2005/09/07

Username: \$user\$

Division:

Filename: c:\pw_pit\strongwa\44321790\040_cross_sections.dgn

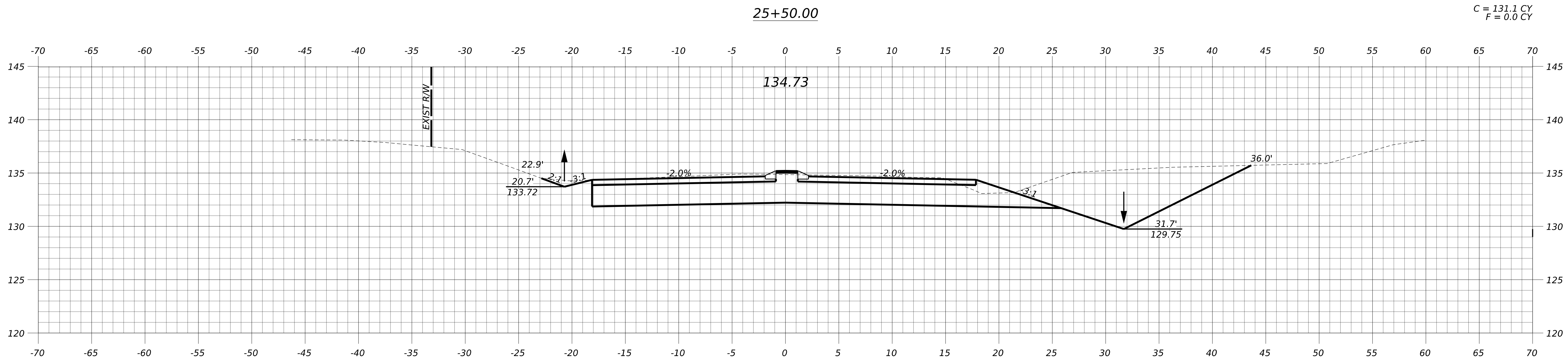
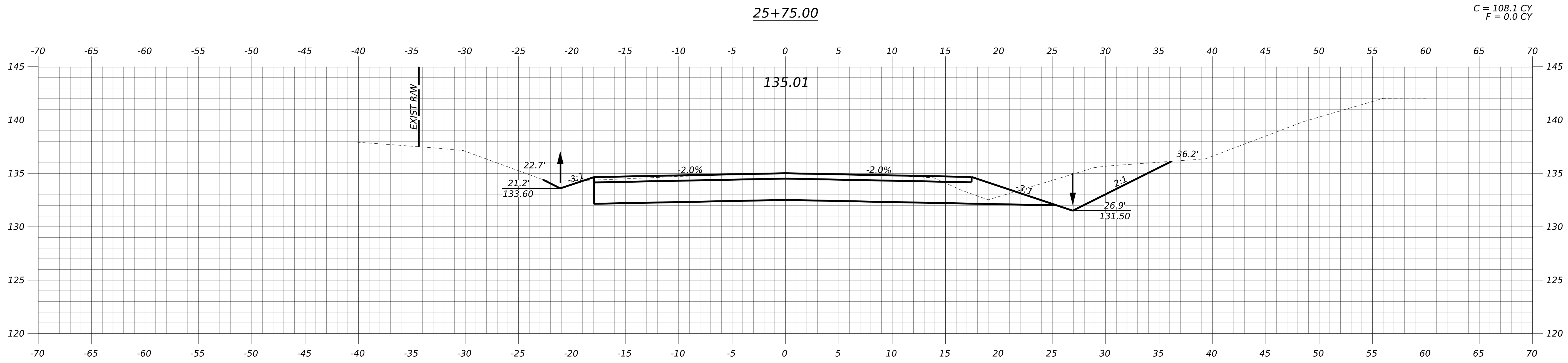
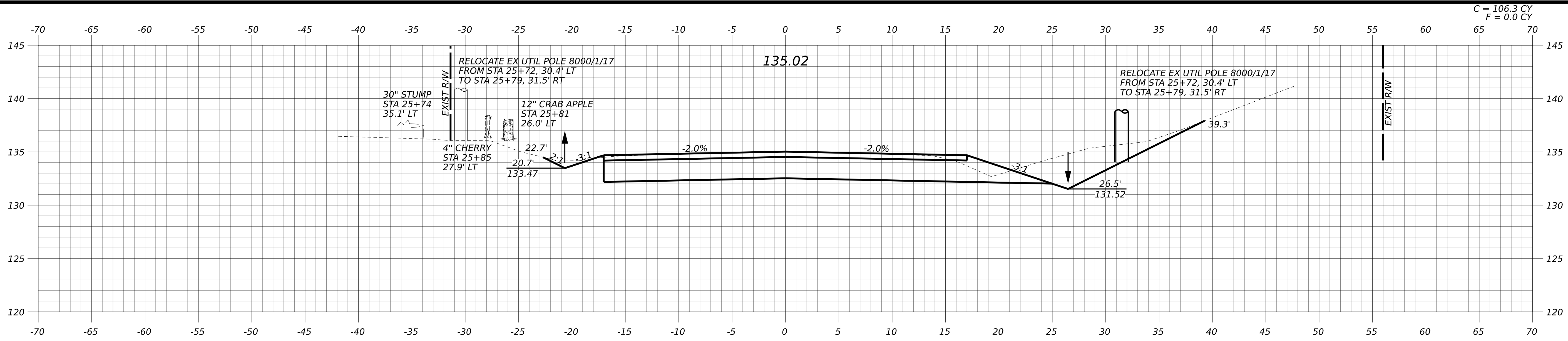

STATE OF MAINE
DEPARTMENT OF TRANSPORTATION

PROJ. MANAGER	DATE	BY	SIGNATURE
DESIGN-DETAILED			
CHECKED-REVIEWED			
DESIGN-DETAILED			
DESIGN-DETAILED			
REVISIONS 1			
REVISIONS 2			
REVISIONS 3			
REVISIONS 4			
FIELD CHANGES			

WARREN
ROUTE 90 AT WESTERN RD

CROSS SECTIONS

SHEET NUMBER

57

OF 64

WIN
27036.00

HIGHWAY PLANS

Date: 2005/09/07

Username: \$user\$

Division:

Filename: c:\pw_pl\strongwa\4321790\040_cross_sections.dgn

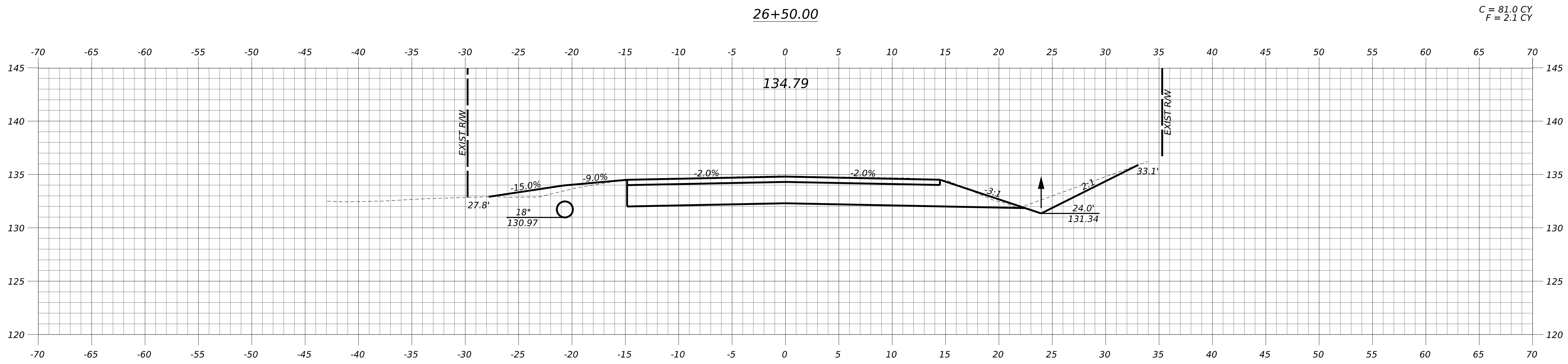
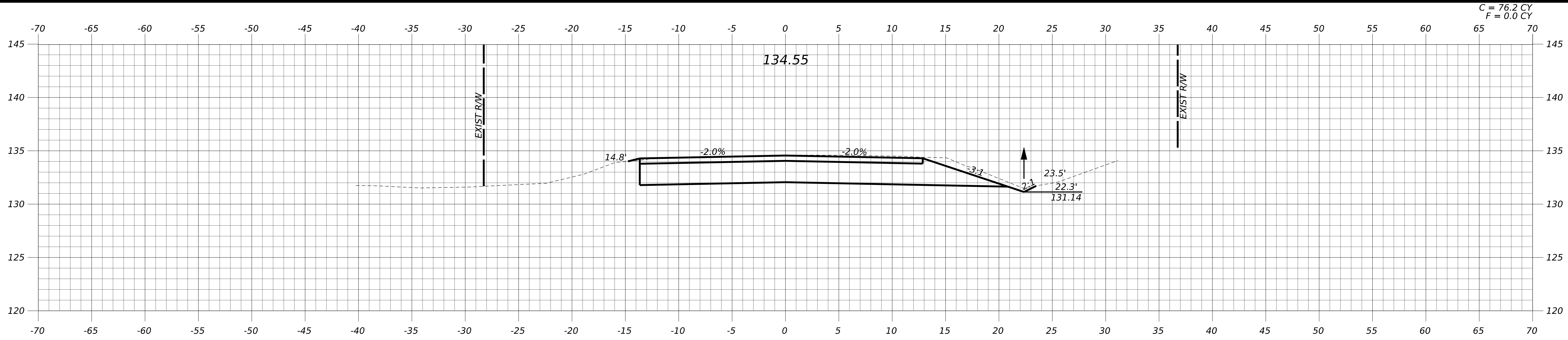

STATE OF MAINE
DEPARTMENT OF TRANSPORTATION

WIN
27036.00
HIGHWAY PLANS

PROJ. M-N-GER	BY	D-TE	SIGNATURE	P.E. NUMBER	DATE
DESIGN-DET-LED					
CHECKED-REVIEWED					
DESIGN-DET-LED					
DESIGN-DET-LED					
REVISIONS 1					
REVISIONS 2					
REVISIONS 3					
REVISIONS 4					
FIELD CHANGES					

WARREN
ROUTE 90 AT WESTERN RD
CROSS SECTIONS

SHEET NUMBER

58

OF 64

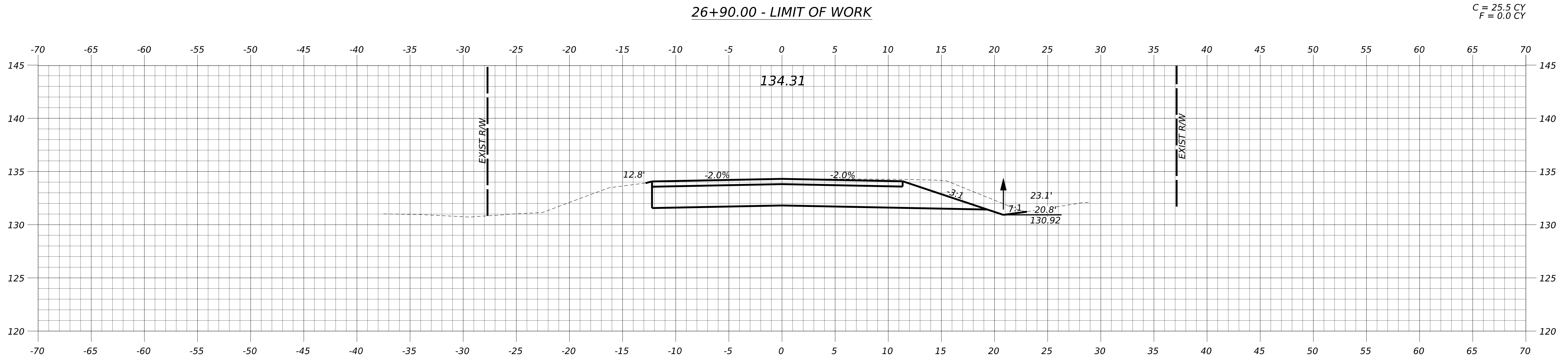
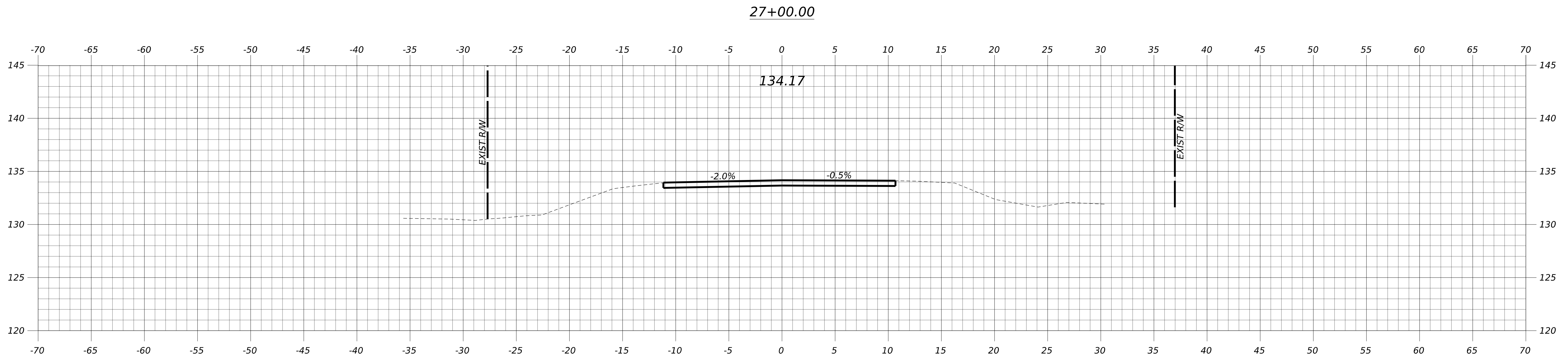
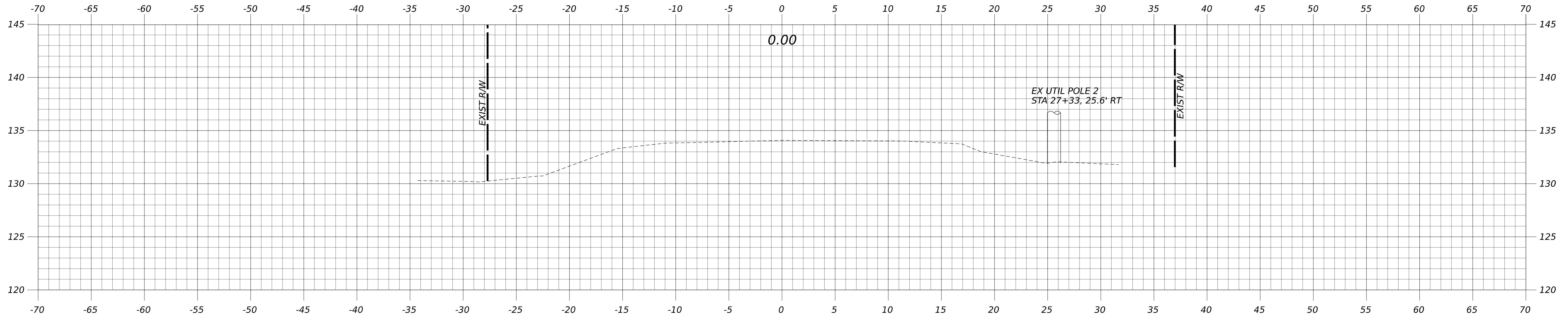

STATE OF MAINE
DEPARTMENT OF TRANSPORTATION

WIN
27036.00
HIGHWAY PLANS

PROJ. M-N-GER	BY	D-TE	SIGNATURE	P.E. NUMBER	DATE
DESIGN-DET-LED					
CHECKED-REVIEWED					
DESIGN-DET-LED					
DESIGN-DET-LED					
REVISIONS 1					
REVISIONS 2					
REVISIONS 3					
REVISIONS 4					
FIELD CHANGES					

**WARREN
ROUTE 90 AT WESTERN RD
CROSS SECTIONS**

SHEET NUMBER

59

OF 64

Date: 2005/09/07

Username: \$user\$

Division:

Filename: c:\pw_pl\strongwa\4321790\040_cross_sections.dgn

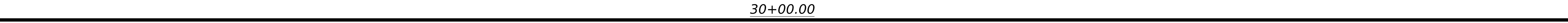
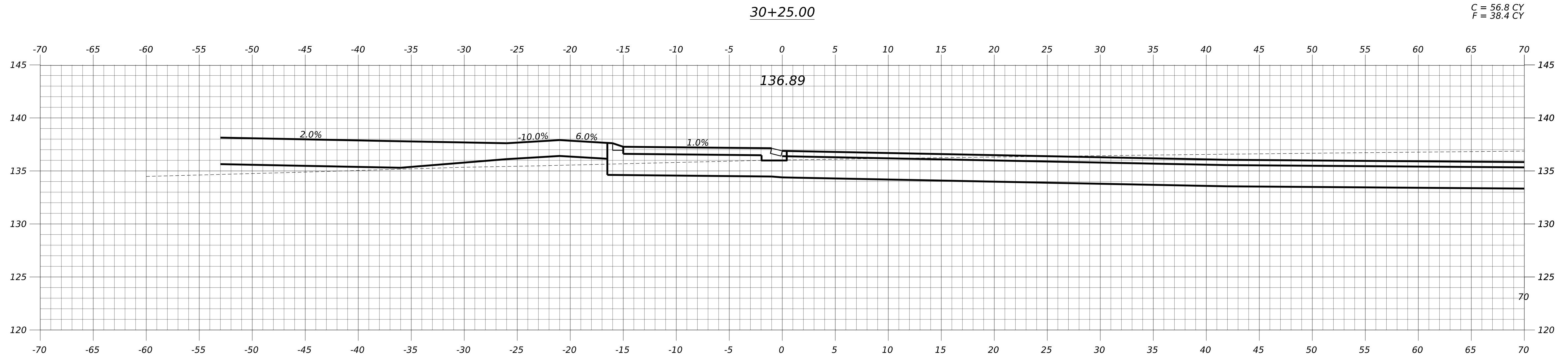
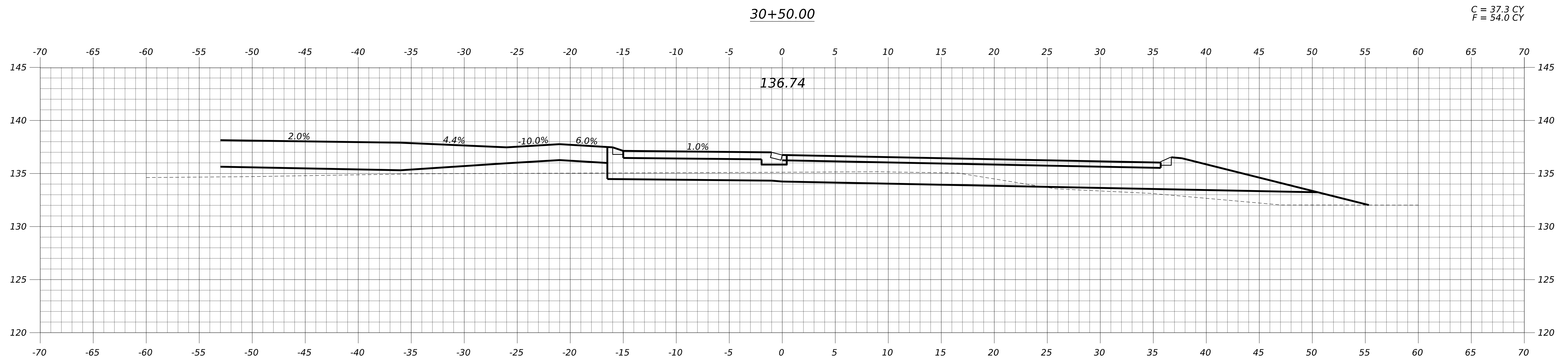
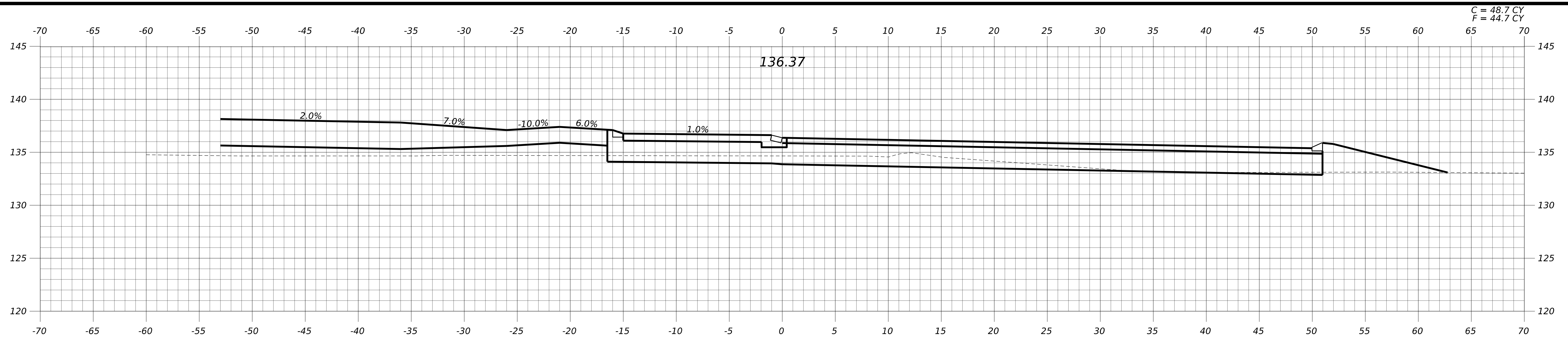

STATE OF MAINE
DEPARTMENT OF TRANSPORTATION

WIN
27036.00
HIGHWAY PLANS

PROJ. M-N-GER	D-TE	BY	SIGNATURE	P.E. NUMBER	DATE
DESIGN-DET-LED					
CHECKED-REVIEWED					
DESIGN-DET-LED					
DESIGN-DET-LED					
REVISIONS 1					
REVISIONS 2					
REVISIONS 3					
REVISIONS 4					
FIELD CHANGES					

WARREN
ROUTE 90 AT WESTERN RD
CROSS SECTIONS

SHEET NUMBER
60
OF 64

Date: 2005/09/07

Username: \$user\$

Division:

Filename: c:\pw_pi\strongwa\4321790\040_cross_sections.dgn

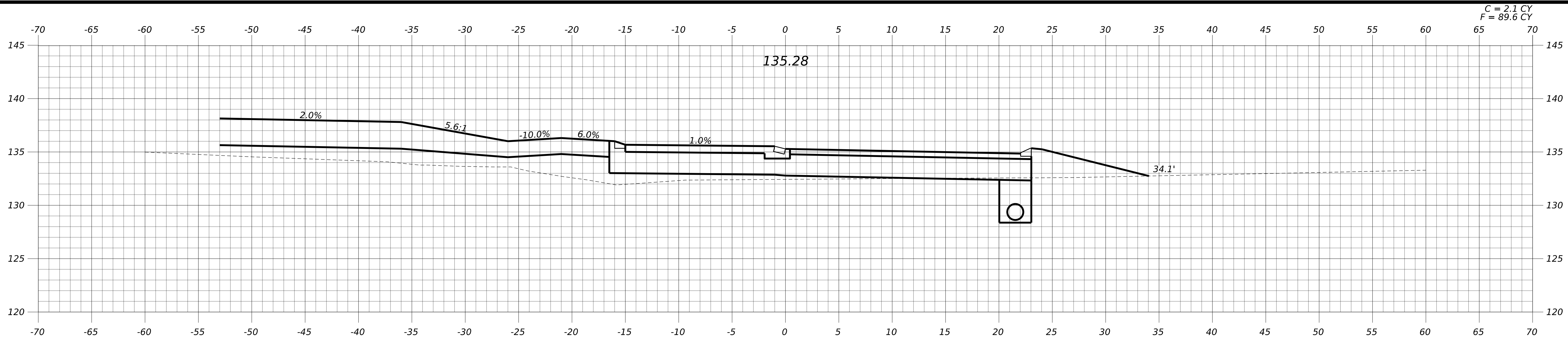

C = 2.1 CY
F = 89.6 CY

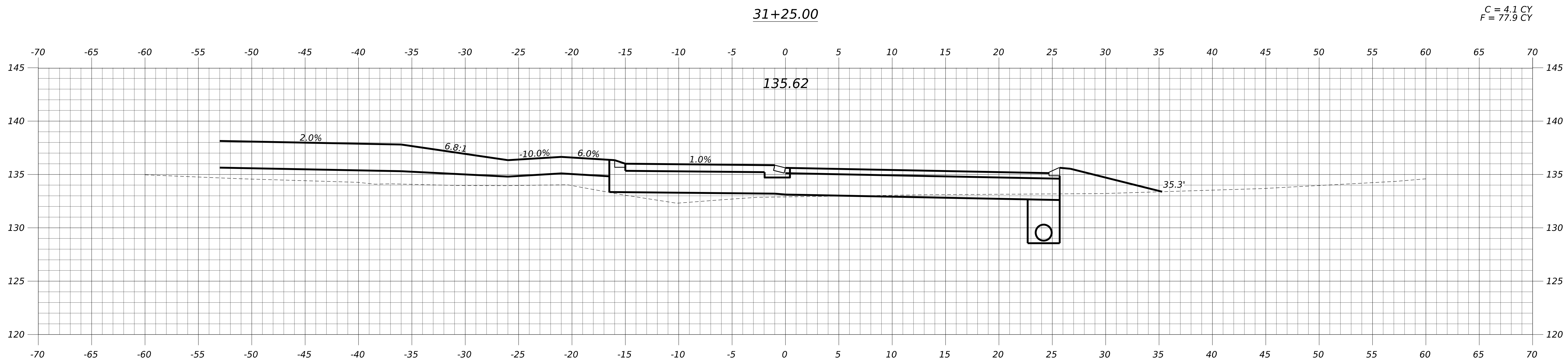

C = 4.1 CY
F = 77.9 CY

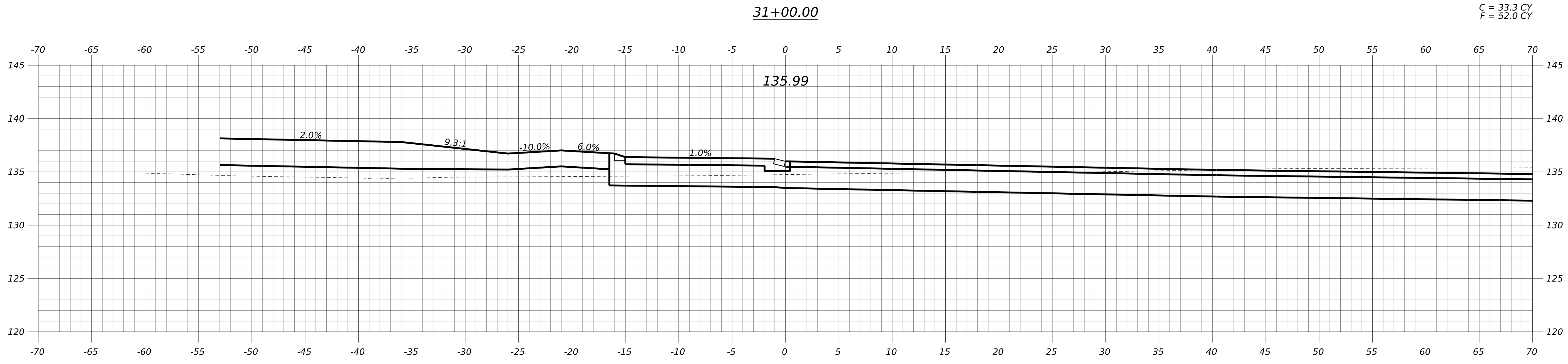

C = 33.3 CY
F = 52.0 CY

STATE OF MAINE
DEPARTMENT OF TRANSPORTATION

PROJ. M-N-GER	SIGNATURE
DESIGN-DET-LED	P.E. NUMBER
CHECKED-REVIEWED	DATE
DESIGN-DET-LEDS	
DESIGN-DET-LEDS	
REVISIONS 1	
REVISIONS 2	
REVISIONS 3	
REVISIONS 4	
FIELD CHANGES	

WARREN
ROUTE 90 AT WESTERN RD

CROSS SECTIONS

SHEET NUMBER
61
OF 64

WIN
27036.00
HIGHWAY PLANS

Date: 2005/09/07

Username: \$user\$

Division:

Filename: c:\pw_pi\strongwa\4321790\040_cross_sections.dgn

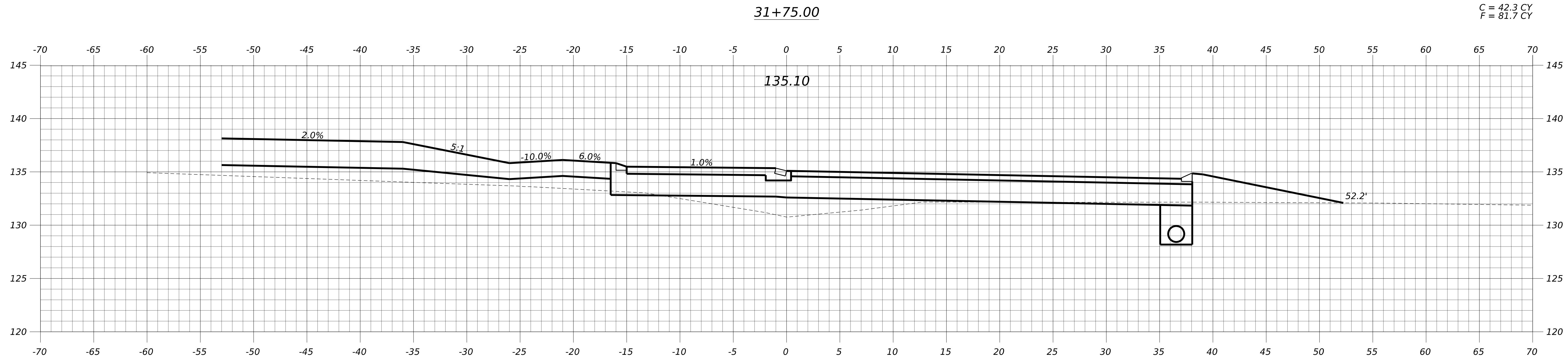
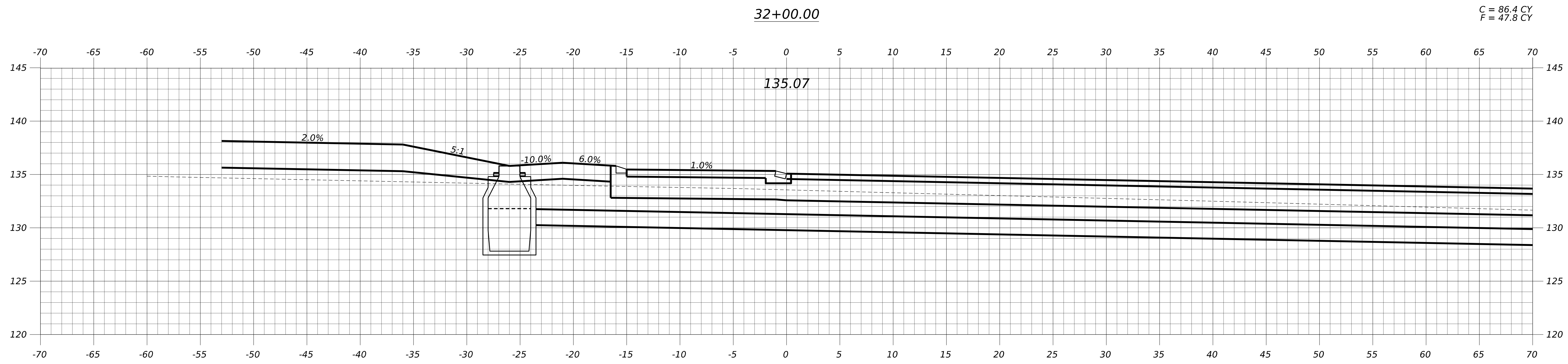
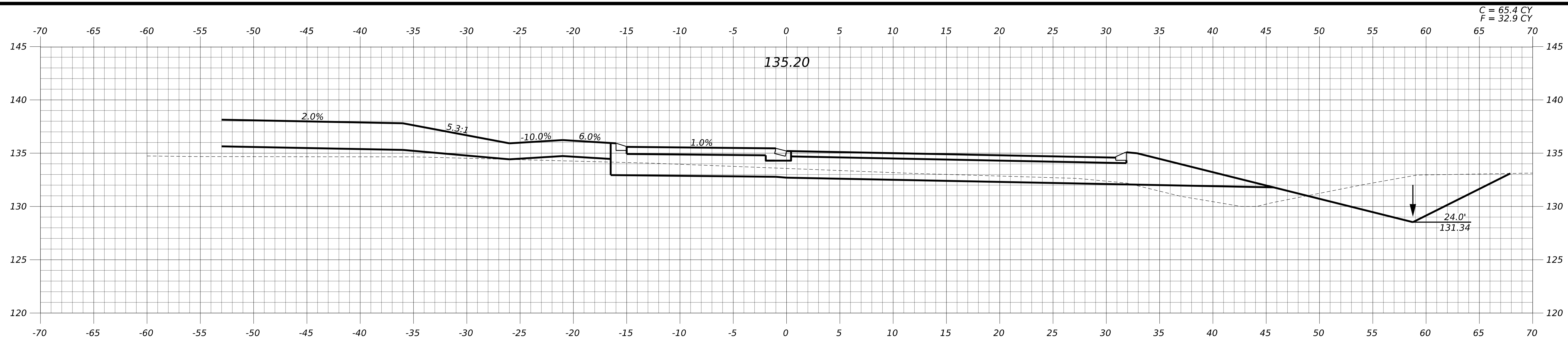

STATE OF MAINE
DEPARTMENT OF TRANSPORTATION

WIN
27036.00
HIGHWAY PLANS

PROJ. M-N-GER	BY	D-TE	SIGNATURE	P.E. NUMBER	DATE
DESIGN-DET-LED					
CHECKED-REVIEWED					
DESIGN-DET-LED02					
DESIGN-DET-LED03					
REVISIONS 1					
REVISIONS 2					
REVISIONS 3					
REVISIONS 4					
FIELD CHANGES					

WARREN
ROUTE 90 AT WESTERN RD
CROSS SECTIONS

SHEET NUMBER
62
OF 64

Date: 2005/09/07

Username: \$user\$

Division:

Filename: c:\pw_pi\strongwa\4321790\040_cross_sections.dgn

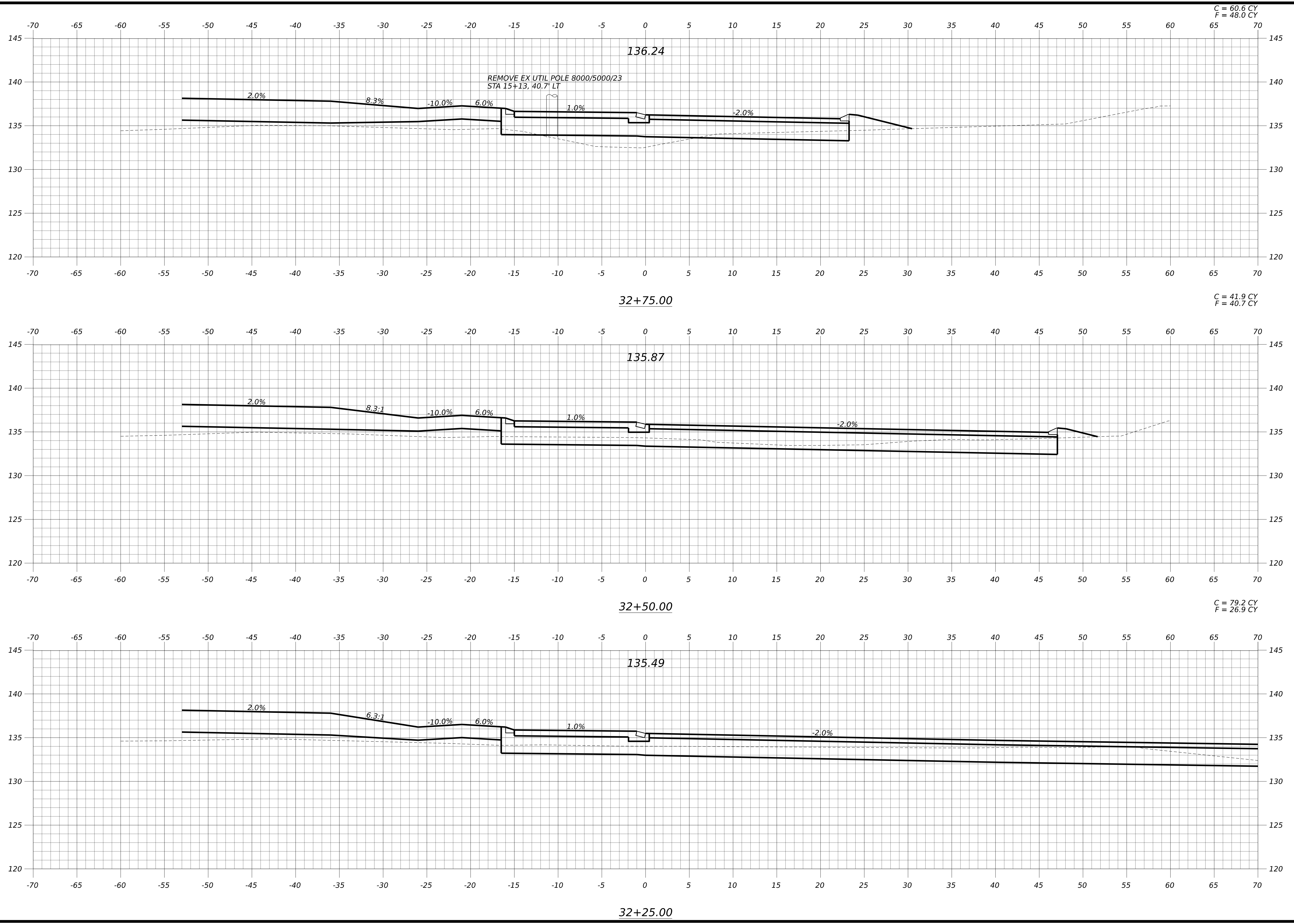

STATE OF MAINE
DEPARTMENT OF TRANSPORTATION

WIN
27036.00
HIGHWAY PLANS

PROJ. M-N-GER	BY	D-TE	SIGNATURE	P.E. NUMBER	DATE
DESIGN-DET-LED					
CHECKED-REV-LED					
DESIGN-DET-LED					
DESIGN-DET-LED					
REVISIONS 1					
REVISIONS 2					
REVISIONS 3					
REVISIONS 4					
FIELD CHANGES					

WARREN
ROUTE 90 AT WESTERN RD
CROSS SECTIONS

SHEET NUMBER
63
OF 64

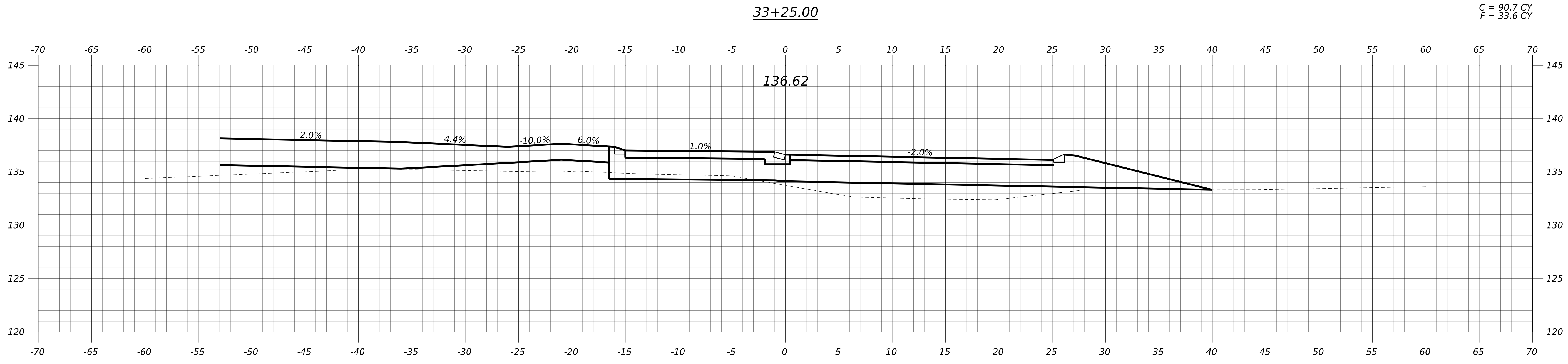
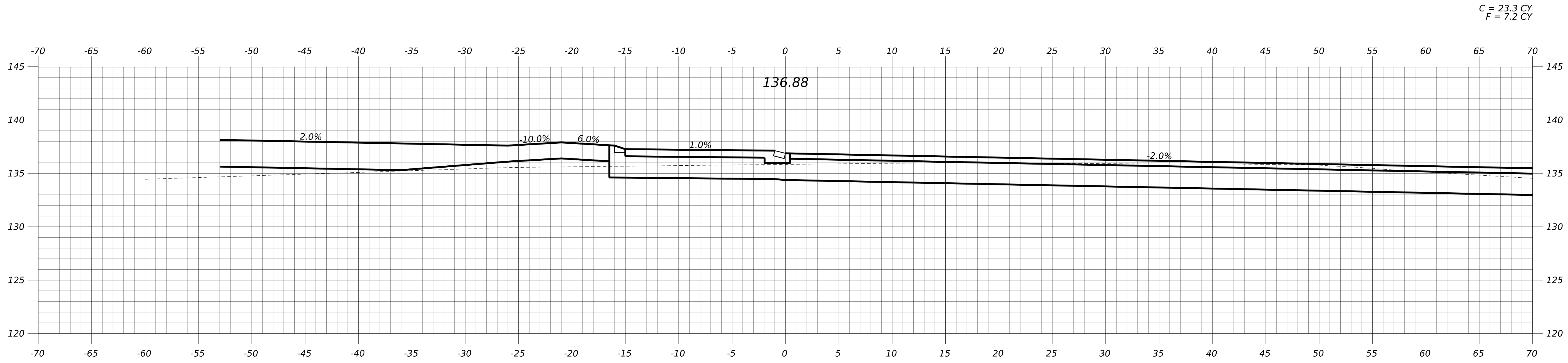

STATE OF MAINE
DEPARTMENT OF TRANSPORTATION

SIGNATURE
P.E. NUMBER
DATE

PROJ. M-N-GER
DESIGN-DET-LED
CHECKED-REVIEWED
DESIGN-DET-LED
DESIGN-DET-LED
REVISIONS 1
REVISIONS 2
REVISIONS 3
REVISIONS 4
FIELD CHANGES

WARREN
ROUTE 90 AT WESTERN RD
CROSS SECTIONS

SHEET NUMBER

64

OF 64

WIN
27036.00
HIGHWAY PLANS